



RENAISSANCE™

SPECIALISTS IN PROFESSIONAL
WINDOW FURNISHING PRODUCTS.



PRODUCT
GUIDE NO.

16





RENAISSANCE™

Renaissance specialise in professional window furnishing products. Our range offers an extensive choice of poles, tracks and blind systems all available in component form or made-to-measure to your exact specification. Whatever your window dressing requirements we provide stylish solutions with functionality you can trust.

We work across multiple sectors, supplying the hospitality & leisure industry, together with healthcare and residential establishments. At Renaissance we pride ourselves on our ability to expertly manage even the most complex of projects, consistently delivering on time, every time and within budget.

This Product Guide contains all of our Contract Solution & Deluxe Collection ranges. You can download the latest version of this guide and all Renaissance brochures on the Resources page of our website – scan the QR code below to visit now.

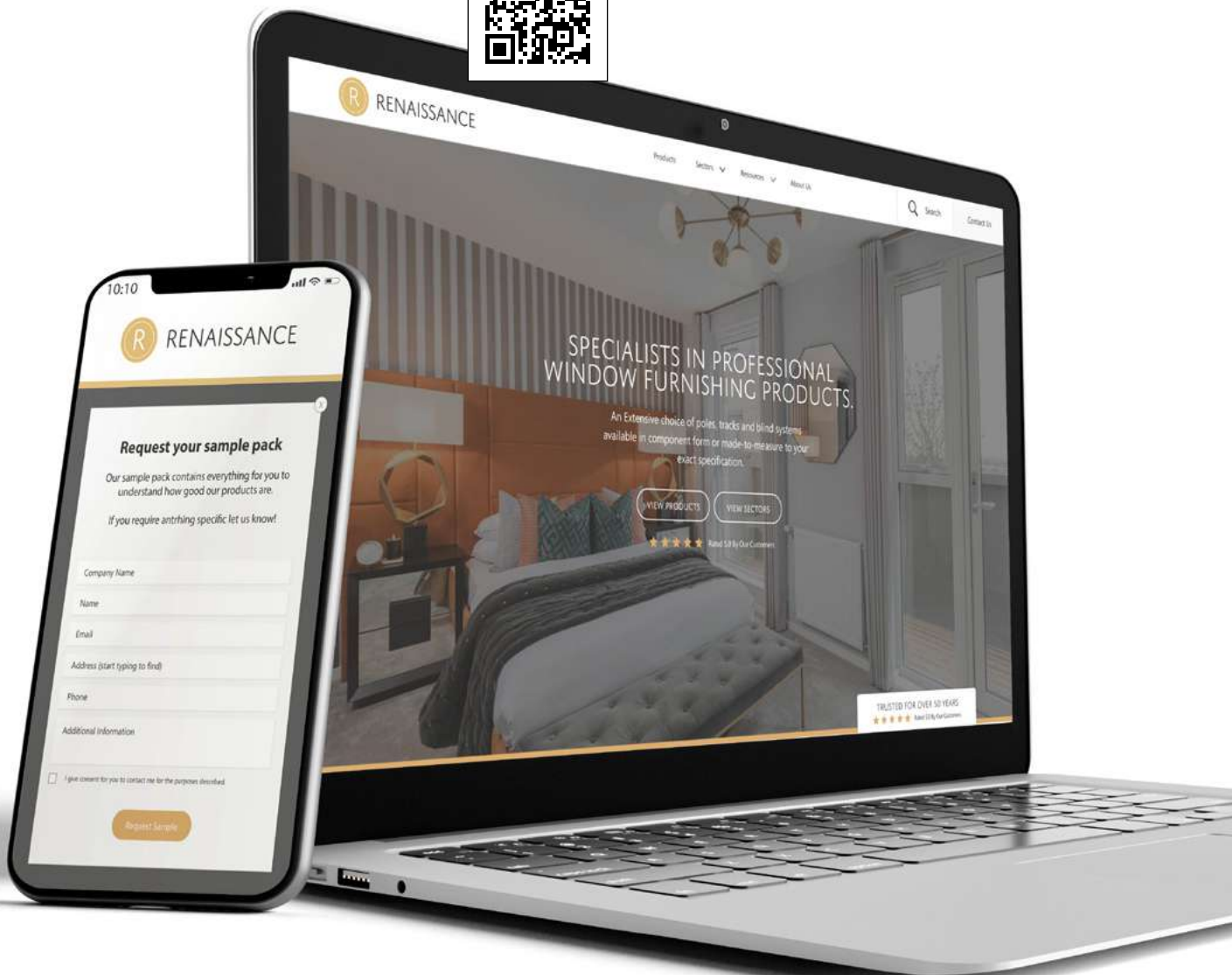

VISIT [RCA-UK.COM](https://www.rca-uk.com)

OUR PROMISE

We will provide professional window furnishing products that look great, are easy to fit, work brilliantly and last.

WHY CHOOSE US?



EXPERT ADVICE

Our product experts are always on hand to solve challenges with even the most complex window dressing solutions.



ENDLESS CHOICE

Numerous design options and colour choices so you can personalise your installation to a specification to suit you.



TAILORED FIT

Our full made-to-measure service & track bending facility ensures our products are made to your exact specification.

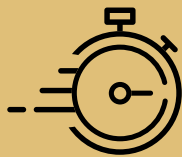

FAST DELIVERY

Need it yesterday? With large stock holding on popular products we offer next day delivery when required.



THERE & THEN

Individual tracks can be collated and labelled for ease of fitting on-site – delivered to where and when it's needed.



QUALITY ASSURED

All Renaissance products come backed with a full 5 Year Guarantee to give you complete peace of mind.

VISIT OUR WEBSITE

You can find all of our latest brochures, instructions and detailed information on our entire range of products at our website

RCA-UK.COM



FREE CARRIAGE ON ORDERS OVER £250*

REASONS TO BUY RENAISSANCE

Best value:

- We support your efficiency – 'Next Day' delivery on orders placed before 3.00pm*†
- We help you to be economic – our large stockholding and fast delivery minimises your inventory
- Save you money – volume discounts, negotiable prices and special offers
- How can we best help you?

† We will despatch goods from our warehouse on a 'Next Day' service with our couriers. Note that we cannot guarantee the couriers service.

Great Service:

- We save you time and money – Renaissance is the one source for all your curtain accessory requirements
- 'Next Day' delivery nationally on all stock products*
- We provide you extensive ranges in a choice of contract or bespoke sizes
- We supply Domestic, Commercial and Institutional Manufacturers
- Point of sale support
- National Sales representation and a dedicated service team

Reliability:

- Renaissance, the Brand for Quality Curtain Accessories
- Firm established in 1975
- An ISO 9001 (2015) registered firm
- 5 year product guarantee*
- A family firm – speak to a team that can make decisions



SERVICE & ADMINISTRATION FEES

Free 'Next Day' delivery on all orders over £250 placed before 3:00pm*

Mainland UK	Next Day Delivery	Next Day before 12:00pm	Next Day before 10:30am	Saturday Delivery
Orders over £250	FREE!	£15.00	£35.00	£65.00
Orders under £250	£17.00	£32.00	£52.00	£82.00

Residential deliveries incurs additional £10 charge.

* Subject to Terms and Conditions. See inside Back Cover for details.

COLLECTIONS & ORDER FEES

All orders under £250 will incur a small order & administration charge of £17 for 'Next Day' mainland UK.

Collection orders must be made with a minimum of 4 hours notice and also incur a small order & administration charge of £12.50.

Timed deliveries and deliveries to construction sites will vary to site requirements. POA.

ENVIRONMENTAL POLICY AND GREEN ROOTS MARK

See page 6 for more information on how we are doing our bit for a sustainable future and details on our new Green Roots mark



My Account Name

My Account No.

My Office Contact/Account Manager

Name

Direct Tel

Email

ACCOUNTS DETAILS

Payments can be made by BACS, CHAPS or Debit/Credit Card.

For accounts queries or payments please call our Finance Team on **0113 238 6952**

HEAD OFFICE ADDRESS

Renaissance,
2 Focus Business Park,
Focus Way,
Yeadon,
Leeds LS19 7DB

We're based in Leeds, close to the airport – so we'll be glad to make arrangements to collect you if you'd like to visit us.

WEBSITE

rca-uk.com

For the most up-to-date info on all our products please visit our website [Scan the QR code >](http://rca-uk.com)



FAX NUMBER





0113 238 6969



CURTAIN POLES

	Combined Wood & Metal Curtain Poles	9-26
	Handfinished Curtain Poles	27-32
	Wooden Curtain Poles	33-40
	Metal Curtain Poles	41-86

CURTAIN TRACKS

	Plastic Curtain Tracks	87-88
	Metal Curtain Tracks	89-164
	SurgeWave® System	165-180
	Multi-Channel Tracks	181-192

ROMAN BLINDS

	Roman Blind Systems & Accessories	193-204
---	-----------------------------------	---------

WORKROOM ACCESSORIES

	<p><i>Essentials™</i> Workroom Accessories</p> <p>See contents on p205 for the full listing of products</p>	205-222
	Displays & Promotion	223-225
	Forms Notes Index T&Cs	226-231



LEAN GREEN RECYCLE SCHEME

Our sourcing team is constantly reviewing our supply chain to improve our carbon footprint. Renaissance recycle all waste cardboard, plastic, steel and aluminium at our production & distribution facility.

All Renaissance cardboard and plastic despatch/display packaging is fully recyclable or biodegradable. We ensure our most popular products are available in bulk to help reduce unnecessary packaging and waste.

We are also developing our IT systems to reduce paper use and improving our online presence and download resources to reduce printed collateral.



Aluminium Tracks

Renaissance Metal Track profiles are made from Aluminium which is 100% recyclable.



Look out for our **GREEN ROOTS** mark which indicates where a product has been developed with sustainability in mind



Natur Collection

Made from 100% accredited wood the Natur range is our most sustainable Pole yet.



RENAISSANCE TM

Welcome to Renaissance and our manufacturing and distribution. We are proud of our team and production facilities in the UK – providing specialist products and expert service to meet your requirements – aligning to our company Brand Values

RELIABLE ★ CONSCIENTIOUS ★ AGILE



Product Name/
Range Name

Product
Picture

Product
Description

Stock and
Kit Sizes

Polished Silver 50mm Eyelet Pole Kits

Mirror Mosaic Ball – Polished Silver 50mm Cracked Glass Ball – Polished Silver 50mm Clear Crystal Beads – Polished Silver 50mm

50mm Spectrum Eyelet Pole Kit Sizes Available:
 1.20m (3'11") 1.50m (4'11") 1.80m (5'11") 2.40m (7'10") * Denotes 2 piece pole with joiner and includes extra bracket
 3.00m* (9'10") 3.60m* (11'10") 4.80m* (15'9") 6.00m* (19'8")

Packed: Individual Transport Packed

Kit includes:

Matching Eyelets: See this Catalogue p206-210

Product Packaging Kit Components (See key below) Complementary Accessory Products

Kit Components Key

Rings Pole Bracket – various styles as shown Finials Gliders Cord Twist End Stops

Product
Name/Range

Product
Picture

Colour & Colour
Letter Ref to add
to Product Code

Product
Description/
Components

Product
Codes

Packaging
Quantity:
px = number
of pieces/items
Outer = number of
pieces/items in a box

Minimum
Order Quantity

Professional Large Curved Aluminium Profile Track – Complete Kits

SILVER T ANTIQUE BRASS

Components	Track Kit Sizes							
	1.00m (3'3")	1.50m (4'11")	2.00m (6'7")	2.50m (8'2")	3.00m* (9'10")	4.00m* (13'1")	5.00m* (16'5")	6.00m* (19'8")
Profile Track	1 x 1.00m	1 x 1.50m	1 x 2.00m	1 x 2.50m	2 x 1.50m	2 x 2.00m	2 x 2.50m	2 x 3.00m
Brackets**	3	4	5	6	7	9	11	13
End Caps	2	2	2	2	2	2	2	2
Gliders^	10	16	20	26	30	40	50	60
Twist End Stops	2	2	2	2	2	2	2	2
Standard Kit Code †	16CK100_	16CK150_	16CK200_	16CK250_	16CK300_	16CK400_	16CK500_	16CK600_
Surge Wave Kit Code †	16CW100_	16CW150_	16CW200_	16CW250_	16CW300_	16CW400_	16CW500_	16CW600_

Packed: 1 px / Outer 5 Min Qty: 1

† Insert your chosen colour letter reference at end of the Kit Code and Surge code.

* Denotes 2 piece profile with joiner. All kits include fittings. ** Brackets are 4cm Leverlock Wall/Ceiling Brackets. ^For Surge the gliders are replaced with gliders on a string

Curtain
Weight
Advice

Colour
Finishes
Available

Bending Options Packaging/Delivery Contract Options Kit Availability Made-to-Measure

KG MEDIUM HEAVY This curtain track is suitable for medium to heavy weight curtains

Suitable for straight runs and can also be bent

Kits/components are delivered in transport or retail packaging

Available in contract components for large jobs

Available in kit form for simple ordering

Tracks available made-to-measure

BLACK NICKEL ANTIQUE BRASS POLISHED SILVER TITANIUM



RENAISSANCE



COMBINED WOOD & METAL CURTAIN POLES



COMBINED WOOD & METAL CURTAIN POLES



Accents Range

It's time to discover your perfect combination with the Accents Range from Renaissance – a contemporary mix of wooden curtain poles and stunning metal accessories. Choose your 35mm or 50mm real wood pole colour, then pair from a selection of contrasting glass or metal finial designs with matching brackets and rings.

With 24 colour combinations ready to discover you'll be sure to find an Accents that's perfect for your interior.

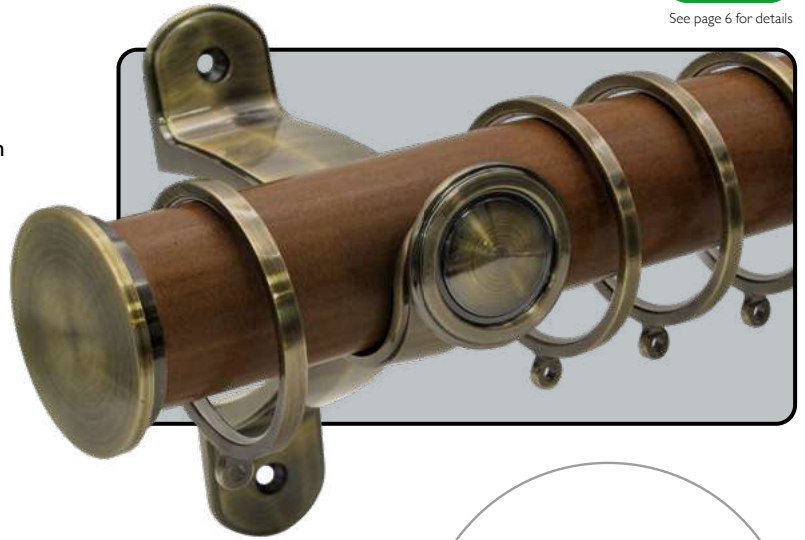

35mm Contemporary Bracket Kit with Crystal Cut Diamond Finial
Available for 35mm poles only.



50mm Luxury Bracket Kit with **NEW** Ribbed Ball Finial

new

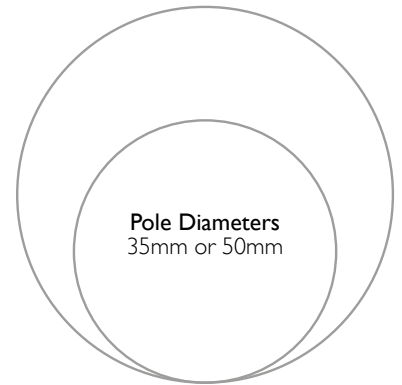

Pole Diameters
35mm or 50mm

Metal Finials & Accessories Colour finishes available:

BLACK NICKEL

POLISHED SILVER

ANTIQUE BRASS

TITANIUM

Combine with your chosen Wooden Pole colour:

CHALK WHITE

COAL BLACK

SLATE GREY

COTTON CREAM

DARK OAK

MID OAK

Kit Components

Single length poles available up to 3.00m on request

Components	Pole Kit Sizes							
	1.20m (3'11")	1.50m (4'11")	1.80m (5'11")	2.40m* (7'10")	3.00m* (9'10")	3.60m* (11'10")	4.80m* (15'9")	6.00m* (19'8") [†]
Pole	1 x 1.20m	1 x 1.50m	1 x 1.80m	1 x 2.40m	2 x 1.50m	2 x 1.80m	2 x 2.40m	2 x 3.00m
End Brackets	2	2	2	2	2	2	2	2
Centre Brackets	-	-	-	1	1	1	1	1
Finials	2	2	2	2	2	2	2	2
Rings	12	16	18	24	30	36	48	60

Complete Pole Kits available ensuring your purchase is quick, simple and hassle free. [†] 6.00m kits are for 50mm only.

* 2 piece pole with joiner and includes centre bracket. **NOTE:** 2.40 and 3.00m single length poles are available to special order and **must** be specified at point of order.



This curtain pole is suitable for medium-to-heavy weight curtains



Suitable for straight runs only



Kits/components are delivered in transport packaging



Mix-and-match bespoke colour combination



Available in kit form for simple ordering



Poles available made-to-measure

DISCLAIMER: Whilst every effort has been made to ensure colour accuracy, due to the limitations of colour printing, please refer to product samples for colour matching. Product dimensions are for guidance only and may differ – please confirm details at time of ordering.

Accents

Finials



FYNN
Black Nickel



Smoked Crystal Beads
Black Nickel



Clear Crystal Cut Diamond
Black Nickel



Plain Ball
Black Nickel



Ribbed Ball
Black Nickel



FYNN
Polished Silver



Crackled Glass Ball
Polished Silver



Crystal Clear Beads
Polished Silver



Plain Ball
Polished Silver



Ribbed Ball
Polished Silver



Clear Crystal Cut Diamond
Polished Silver



FYNN
Antique Brass



Plain Ball
Antique Brass



Ribbed Ball
Antique Brass



Crackled Glass Ball
Titanium



FYNN
Titanium



Clear Crystal Beads
Titanium



Plain Ball
Titanium



Ribbed Ball
Titanium



Clear Crystal Cut Diamond
Titanium

Brackets



Luxury Bracket



Contemporary Bracket (Available 35mm Only)

Combine with your chosen Wooden Pole colour from these finishes available:

CHALK WHITE

COAL BLACK

SLATE GREY

COTTON CREAM

DARK OAK

MID OAK

DISCLAIMER: Whilst every effort has been made to ensure colour accuracy, due to the limitations of colour printing, please refer to product samples for colour matching. Product dimensions are for guidance only and may differ – please confirm details at time of ordering.

Accents – Luxury Brackets

Titanium 35mm or 50mm Complete Kits



Titanium/Slate Grey 35mm or 50mm FYNN Finial



Titanium/Chalk White 35mm or 50mm FYNN Finial



Titanium/Dark Oak 35mm or 50mm FYNN Finial



Titanium/Cotton Cream 35mm or 50mm FYNN Finial



Titanium/Coal Black 35mm or 50mm FYNN Finial



Titanium/Mid Oak 35mm or 50mm FYNN Finial



Titanium/Slate Grey 35mm or 50mm Plain Ball Finial



Titanium/Chalk White 35mm or 50mm Plain Ball Finial



Titanium/Dark Oak 35mm or 50mm Plain Ball Finial



Titanium/Cotton Cream 35mm or 50mm Plain Ball Finial



Titanium/Coal Black 35mm Plain Ball Finial



Titanium/Mid Oak 35mm or 50mm Plain Ball Finial



Titanium/Slate Grey 35mm or 50mm Clear Crystal Cut Diamond Finial



Titanium/Chalk White 35mm or 50mm Clear Crystal Cut Diamond Finial



Titanium/Dark Oak 35mm or 50mm Clear Crystal Cut Diamond Finial



Titanium/Cotton Cream 35mm or 50mm Clear Crystal Cut Diamond Finial



Titanium/Coal Black 35mm or 50mm Clear Crystal Cut Diamond Finial



Titanium/Mid Oak 35mm or 50mm Clear Crystal Cut Diamond Finial

Accents Complete Kit Sizes Available:

1.20m (3'11") 1.50m (4'11") 1.80m (5'11") 2.40m* (7'10")
 3.00m* (9'10") 3.60m* (11'10") 4.80m* (15'9") 6.00m* (19'8") †

* Denotes 2 piece pole with joiner and includes extra bracket

Packed:

Individual



Transport Packed

Kit includes:



NOTE: 2.40 and 3.00m single length poles are available to special order and **must** be specified at point of order.

DISCLAIMER: Whilst every effort has been made to ensure colour accuracy, due to the limitations of colour printing, please refer to product samples for colour matching. Product dimensions are for guidance only and may differ – please confirm details at time of ordering.

Accents – Luxury Brackets

Titanium 35mm or 50mm Complete Kits



Titanium/Slate Grey 35mm or 50mm
Cracked Glass Ball Finial



Titanium/Chalk White 35mm or 50mm
Cracked Glass Ball Finial



Titanium/Dark Oak 35mm or 50mm
Cracked Glass Ball Finial



Titanium/Cotton Cream 35mm or 50mm
Cracked Glass Ball Finial



Titanium/Coal Black 35mm or 50mm
Cracked Glass Ball Finial



Titanium/Mid Oak 35mm or 50mm
Cracked Glass Ball Finial



Titanium/Slate Grey 35mm or 50mm
Clear Crystal Beads Finial



Titanium/Chalk White 35mm or 50mm
Clear Crystal Beads Finial



Titanium/Dark Oak 35mm or 50mm
Clear Crystal Beads Finial



Titanium/Cotton Cream 35mm or 50mm
Clear Crystal Beads Finial



Titanium/Coal Black 35mm or 50mm
Clear Crystal Beads Finial



Titanium/Mid Oak 35mm or 50mm
Clear Crystal Beads Finial



Titanium/Slate Grey 35mm or 50mm
Ribbed Ball Finial



Titanium/Chalk White 35mm or 50mm
Ribbed Ball Finial



Titanium/Dark Oak 35mm or 50mm
Ribbed Ball Finial



Titanium/Cotton Cream 35mm or 50mm Clear
Ribbed Ball Finial



Titanium/Coal Black 35mm or 50mm
Ribbed Ball Finial



Titanium/Mid Oak 35mm or 50mm
Ribbed Ball Finial

Accents Complete Kit Sizes Available:

1.20m (3'11") 1.50m (4'11") 1.80m (5'11") 2.40m* (7'10")
3.00m* (9'10") 3.60m* (11'10") 4.80m* (15'9") 6.00m* (19'8") †

* Denotes 2 piece pole with joiner and includes extra bracket

Packed:

Individual



Transport Packed

Kit includes:



NOTE: 2.40 and 3.00m single length poles are available to special order and **must** be specified at point of order.

DISCLAIMER: Whilst every effort has been made to ensure colour accuracy, due to the limitations of colour printing, please refer to product samples for colour matching. Product dimensions are for guidance only and may differ – please confirm details at time of ordering.



Accents – Luxury Brackets

Black Nickel 35mm or 50mm Complete Kits



Black Nickel/Slate Grey 35mm or 50mm FYNN Finial



Black Nickel/Chalk White 35mm or 50mm FYNN Finial



Black Nickel/Dark Oak 35mm or 50mm FYNN Finial



Black Nickel/Cotton Cream 35mm or 50mm FYNN Finial



Black Nickel/Coal Black 35mm or 50mm FYNN Finial



Black Nickel/Mid Oak 35mm or 50mm FYNN Finial



Black Nickel/Slate Grey 35mm or 50mm Plain Ball Finial



Black Nickel/Chalk White 35mm or 50mm Plain Ball Finial



Black Nickel/Dark Oak 35mm or 50mm Plain Ball Finial



Black Nickel/Cotton Cream 35mm or 50mm Plain Ball Finial



Black Nickel/Coal Black 35mm or 50mm Plain Ball Finial



Black Nickel/Mid Oak 35mm or 50mm Plain Ball Finial



Black Nickel/Slate Grey 35mm or 50mm Clear Crystal Cut Diamond Finial



Black Nickel/Chalk White 35mm or 50mm Clear Crystal Cut Diamond Finial



Black Nickel/Dark Oak 35mm or 50mm Clear Crystal Cut Diamond Finial



Black Nickel/Cotton Cream 35mm or 50mm Clear Crystal Cut Diamond Finial



Black Nickel/Coal Black 35mm Clear Crystal Cut Diamond Finial



Black Nickel/Mid Oak 35mm or 50mm Clear Crystal Cut Diamond Finial

Accents Complete Kit Sizes Available:

1.20m (3'11") 1.50m (4'11") 1.80m (5'11") 2.40m* (7'10")
 3.00m* (9'10") 3.60m* (11'10") 4.80m* (15'9") 6.00m* (19'8") †

* Denotes 2 piece pole with joiner and includes extra bracket

Packed:

Individual



Transport Packed

Kit includes:



NOTE: 2.40 and 3.00m single length poles are available to special order and **must** be specified at point of order.

DISCLAIMER: Whilst every effort has been made to ensure colour accuracy, due to the limitations of colour printing, please refer to product samples for colour matching. Product dimensions are for guidance only and may differ – please confirm details at time of ordering.

Accents – Luxury Brackets

Black Nickel 35mm or 50mm Complete Kits



Black Nickel/Slate Grey 35mm or 50mm
Smoked Crystal Beads Finial



Black Nickel/Chalk White 35mm or 50mm
Smoked Crystal Beads Finial



Black Nickel/Dark Oak 35mm or 50mm
Smoked Crystal Beads Finial



Black Nickel/Cotton Cream 35mm or 50mm
Smoked Crystal Beads Finial



Black Nickel/Coal Black 35mm or 50mm
Smoked Crystal Beads Finial



Black Nickel/Mid Oak 35mm or 50mm
Smoked Crystal Beads Finial



Black Nickel/Slate Grey 35mm or 50mm
Ribbed Ball Finial



Black Nickel/Chalk White 35mm or 50mm
Ribbed Ball Finial



Black Nickel/Dark Oak 35mm or 50mm
Ribbed Ball Finial



Black Nickel/Cotton Cream 35mm or 50mm
Ribbed Ball Finial



Black Nickel/Coal Black 35mm or 50mm
Ribbed Ball Finial



Black Nickel/Mid Oak 35mm or 50mm
Ribbed Ball Finial

Accents Complete Kit Sizes Available:

1.20m (3'11") 1.50m (4'11") 1.80m (5'11") 2.40m* (7'10")
3.00m* (9'10") 3.60m* (11'10") 4.80m* (15'9") 6.00m* (19'8") †

* Denotes 2 piece
pole with joiner and
includes extra bracket

Packed:
Individual



Transport Packed

Kit includes:



NOTE: 2.40 and 3.00m single length poles are available to special order and **must** be specified at point of order.

DISCLAIMER: Whilst every effort has been made to ensure colour accuracy, due to the limitations of colour printing, please refer to product samples for colour matching. Product dimensions are for guidance only and may differ – please confirm details at time of ordering.



RENAISSANCE

TEL 0113 250 4499

• EMAIL SALES@RCA-UK.COM

• VISIT RCA-UK.COM

Accents – Luxury Brackets

Polished Silver 35mm or 50mm Complete Kits



Polished Silver/Slate Grey 35mm or 50mm FYNN Finial



Polished Silver/Chalk White 35mm or 50mm FYNN Finial



Polished Silver/Dark Oak 35mm or 50mm FYNN Finial



Polished Silver/Cotton Cream 35mm or 50mm FYNN Finial



Polished Silver/Coal Black 35mm or 50mm FYNN Finial



Polished Silver/Mid Oak 35mm or 50mm FYNN Finial



Polished Silver/Slate Grey 35mm or 50mm Plain Ball Finial



Polished Silver/Chalk White 35mm or 50mm Plain Ball Finial



Polished Silver/Dark Oak 35mm or 50mm Plain Ball Finial



Polished Silver/Cotton Cream 35mm or 50mm Plain Ball Finial



Polished Silver/Coal Black 35mm or 50mm Plain Ball Finial



Polished Silver/Mid Oak 35mm or 50mm Plain Ball Finial



Polished Silver/Slate Grey 35mm or 50mm Clear Crystal Cut Diamond Finial



Polished Silver/Chalk White 35mm or 50mm Clear Crystal Cut Diamond Finial



Polished Silver/Dark Oak 35mm or 50mm Clear Crystal Cut Diamond Finial



Polished Silver/Cotton Cream 35mm or 50mm Clear Crystal Cut Diamond Finial



Polished Silver/Coal Black 35mm or 50mm Clear Crystal Cut Diamond Finial



Polished Silver/Mid Oak 35mm or 50mm Clear Crystal Cut Diamond Finial

Accents Complete Kit Sizes Available:

1.20m (3'11") 1.50m (4'11") 1.80m (5'11") 2.40m* (7'10")
 3.00m* (9'10") 3.60m* (11'10") 4.80m* (15'9") 6.00m* (19'8") †

* Denotes 2 piece pole with joiner and includes extra bracket

Packed:

Individual



Transport Packed

Kit includes:



NOTE: 2.40 and 3.00m single length poles are available to special order and **must** be specified at point of order.

DISCLAIMER: Whilst every effort has been made to ensure colour accuracy, due to the limitations of colour printing, please refer to product samples for colour matching. Product dimensions are for guidance only and may differ – please confirm details at time of ordering.

Accents – Luxury Brackets

Polished Silver 35mm or 50mm Complete Kits



Polished Silver/Slate Grey 35mm or 50mm
Cracked Glass Ball Finial



Polished Silver/Chalk White 35mm or 50mm
Cracked Glass Ball Finial



Polished Silver/Dark Oak 35mm or 50mm
Cracked Glass Ball Finial



Polished Silver/Cotton Cream 35mm or 50mm
Cracked Glass Ball Finial



Polished Silver/Coal Black 35mm or 50mm
Cracked Glass Ball Finial



Polished Silver/Mid Oak 35mm or 50mm
Cracked Glass Ball Finial



Polished Silver/Slate Grey 35mm or 50mm
Clear Crystal Beads Finial



Polished Silver/Chalk White 35mm or 50mm
Clear Crystal Beads Finial



Polished Silver/Dark Oak 35mm or 50mm
Clear Crystal Beads Finial



Polished Silver/Cotton Cream 35mm or 50mm
Clear Crystal Beads Finial



Polished Silver/Coal Black 35mm or 50mm
Clear Crystal Beads Finial



Polished Silver/Mid Oak 35mm or 50mm
Clear Crystal Beads Finial



Polished Silver/Slate Grey 35mm or 50mm
Ribbed Ball Finial



Polished Silver/Chalk White 35mm or 50mm
Ribbed Ball Finial



Polished Silver/Dark Oak 35mm or 50mm
Ribbed Ball Finial



Polished Silver/Cotton Cream 35mm or 50mm
Ribbed Ball Finial



Polished Silver/Coal Black 35mm or 50mm
Ribbed Ball Finial



Polished Silver/Mid Oak 35mm or 50mm
Ribbed Ball Finial

Accents Complete Kit Sizes Available:

1.20m (3'11") 1.50m (4'11") 1.80m (5'11") 2.40m* (7'10")
3.00m* (9'10") 3.60m* (11'10") 4.80m* (15'9") 6.00m* (19'8") †

* Denotes 2 piece pole with joiner and includes extra bracket

Packed:

Individual



Transport Packed

Kit includes:



NOTE: 2.40 and 3.00m single length poles are available to special order and **must** be specified at point of order.

DISCLAIMER: Whilst every effort has been made to ensure colour accuracy, due to the limitations of colour printing, please refer to product samples for colour matching. Product dimensions are for guidance only and may differ – please confirm details at time of ordering.



Accents – Luxury Brackets

Antique Brass 35mm or 50mm Complete Kits



Antique Brass/Slate Grey 35mm or 50mm FYNN Finial



Antique Brass/Chalk White 35mm or 50mm FYNN Finial



Antique Brass/Dark Oak 35mm or 50mm FYNN Finial



Antique Brass/Cotton Cream 35mm or 50mm FYNN Finial



Antique Brass/Coal Black 35mm or 50mm FYNN Finial



Antique Brass/Mid Oak 35mm or 50mm FYNN Finial



Antique Brass/Slate Grey 35mm or 50mm Plain Ball Finial



Antique Brass/Chalk White 35mm or 50mm Plain Ball Finial



Antique Brass/Dark Oak 35mm or 50mm Plain Ball Finial



Antique Brass/Cotton Cream 35mm or 50mm Plain Ball Finial



Antique Brass/Coal Black 35mm or 50mm Plain Ball Finial



Antique Brass/Mid Oak 35mm or 50mm Plain Ball Finial



Antique Brass/Slate Grey 35mm or 50mm Ribbed Ball Finial



Antique Brass/Chalk White 35mm or 50mm Ribbed Ball Finial



Antique Brass/Dark Oak 35mm or 50mm Ribbed Ball Finial



Antique Brass/Cotton Cream 35mm or 50mm Ribbed Ball Finial



Antique Brass/Coal Black 35mm or 50mm Ribbed Ball Finial



Antique Brass/Mid Oak 35mm or 50mm Ribbed Ball Finial

Accents Complete Kit Sizes Available:

1.20m (3'11") 1.50m (4'11") 1.80m (5'11") 2.40m* (7'10")
 3.00m* (9'10") 3.60m* (11'10") 4.80m* (15'9") 6.00m* (19'8") †

* Denotes 2 piece pole with joiner and includes extra bracket

Packed:

Individual



Transport Packed

Kit includes:



NOTE: 2.40 and 3.00m single length poles are available to special order and **must** be specified at point of order.

DISCLAIMER: Whilst every effort has been made to ensure colour accuracy, due to the limitations of colour printing, please refer to product samples for colour matching. Product dimensions are for guidance only and may differ – please confirm details at time of ordering.



COMBINED WOOD & METAL CURTAIN POLES



RENAISSANCE

TEL 0113 250 4499



EMAIL SALES@RCA-UK.COM



VISIT RCA-UK.COM

Accents 35mm – Contemporary Brackets

Titanium 35mm Complete Kits



Titanium/Slate Grey 35mm
FYNN Finial



Titanium/Chalk White 35mm
FYNN Finial



Titanium/Dark Oak 35mm
FYNN Finial



Titanium/Cotton Cream 35mm
FYNN Finial



Titanium/Coal Black 35mm
FYNN Finial



Titanium/Mid Oak 35mm
FYNN Finial



Titanium/Slate Grey 35mm
Plain Ball Finial



Titanium/Chalk White 35mm
Plain Ball Finial



Titanium/Dark Oak 35mm
Plain Ball Finial



Titanium/Cotton Cream 35mm
Plain Ball Finial



Titanium/Coal Black 35mm
Plain Ball Finial



Titanium/Mid Oak 35mm
Plain Ball Finial



Titanium/Slate Grey 35mm
Clear Crystal Cut Diamond Finial



Titanium/Chalk White 35mm
Clear Crystal Cut Diamond Finial



Titanium/Dark Oak 35mm
Clear Crystal Cut Diamond Finial



Titanium/Cotton Cream 35mm
Clear Crystal Cut Diamond Finial



Titanium/Coal Black 35mm
Clear Crystal Cut Diamond Finial



Titanium/Mid Oak 35mm
Clear Crystal Cut Diamond Finial

35mm Accents Complete Kit Sizes Available:

1.20m (3'11") 1.50m (4'11") 1.80m (5'11") 2.40m* (7'10")
3.00m* (9'10") 3.60m* (11'10") 4.80m* (15'9")

* Denotes 2 piece pole with joiner and includes extra bracket

Packed:

Individual



Transport Packed

Kit includes:



NOTE: 2.40 and 3.00m single length poles are available to special order and **must** be specified at point of order.

DISCLAIMER: Whilst every effort has been made to ensure colour accuracy, due to the limitations of colour printing, please refer to product samples for colour matching. Product dimensions are for guidance only and may differ – please confirm details at time of ordering.

Accents 35mm – Contemporary Brackets

Titanium 35mm Complete Kits



Titanium/Slate Grey 35mm
Cracked Glass Ball Finial



Titanium/Chalk White 35mm
Cracked Glass Ball Finial



Titanium/Dark Oak 35mm
Cracked Glass Ball Finial



Titanium/Cotton Cream 35mm
Cracked Glass Ball Finial



Titanium/Coal Black 35mm
Cracked Glass Ball Finial



Titanium/Mid Oak 35mm
Cracked Glass Ball Finial



Titanium/Slate Grey 35mm
Clear Crystal Beads Finial



Titanium/Chalk White 35mm
Clear Crystal Beads Finial



Titanium/Dark Oak 35mm
Clear Crystal Beads Finial



Titanium/Cotton Cream 35mm
Clear Crystal Beads Finial



Titanium/Coal Black 35mm
Clear Crystal Beads Finial



Titanium/Mid Oak 35mm
Clear Crystal Beads Finial



Titanium/Slate Grey 35mm
Ribbed Ball Finial



Titanium/Chalk White 35mm
Ribbed Ball Finial



Titanium/Dark Oak 35mm
Ribbed Ball Finial



Titanium/Cotton Cream 35mm
Ribbed Ball Finial



Titanium/Coal Black 35mm
Ribbed Ball Finial



Titanium/Mid Oak 35mm
Ribbed Ball Finial

35mm Accents Complete Kit Sizes Available:

1.20m (3'11") 1.50m (4'11") 1.80m (5'11") 2.40m* (7'10")
3.00m* (9'10") 3.60m* (11'10") 4.80m* (15'9")

* Denotes 2 piece pole with joiner and includes extra bracket

Packed:

Individual



Transport Packed

Kit includes:



NOTE: 2.40 and 3.00m single length poles are available to special order and **must** be specified at point of order.

DISCLAIMER: Whilst every effort has been made to ensure colour accuracy, due to the limitations of colour printing, please refer to product samples for colour matching. Product dimensions are for guidance only and may differ – please confirm details at time of ordering.



Accents 35mm – Contemporary Brackets

Black Nickel 35mm Complete Kits



Black Nickel/Slate Grey 35mm
FYNN Finial



Black Nickel/Chalk White 35mm
FYNN Finial



Black Nickel/Dark Oak 35mm
FYNN Finial



Black Nickel/Cotton Cream 35mm
FYNN Finial



Black Nickel/Coal Black 35mm
FYNN Finial



Black Nickel/Mid Oak 35mm
FYNN Finial



Black Nickel/Slate Grey 35mm
Plain Ball Finial



Black Nickel/Chalk White 35mm
Plain Ball Finial



Black Nickel/Dark Oak 35mm
Plain Ball Finial



Black Nickel/Cotton Cream 35mm
Plain Ball Finial



Black Nickel/Coal Black 35mm
Plain Ball Finial



Black Nickel/Mid Oak 35mm
Plain Ball Finial



Black Nickel/Slate Grey 35mm
Clear Crystal Cut Diamond Finial



Black Nickel/Chalk White 35mm
Clear Crystal Cut Diamond Finial



Black Nickel/Dark Oak 35mm
Clear Crystal Cut Diamond Finial



Black Nickel/Cotton Cream 35mm
Clear Crystal Cut Diamond Finial



Black Nickel/Coal Black 35mm
Clear Crystal Cut Diamond Finial



Black Nickel/Mid Oak 35mm
Clear Crystal Cut Diamond Finial

35mm Accents Complete Kit Sizes Available:

1.20m (3'11") 1.50m (4'11") 1.80m (5'11") 2.40m* (7'10")
3.00m* (9'10") 3.60m* (11'10") 4.80m* (15'9")

* Denotes 2 piece pole with joiner and includes extra bracket

Packed:

Individual



Transport Packed

Kit includes:



NOTE: 2.40 and 3.00m single length poles are available to special order and **must** be specified at point of order.

DISCLAIMER: Whilst every effort has been made to ensure colour accuracy, due to the limitations of colour printing, please refer to product samples for colour matching. Product dimensions are for guidance only and may differ – please confirm details at time of ordering.

Accents 35mm – Contemporary Brackets

Black Nickel 35mm Complete Kits



Black Nickel/Slate Grey 35mm
Smoked Crystal Beads Finial



Black Nickel/Chalk White 35mm
Smoked Crystal Beads Finial



Black Nickel/Dark Oak 35mm
Smoked Crystal Beads Finial



Black Nickel/Cotton Cream 35mm
Smoked Crystal Beads Finial



Black Nickel/Coal Black 35mm
Smoked Crystal Beads Finial



Black Nickel/Mid Oak 35mm
Smoked Crystal Beads Finial



Black Nickel/Slate Grey 35mm
Ribbed Ball Finial



Black Nickel/Chalk White 35mm
Ribbed Ball Finial



Black Nickel/Dark Oak 35mm
Ribbed Ball Finial



Black Nickel/Cotton Cream 35mm
Ribbed Ball Finial



Black Nickel/Coal Black 35mm
Ribbed Ball Finial



Black Nickel/Mid Oak 35mm
Ribbed Ball Finial

35mm Accents Complete Kit Sizes Available:

1.20m (3'11") 1.50m (4'11") 1.80m (5'11") 2.40m* (7'10")
3.00m* (9'10") 3.60m* (11'10") 4.80m* (15'9")

* Denotes 2 piece
pole with joiner and
includes extra bracket

Packed:
Individual



Transport Packed

Kit includes:



NOTE: 2.40 and 3.00m single length poles are available to special order and **must** be specified at point of order.

DISCLAIMER: Whilst every effort has been made to ensure colour accuracy, due to the limitations of colour printing, please refer to product samples for colour matching. Product dimensions are for guidance only and may differ – please confirm details at time of ordering.



RENAISSANCE

TEL 0113 250 4499

• EMAIL SALES@RCA-UK.COM

• VISIT RCA-UK.COM

Accents 35mm – Contemporary Brackets

Polished Silver 35mm Complete Kits



Polished Silver/Slate Grey 35mm
FYNN Finial



Polished Silver/Chalk White 35mm
FYNN Finial



Polished Silver/Dark Oak 35mm
FYNN Finial



Polished Silver/Cotton Cream 35mm
FYNN Finial



Polished Silver/Coal Black 35mm
FYNN Finial



Polished Silver/Mid Oak 35mm
FYNN Finial



Polished Silver/Slate Grey 35mm
Plain Ball Finial



Polished Silver/Chalk White 35mm
Plain Ball Finial



Polished Silver/Dark Oak 35mm
Plain Ball Finial



Polished Silver/Cotton Cream 35mm
Plain Ball Finial



Polished Silver/Coal Black 35mm
Plain Ball Finial



Polished Silver/Mid Oak 35mm
Plain Ball Finial



Polished Silver/Slate Grey 35mm
Clear Crystal Cut Diamond Finial



Polished Silver/Chalk White 35mm
Clear Crystal Cut Diamond Finial



Polished Silver/Dark Oak 35mm
Clear Crystal Cut Diamond Finial



Polished Silver/Cotton Cream 35mm
Clear Crystal Cut Diamond Finial



Polished Silver/Coal Black 35mm
Clear Crystal Cut Diamond Finial



Polished Silver/Mid Oak 35mm
Clear Crystal Cut Diamond Finial

35mm Accents Complete Kit Sizes Available:

1.20m (3'11") 1.50m (4'11") 1.80m (5'11") 2.40m* (7'10")
3.00m* (9'10") 3.60m* (11'10") 4.80m* (15'9")

* Denotes 2 piece pole with joiner and includes extra bracket

Packed:

Individual



Transport Packed

Kit includes:



NOTE: 2.40 and 3.00m single length poles are available to special order and **must** be specified at point of order.

DISCLAIMER: Whilst every effort has been made to ensure colour accuracy, due to the limitations of colour printing, please refer to product samples for colour matching. Product dimensions are for guidance only and may differ – please confirm details at time of ordering.

Accents 35mm – Contemporary Brackets

Polished Silver 35mm Complete Kits



Polished Silver/Slate Grey 35mm
Cracked Glass Ball Finial



Polished Silver/Chalk White 35mm
Cracked Glass Ball Finial



Polished Silver/Dark Oak 35mm
Cracked Glass Ball Finial



Polished Silver/Cotton Cream 35mm
Cracked Glass Ball Finial



Polished Silver/Coal Black 35mm
Cracked Glass Ball Finial



Polished Silver/Mid Oak 35mm
Cracked Glass Ball Finial



Polished Silver/Slate Grey 35mm
Clear Crystal Beads Finial



Polished Silver/Chalk White 35mm
Clear Crystal Beads Finial



Polished Silver/Dark Oak 35mm
Clear Crystal Beads Finial



Polished Silver/Cotton Cream 35mm
Clear Crystal Beads Finial



Polished Silver/Coal Black 35mm
Clear Crystal Beads Finial



Polished Silver/Mid Oak 35mm
Clear Crystal Beads Finial



Polished Silver/Slate Grey 35mm
Ribbed Ball Finial



Polished Silver/Chalk White 35mm
Ribbed Ball Finial



Polished Silver/Dark Oak 35mm
Ribbed Ball Finial



Polished Silver/Cotton Cream 35mm
Ribbed Ball Finial



Polished Silver/Coal Black 35mm
Ribbed Ball Finial



Polished Silver/Mid Oak 35mm
Ribbed Ball Finial

35mm Accents Complete Kit Sizes Available:

1.20m (3'11") 1.50m (4'11") 1.80m (5'11") 2.40m* (7'10")
3.00m* (9'10") 3.60m* (11'10") 4.80m* (15'9")

* Denotes 2 piece pole with joiner and includes extra bracket

Packed:

Individual



Transport Packed

Kit includes:



NOTE: 2.40 and 3.00m single length poles are available to special order and **must** be specified at point of order.

DISCLAIMER: Whilst every effort has been made to ensure colour accuracy, due to the limitations of colour printing, please refer to product samples for colour matching. Product dimensions are for guidance only and may differ – please confirm details at time of ordering.



Accents 35mm – Contemporary Brackets

Antique Brass 35mm Complete Kits



Antique Brass/Slate Grey 35mm
FYNN Finial



Antique Brass/Chalk White 35mm
FYNN Finial



Antique Brass/Dark Oak 35mm
FYNN Finial



Antique Brass/Cotton Cream 35mm
FYNN Finial



Antique Brass/Coal Black 35mm
FYNN Finial



Antique Brass/Mid Oak 35mm
FYNN Finial



Antique Brass/Slate Grey 35mm
Plain Ball Finial



Antique Brass/Chalk White 35mm
Plain Ball Finial



Antique Brass/Dark Oak 35mm
Plain Ball Finial



Antique Brass/Cotton Cream 35mm
Plain Ball Finial



Antique Brass/Coal Black 35mm
Plain Ball Finial



Antique Brass/Mid Oak 35mm
Plain Ball Finial



Antique Brass/Slate Grey 35mm
Ribbed Ball Finial



Antique Brass/Chalk White 35mm
Ribbed Ball Finial



Antique Brass/Dark Oak 35mm
Ribbed Ball Finial



Antique Brass/Cotton Cream 35mm
Ribbed Ball Finial



Antique Brass/Coal Black 35mm
Ribbed Ball Finial



Antique Brass/Mid Oak 35mm
Ribbed Ball Finial

35mm Accents Complete Kit Sizes Available:

1.20m (3'11") 1.50m (4'11") 1.80m (5'11") 2.40m* (7'10")
3.00m* (9'10") 3.60m* (11'10") 4.80m* (15'9")

* Denotes 2 piece pole with joiner and includes extra bracket

Packed:

Individual



Transport Packed

Kit includes:



NOTE: 2.40 and 3.00m single length poles are available to special order and **must** be specified at point of order.

DISCLAIMER: Whilst every effort has been made to ensure colour accuracy, due to the limitations of colour printing, please refer to product samples for colour matching. Product dimensions are for guidance only and may differ – please confirm details at time of ordering.

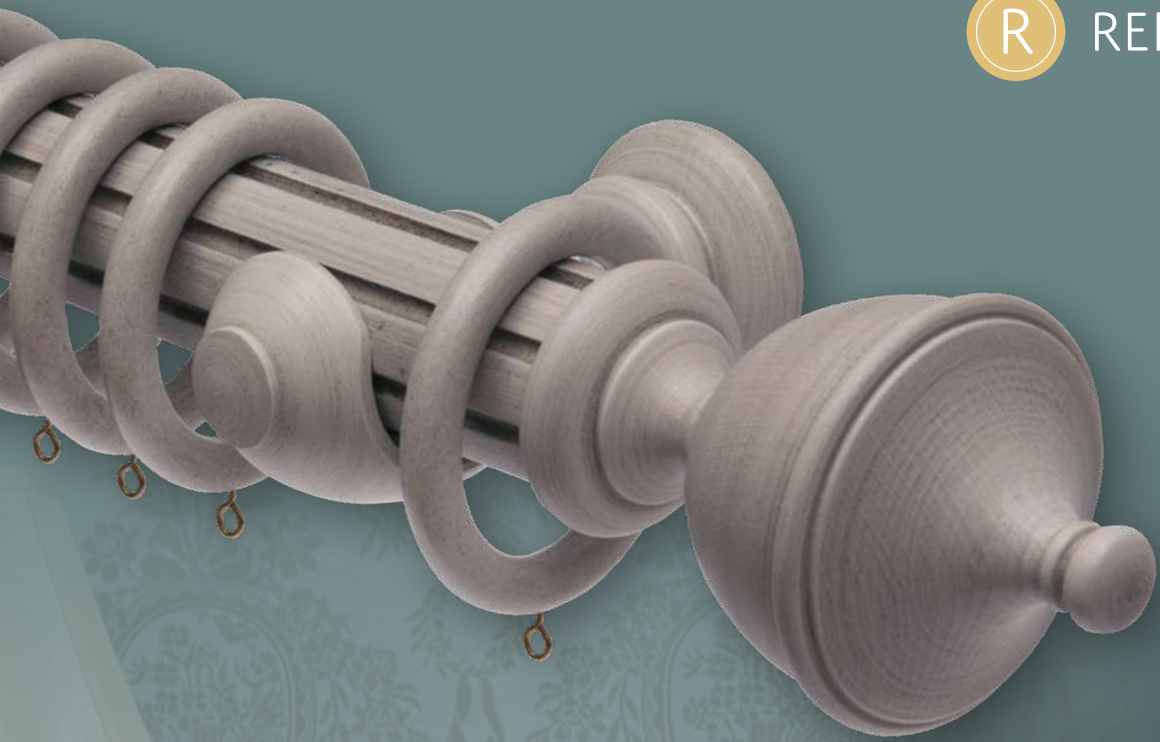

HANDFINISHED CURTAIN POLES

HANDFINISHED CURTAIN POLES



Duet Range

The Duet range offers three timeless finial designs in six hand-finished classical colours. Featuring a unique pole design – choose between the traditional smooth side, or with a simple twist, swap to reveal an elegant reeded side – the choice is yours.

50mm Swap Reversible Pole



Reeded side



Smooth side

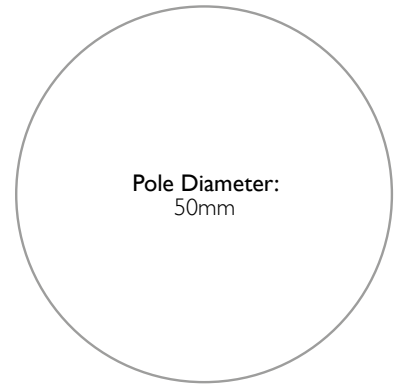
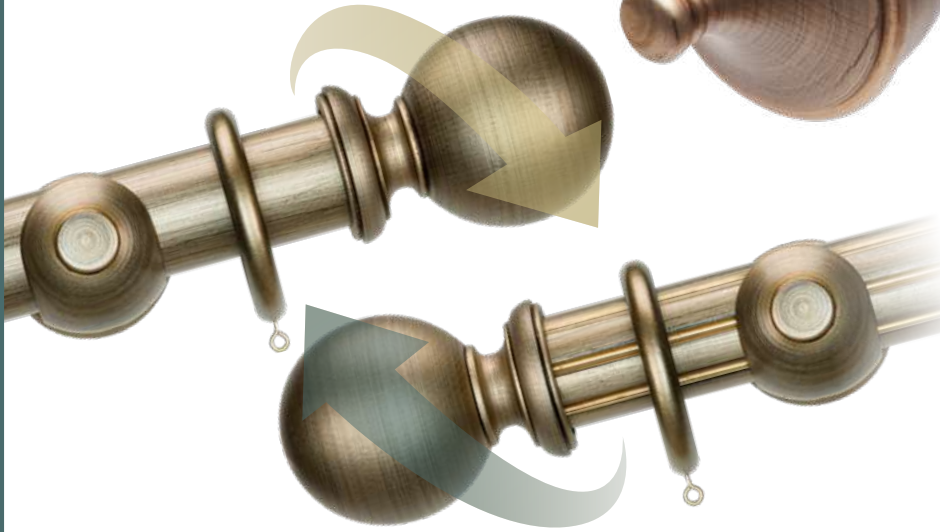

Pole Diameter:
50mm

Duet Range – Colour finishes:

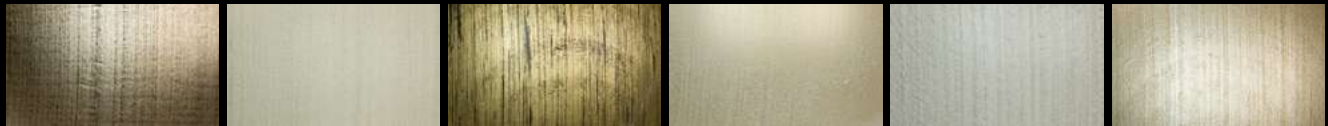

BYZANTINE BRONZE

TRAVERTINE

VENETIAN GOLD

BAROQUE CREAM

CHATEAU GREY

DUTCH SILVER

Kit Components

Cut-to-length service is also available – ask for details

Component	50mm Pole Kit Sizes				
	1.80m (5'11")	2.40m (7'10")	3.00m* (9'10")	3.60m* (11'10")	4.80m* (15'9")
Pole	1 x 1.80m	1 x 2.40m	2 x 1.50m	2 x 1.80m	2 x 2.40m
Brackets	2	3	3	3	3
Finials	2	2	2	2	2
Rings	18	24	30	36	48

* Denotes 2 piece pole with joiner and includes extra bracket. All kits include fittings.

NOTES:

- Poles in 180cm and 240cm sets are supplied in 1 piece with 2 wooden cup brackets.
- Poles in 300cm, 360cm and 480cm sets are supplied in 2 pieces with a joining screw and 3 wooden cup brackets.
- Poles sets include rings @10/m. Extra rings available in packs of 4.
- Brass or chrome brackets are available as an optional extra.
- Holdbacks are sold individually.



This curtain pole is suitable for medium-to-heavy weight curtains



Suitable for straight runs ONLY



Kits/components are delivered in transport packaging



Swap reversible poles – Reeded or Smooth option



Available in kit form for simple ordering



Poles available made-to-measure

DISCLAIMER: Whilst every effort has been made to ensure colour accuracy, due to the limitations of colour printing, please refer to product samples for colour matching. Product dimensions are for guidance only and may differ – please confirm details at time of ordering.

Duet 50mm Components

50mm Finials

Packed: Individually to be added to sets



50mm Rings

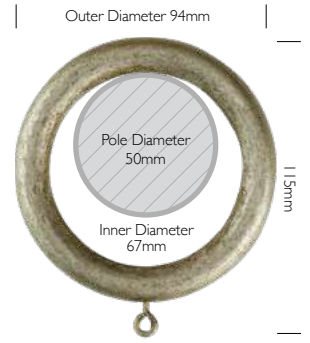

Packed: Individually or part of a set

Duet Brackets



Packed: Individually or part of a set

Packed: Individually

Packed: Individually

Matching Duet Holdbacks



Packed: Individually

Colour Sample & POS



Duet Colour Sample Swatch



Duet Display Block

All components and sets are available in all colours.

Duet Range – Colour finishes:



Duet 50mm Pole Sets – sizes available:

1.80m (5'11") | 2.40m (7'10") | 3.00m* (9'10")
3.60m* (11'10") | 4.80m* (15'9")

*Denotes 2 piece pole with joiner and includes extra bracket

Packed: Individually Transport Packed

Set includes:



**

Matching Eyelets:

See this Catalogue p206-210

Note: These poles are a natural wood hand-finished product, so some colour variations may occur.

**Order finials separately

DISCLAIMER: Whilst every effort has been made to ensure colour accuracy, due to the limitations of colour printing, please refer to product samples for colour matching. Product dimensions are for guidance only and may differ – please confirm details at time of ordering.

Duet 50mm – Pole Kits

Duet Byzantine Bronze 50mm Pole Kits**

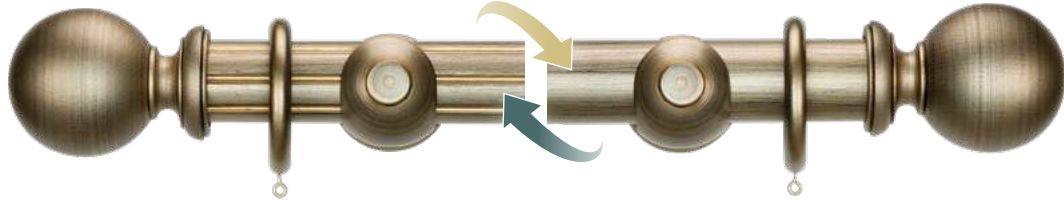

Ball – Reeded

Ball – Smooth

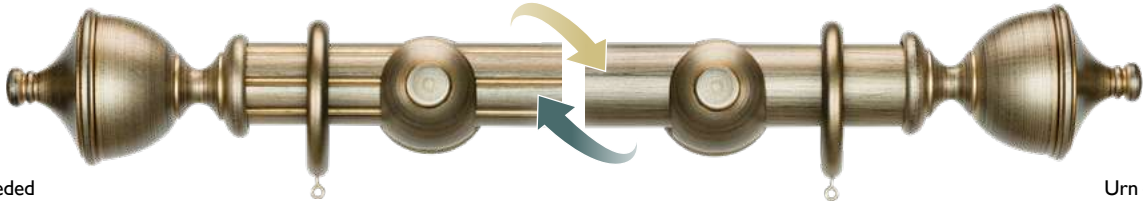

Urn – Reeded

Urn – Smooth

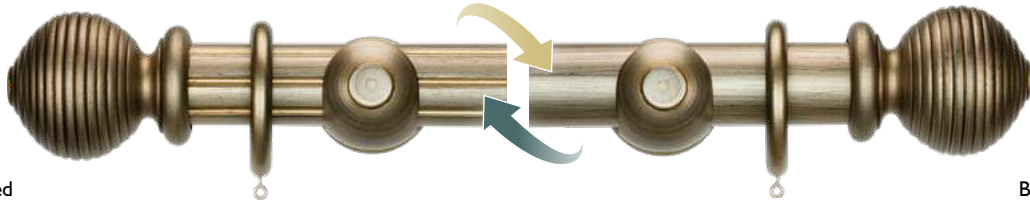

Beehive – Reeded

Beehive – Smooth

Duet 50mm Pole Sets – sizes available:

1.80m (5'11") 2.40m (7'10") 3.00m* (9'10")
 3.60m* (11'10") 4.80m* (15'9")

*Denotes 2 piece pole with joiner and includes extra bracket

Packed: Individually 
 Transport Packed

Set includes:



**

Matching Eyelets:

See this Catalogue p206–210



**Order finials separately

Duet Travertine 50mm Pole Kits**

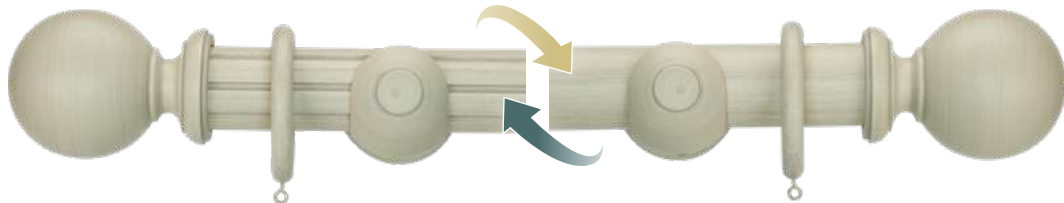

Ball – Reeded

Ball – Smooth

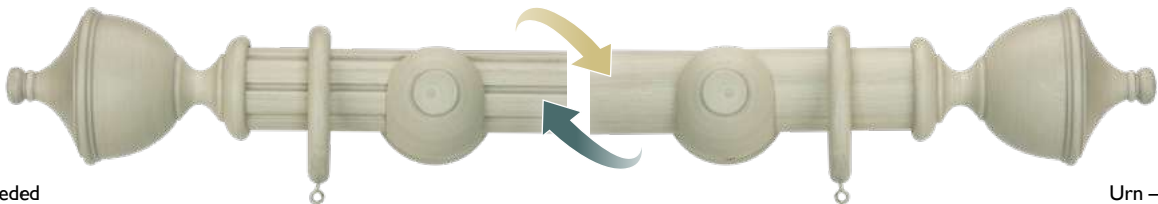

Urn – Reeded

Urn – Smooth

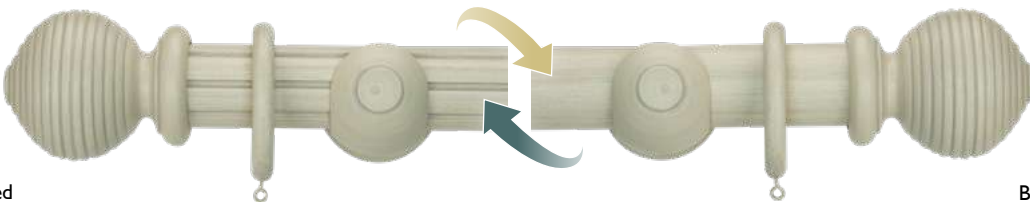

Beehive – Reeded

Beehive – Smooth

Duet 50mm Pole Sets – sizes available:

1.80m (5'11") 2.40m (7'10") 3.00m* (9'10")
 3.60m* (11'10") 4.80m* (15'9")

*Denotes 2 piece pole with joiner and includes extra bracket

Packed: Individually 
 Transport Packed

Set includes:



**

Matching Eyelets:

See this Catalogue p206–210



**Order finials separately

DISCLAIMER: Whilst every effort has been made to ensure colour accuracy, due to the limitations of colour printing, please refer to product samples for colour matching. Product dimensions are for guidance only and may differ – please confirm details at time of ordering.

Duet 50mm – Pole Kits

Duet Venetian Gold 50mm Pole Kits**

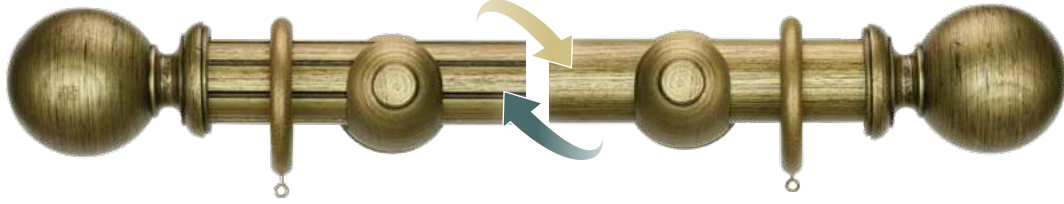

Ball – Reeded

Ball – Smooth

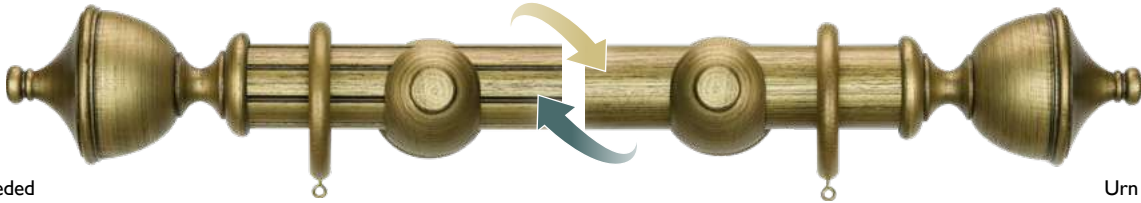

Urn – Reeded

Urn – Smooth

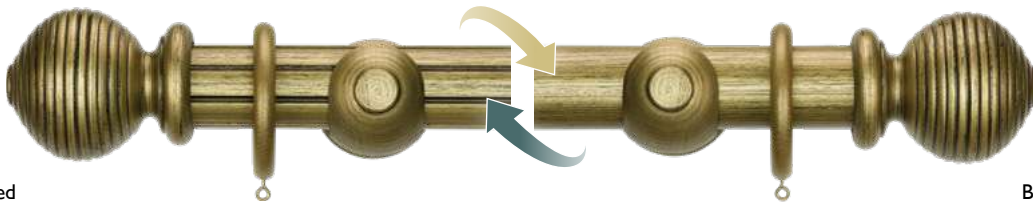

Beehive – Reeded

Beehive – Smooth

Duet 50mm Pole Sets – sizes available:

1.80m (5'11") 2.40m (7'10") 3.00m* (9'10")
 3.60m* (11'10") 4.80m* (15'9")

*Denotes 2 piece pole with joiner and includes extra bracket

Packed: Individually 
 Transport Packed

Set includes:



**

Matching Eyelets: See this Catalogue p206–210 

**Order finials separately

Duet Baroque Cream 50mm Pole Kits**

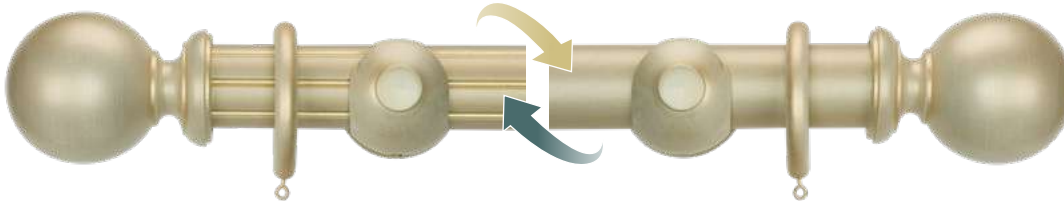

Ball – Reeded

Ball – Smooth

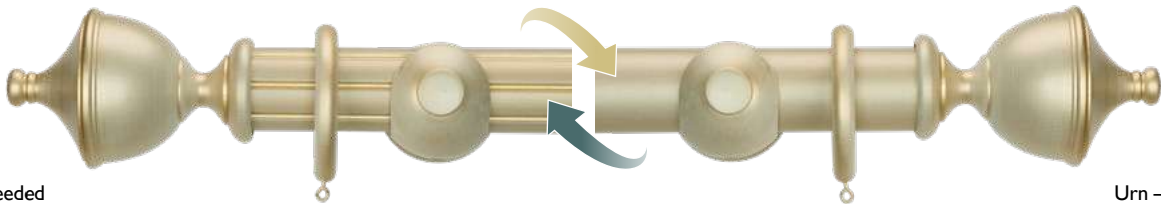

Urn – Reeded

Urn – Smooth

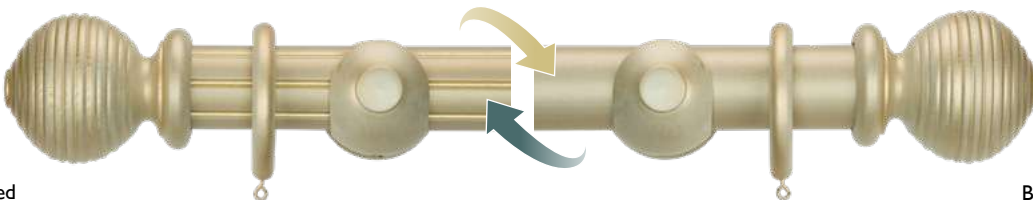

Beehive – Reeded

Beehive – Smooth

Duet 50mm Pole Sets – sizes available:

1.80m (5'11") 2.40m (7'10") 3.00m* (9'10")
 3.60m* (11'10") 4.80m* (15'9")

*Denotes 2 piece pole with joiner and includes extra bracket

Packed: Individually 
 Transport Packed

Set includes:



**

Matching Eyelets: See this Catalogue p206–210 

**Order finials separately

DISCLAIMER: Whilst every effort has been made to ensure colour accuracy, due to the limitations of colour printing, please refer to product samples for colour matching. Product dimensions are for guidance only and may differ – please confirm details at time of ordering.



RENAISSANCE

TEL 0113 250 4499

• EMAIL SALES@RCA-UK.COM

• VISIT RCA-UK.COM

Duet 50mm – Pole Kits

Duet Chateau Grey 50mm Pole Kits**

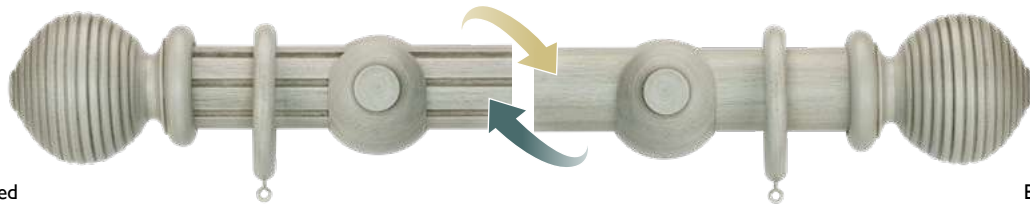
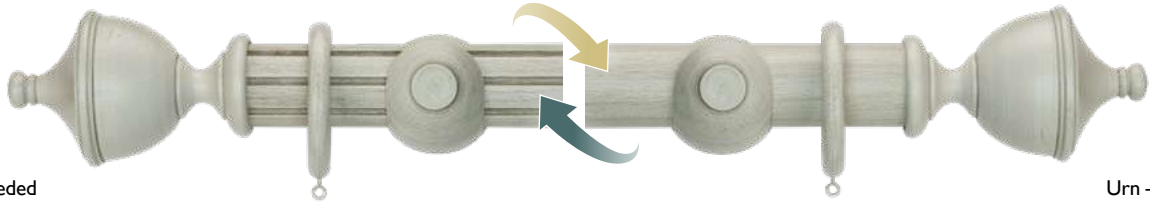
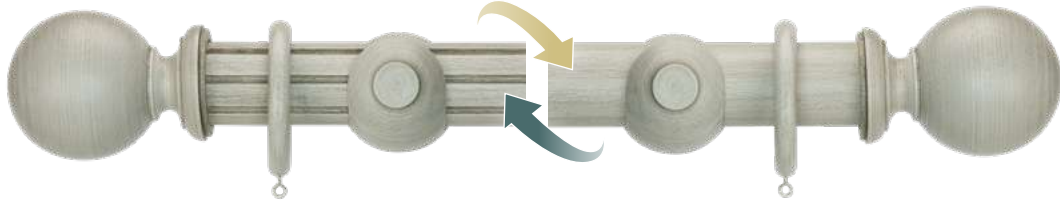

Duet 50mm Pole Sets – sizes available:

1.80m (5'11") 2.40m (7'10") 3.00m* (9'10")
 3.60m* (11'10") 4.80m* (15'9")

*Denotes 2 piece pole with joiner and includes extra bracket

Packed: Individually 
 Transport Packed

Set includes:



**

Matching Eyelets:

See this Catalogue p206–210



**Order finials separately

Dutch Silver 50mm Pole Kits**

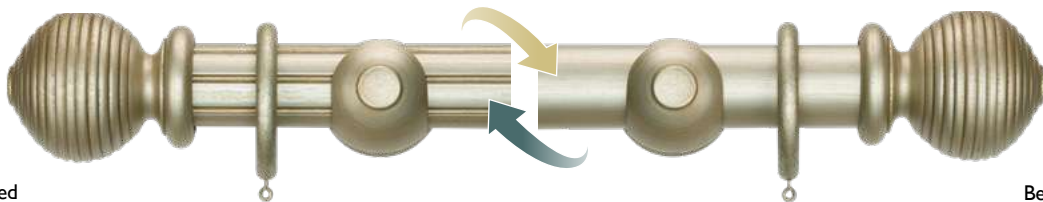
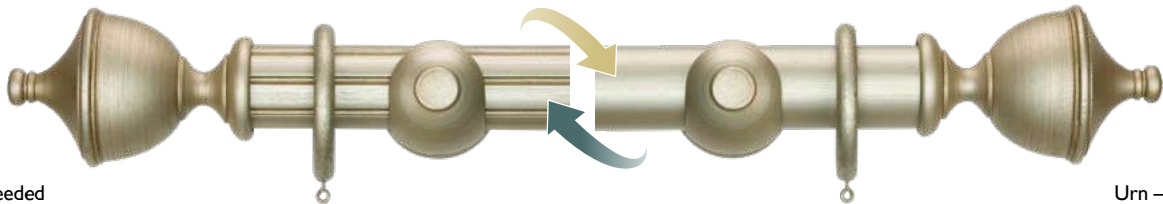
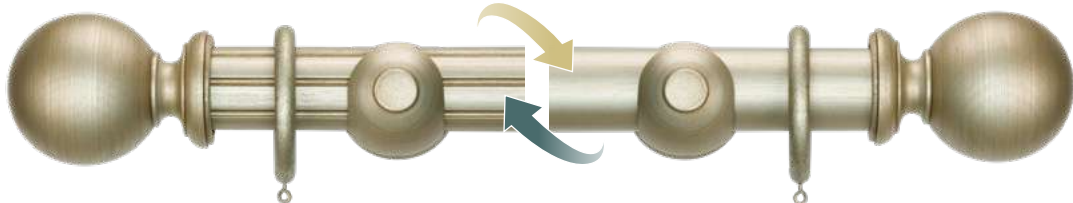

Duet 50mm Pole Sets – sizes available:

1.80m (5'11") 2.40m (7'10") 3.00m* (9'10")
 3.60m* (11'10") 4.80m* (15'9")

*Denotes 2 piece pole with joiner and includes extra bracket

Packed: Individually 
 Transport Packed

Set includes:



**

Matching Eyelets:

See this Catalogue p206–210



**Order finials separately

DISCLAIMER: Whilst every effort has been made to ensure colour accuracy, due to the limitations of colour printing, please refer to product samples for colour matching. Product dimensions are for guidance only and may differ – please confirm details at time of ordering.



RENAISSANCE

WOODEN CURTAIN POLES

WOODEN CURTAIN POLES



RENAISSANCE

TEL 0113 250 4499



EMAIL SALES@RCA-UK.COM



VISIT RCA-UK.COM

Natur Oaks

Sustainable Wooden Poles

Made from 100% accredited wood the Natur range is our most sustainable Curtain Pole yet. Inspired by the ancient forests of Earth, Natur Oaks is available in 3 striking shades with a subtle woodgrain effect surface and a soft natural sheen finish. A classical ball-end finial design with elegant cup brackets – in a choice of 35mm or 50mm poles.



35mm Ball Finial



Also Available:
Matching Holdbacks

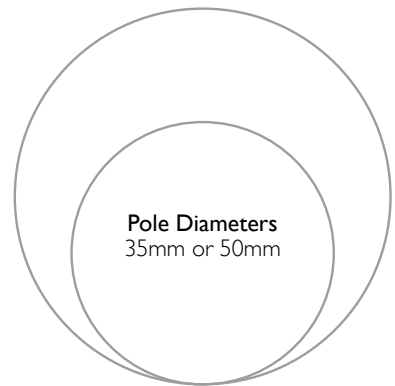

Pole Diameters
35mm or 50mm



50mm Ball Finial

Colour finishes:

DARK OAK

MID OAK

LIGHT OAK

For Eyelets
see this
Catalogue
p206–210



Natur Oaks Kit Components

Component	35 and 50mm Pole Kit Sizes									50mm only
	1.20m (3'11")	1.50m (4'11")	1.80m (5'11")	2.00m (6'9")	2.40m (7'10")	3.00m* (9'10")	3.60m* (11'10")	4.00m* (13'1")	4.80m* (15'9")	6.00m*‡ (19'10")
Pole	1 x 1.20m	1 x 1.50m	1 x 1.80m	1 x 2.00m	1 x 2.40m	2 x 1.50m	2 x 1.80m	2 x 2.00m	2 x 2.40m	2 x 3.00m
Brackets	2	2	2	2	3	3	3	3	3	3
Finials	2	2	2	2	2	2	2	2	2	2
Rings	12	16	18	20	24	30	36	40	48	60

* Denotes 2 piece pole with joiner and includes extra bracket. All kits include fittings.

‡ 6.00m Pole Kit Set is available in 50mm only



This curtain pole is suitable for medium-to-heavy weight curtains



Suitable for straight runs ONLY



Kits/components are delivered in transport packaging



Available in contract components for large jobs



Available in kit form for simple ordering



Poles available made-to-measure

DISCLAIMER: Whilst every effort has been made to ensure colour accuracy, due to the limitations of colour printing, please refer to product samples for colour matching. Product dimensions are for guidance only and may differ – please confirm details at time of ordering.

Natur Oaks – 35mm Components & Pole Sets

35mm Components

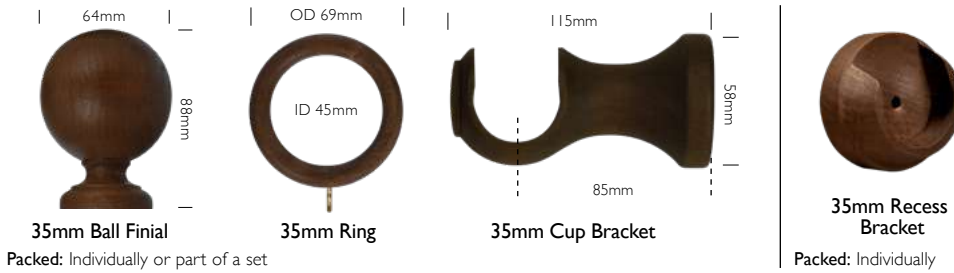

35mm Pole Lengths



Available Lengths:
120cm, 150cm, 180cm,
200cm, 240cm, 300cm

Packed: Individually or part of a set

Natur Oaks 35mm – Complete Kits



Light Oak 35mm



Mid Oak 35mm



Dark Oak 35mm

Packed:
Individually

Natur Oaks 35mm Complete Kit Sizes Available:

1.20m (3'11") 1.50m (4'11") 1.80m (5'11") 2.00m (6'9") 2.40m (7'10")
3.00m* (9'10") 3.60m* (11'10") 4.00m* (13'1") 4.80m* (15'9")

* Denotes 2 piece pole with joiner and includes an extra bracket.



Transport Packed

Kit includes:



Natur Oaks – 50mm Components & Pole Sets

50mm Components

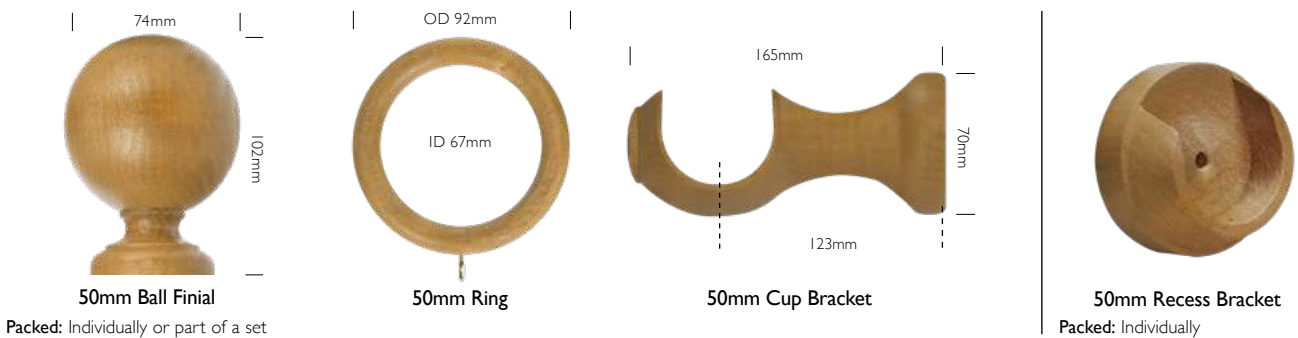

Natur Holdbacks



Packed: Individually

50mm Pole Lengths



Available Lengths:
120cm, 150cm, 180cm,
200cm, 240cm, 300cm

Packed: Individually or part of a set

Natur POS & Samples

Natur Desktop Colour Display
Code: 80N5DESKDY

Natur 50mm Colour Stick
Code: 80N5COLSTK

Natur Ring Sample Set
Code: 80N5RISAMP

See page
37 for full
details

Natur Oaks 50mm – Complete Kits



Light Oak 50mm



Mid Oak 50mm



Dark Oak 50mm

Packed:
Individually

Natur Oaks 50mm Complete Kit Sizes Available:

1.20m (3'11") 1.50m (4'11") 1.80m (5'11") 2.00m (6'9") 2.40m (7'10")
3.00m* (9'10") 3.60m* (11'10") 4.00m* (13'1") 4.80m* (15'9") 6.00m* (19'10")

* Denotes 2 piece pole with joiner and includes an extra bracket.



Transport Packed

Kit includes:



DISCLAIMER: Whilst every effort has been made to ensure colour accuracy, due to the limitations of colour printing, please refer to product samples for colour matching. Product dimensions are for guidance only and may differ – please confirm details at time of ordering.



RENAISSANCE

TEL 0113 250 4499

• EMAIL SALES@RCA-UK.COM

• VISIT RCA-UK.COM

35

Natur Shades

Sustainable Wooden Poles

Made from 100% accredited wood the Natur range is our most sustainable Curtain Pole yet. Inspired by the natural elements of Earth, Natur Shades is available in a stunning range of chalky/Matt paint finishes to compliment today's modern interiors perfectly. A classical ball-end finial design with elegant cup brackets – in a choice of 35mm or 50mm poles.

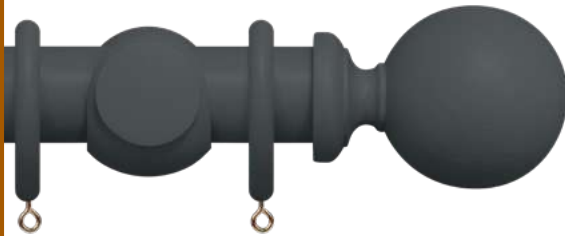
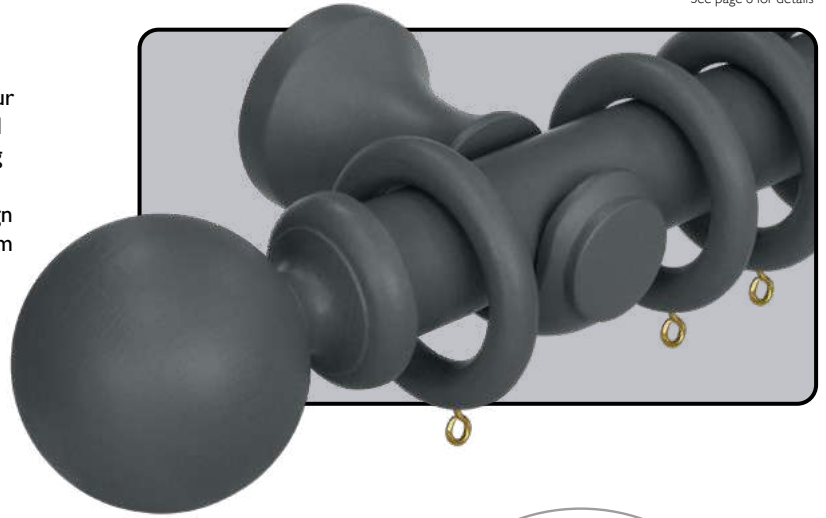

35mm Ball Finial



Also Available:
Matching Holdbacks

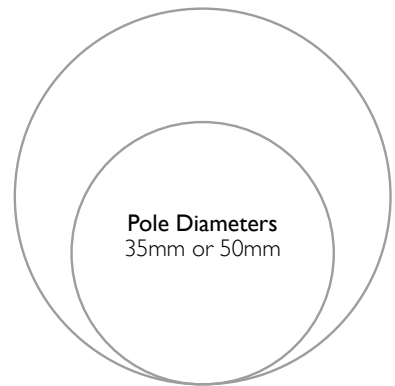

Pole Diameters
35mm or 50mm



50mm Ball Finial

Colour finishes:

CHALK WHITE

COTTON CREAM

LIGHT GREY

SLATE GREY

STONE GREY

CHARCOAL BLACK

Natur Shades Kit Components

Component	35 and 50mm Pole Kit Sizes									50mm only
	1.20m (3'11")	1.50m (4'11")	1.80m (5'11")	2.00m (6'9")	2.40m (7'10")	3.00m* (9'10")	3.60m* (11'10")	4.00m* (13'1")	4.80m* (15'9")	6.00m*‡ (19'10")
Pole	1 x 1.20m	1 x 1.50m	1 x 1.80m	1 x 2.00m	1 x 2.40m	2 x 1.50m	2 x 1.80m	2 x 2.00m	2 x 2.40m	2 x 3.00m
Brackets	2	2	2	2	3	3	3	3	3	3
Finials	2	2	2	2	2	2	2	2	2	2
Rings	12	16	18	20	24	30	36	40	48	60

* Denotes 2 piece pole with joiner and includes extra bracket. All kits include fittings.

‡ 6.00m Pole Kit Set is available in 50mm only



This curtain pole is suitable for medium-to-heavy weight curtains



Suitable for straight runs ONLY



Kits/components are delivered in transport packaging



Available in contract components for large jobs



Available in kit form for simple ordering



Poles available made-to-measure

DISCLAIMER: Whilst every effort has been made to ensure colour accuracy, due to the limitations of colour printing, please refer to product samples for colour matching. Product dimensions are for guidance only and may differ – please confirm details at time of ordering.

Natur Shades – 35mm Components & Pole Sets

35mm Components

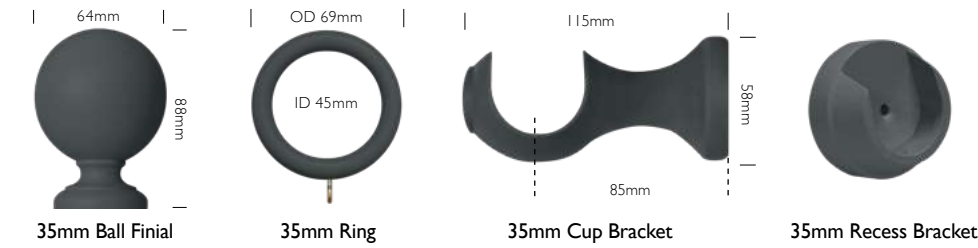

Packed: Individually or part of a set

35mm Pole Lengths



Available Lengths:
120cm, 150cm, 180cm,
200cm, 240cm, 300cm

Packed: Individually or part of a set

Natur Holdbacks

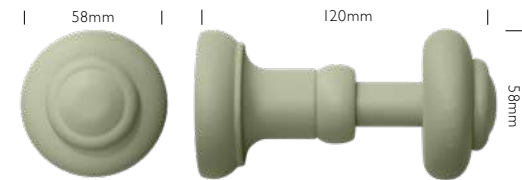

Packed: Individually

Natur POS & Samples



Natur Desktop Colour Display
Code: 80N5DESKDY

Natur 50mm Colour Stick
Code: 80N5COLSTK

Natur Ring Sample Set
Code: 80N5RISAMP

Ball End Hooks



NEW Dark Grey

NEW Light Grey

NEW Cream

White

Black

new
3 new colours to
compliment Natur
Shades Range

Hook Dimensions

Projection: 40mm
Screw Length: 30mm
Height: 35mm



Natur Shades 35mm – Complete Kits



Chalk White 35mm



Light Grey 35mm



Slate Grey 35mm



Stone Grey 35mm

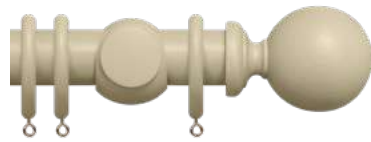

Cotton Cream 35mm



Charcoal Black 35mm

Packed: Individually

Natur Shades 35mm Complete Kit Sizes Available:

1.20m (3'11") 1.50m (4'11") 1.80m (5'11") 2.00m (6'9") 2.40m (7'10")
3.00m* (9'10") 3.60m* (11'10") 4.00m* (13'1") 4.80m* (15'9")

* Denotes 2 piece pole with joiner and includes an extra bracket.



Transport Packed

Kit includes:



DISCLAIMER: Whilst every effort has been made to ensure colour accuracy, due to the limitations of colour printing, please refer to product samples for colour matching. Product dimensions are for guidance only and may differ – please confirm details at time of ordering.

Natur Shades – 50mm Components & Pole Sets

50mm Components



50mm Ball Finial



50mm Ring

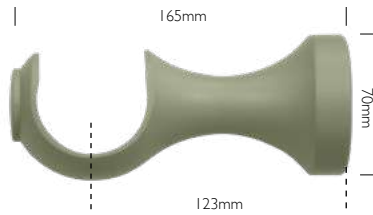

50mm Cup Bracket



50mm Recess Bracket

Packed: Individually or part of a set

Packed: Individually

Ball End Hooks



NEW Dark Grey

new
3 new colours to
complement Natur
Shades Range



NEW Light Grey



NEW Cream



White



Black

Hook Dimensions
Projection: 40mm
Screw Length: 30mm
Height: 35mm



Natur Holdbacks



Packed: Individually

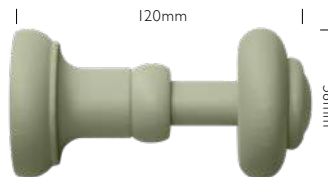

50mm Pole Lengths



Available Lengths:
120cm, 150cm, 180cm,
200cm, 240cm, 300cm

Packed: Individually or part of a set

Nature POS & Samples



Natur Desktop Colour Display

Code: 80N5DESKDY

Natur 50mm Colour Stick

Code: 80N5COLSTK

Natur Ring Sample Set

Code: 80N5RISAMP

See page
37 for full
details

Natur Shades 50mm – Complete Kits



Chalk White 50mm

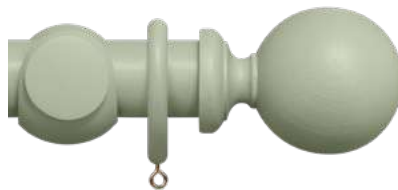

Light Grey 50mm



Slate Grey 50mm

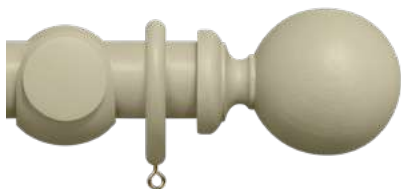

Stone Grey 50mm

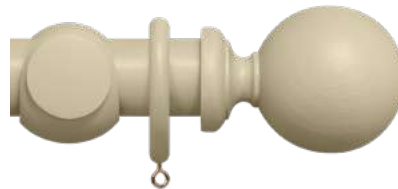

Cotton Cream 50mm



Charcoal Black 50mm

Packed: Individually

Natur Oaks 50mm Complete Kit Sizes Available:

1.20m (3'11") 1.50m (4'11") 1.80m (5'11") 2.00m (6'9") 2.40m (7'10")
3.00m* (9'10") 3.60m* (11'10") 4.00m* (13'1") 4.80m* (15'9") 6.00m* (19'10")

* Denotes 2 piece
pole with joiner
and includes an
extra bracket.



Transport Packed

Kit includes:



DISCLAIMER: Whilst every effort has been made to ensure colour accuracy, due to the limitations of colour printing, please refer to product samples for colour matching. Product dimensions are for guidance only and may differ – please confirm details at time of ordering.



Coming Soon
28mm Diameter Poles

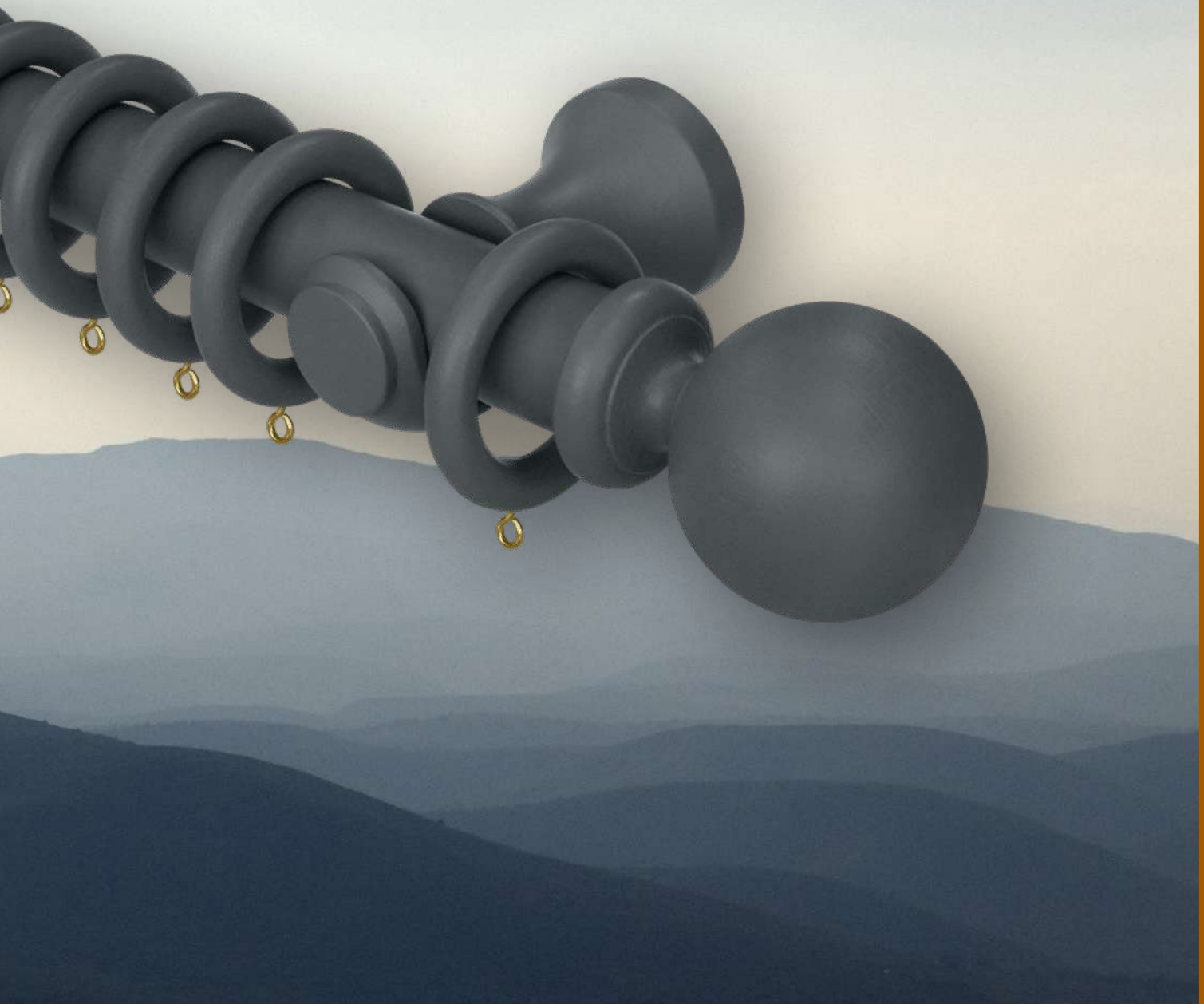

WOODEN CURTAIN POLES

Draw Rods

Metal Draw Rods



Contemporary Steel Draw Rod

Sizes: 100cm, 125cm, 150cm, 200cm[†]

[†]200cm is a special order product and may have a longer lead time
 *Titanium Draw Rods coordinate very well with all Brushed Nickel & Stainless Steel Pole Kits.

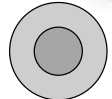

14mm Handle | 7mm Body



Plastic Coated Steel Draw Rod

Sizes: 50cm, 75cm, 100cm, 125cm, 150cm



10mm Handle | 5mm Body



Style Aluminium Draw Rod

Sizes: 75cm, 100cm, 125cm, 150cm

Handle Detail



9mm Hollow Rod

Plastic Draw Rods



Luxury Clear Acrylic Draw Rod

Sizes: 75cm, 100cm, 125cm, 150cm, 200cm

Clip Detail



12mm Rod



Clear Acrylic Draw Rod with Steel Core Sizes: 75cm, 100cm, 125cm, 150cm

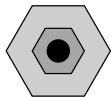

15mm Handle | 8mm Body

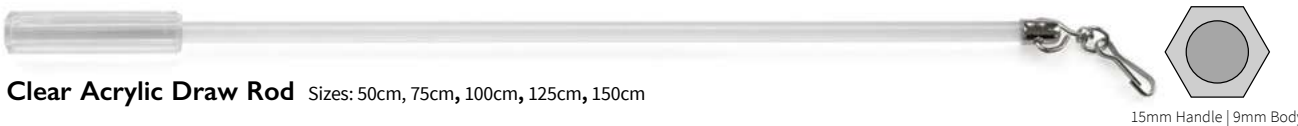

Clear Acrylic Draw Rod Sizes: 50cm, 75cm, 100cm, 125cm, 150cm

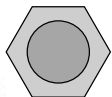

15mm Handle | 9mm Body

DISCLAIMER: Whilst every effort has been made to ensure colour accuracy, due to the limitations of colour printing, please refer to product samples for colour matching. Product dimensions are for guidance only and may differ – please confirm details at time of ordering.

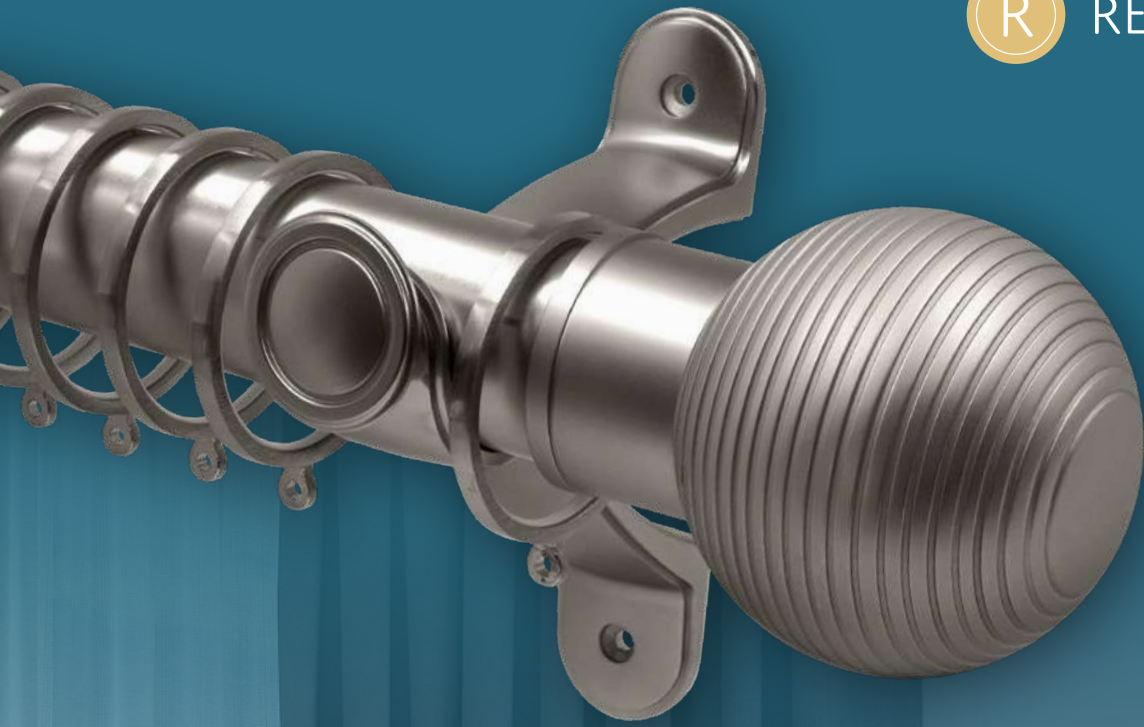

METAL CURTAIN POLES



METAL CURTAIN POLES

Spectrum Range

Our premium range of larger 50mm and 35mm diameter metal curtain poles. Spectrum is a high quality bespoke designer selection of poles in antique brass, polished silver, titanium and black nickel luxury finishes, where a statement or a compliment to enhance curtains is required.

The Spectrum range may be specified as complete kits, or purchased as individual components for either eyelet or traditional curtain poles. Accessories may be used in conjunction with other combinations of wood and metal, or to enhance pole track systems such as Metropole in order to achieve specifically desired design outcomes or functions.

NEW Ribbed Ball Finial now available for both 50mm and 35mm in all four colours options

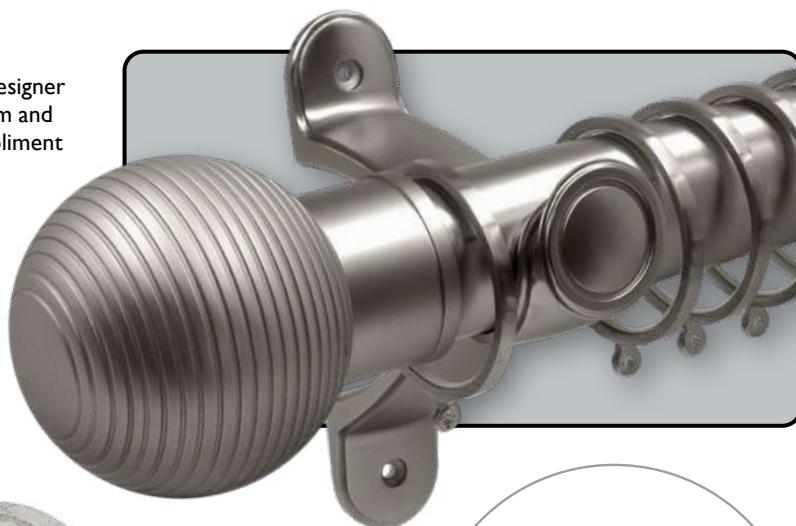

35mm Complete Kit with Pumpkin Finial



50mm Pole Kit with Studded Ball Finial

Colour finishes available:

- BLACK NICKEL
- ANTIQUÉ BRASS
- POLISHED SILVER
- TITANIUM

Refer to the following pages to confirm finial colour availability.

Kit Components

Single length poles available up to 3.00m on request

Components	Pole Kit Sizes							
	1.20m (3'11")	1.50m (4'11")	1.80m (5'11")	2.40m* (7'10")	3.00m* (9'10")	3.60m* (11'10")	4.80m*(15'9")	6.00m* (19'8")
Pole	1 x 1.20m	1 x 1.50m	1 x 1.80m	1 x 2.40m	2 x 1.50m	2 x 1.80m	2 x 2.40m	2 x 3.00m
End Brackets	2	2	2	2	2	2	2	2
Centre Brackets	-	-	-	1	1	1	1	1
Finials	2	2	2	2	2	2	2	2
Rings	12	16	18	24	30	36	48	60

Complete Pole Kits available ensuring your purchase is quick, simple and hassle free. All kits include fittings and instructions.

* Denotes 2 piece pole with joiner and includes centre bracket. **NOTE:** 3m single length poles are available to special order and **must** be specified at point of order.



This curtain pole is suitable for medium-to-heavy weight curtains



Suitable for straight runs ONLY



Kits/components are delivered in transport packaging



Available in contract components for large jobs



Available in kit form for simple ordering



Poles available made-to-measure

DISCLAIMER: Whilst every effort has been made to ensure colour accuracy, due to the limitations of colour printing, please refer to product samples for colour matching. Product dimensions are for guidance only and may differ – please confirm details at time of ordering.

Spectrum

Finials



FYNN
Black Nickel



Crystal Diamond
Black Nickel



Glass Pumpkin
Black Nickel



Plain Ball
Black Nickel



Green Mosaic Ball
Black Nickel



Rose Mosaic Ball
Black Nickel



Studded Ball
Black Nickel



Smoked Crystal Beads
Black Nickel



NEW Ribbed Ball
Black Nickel



FYNN
Polished Silver



Crystal Diamond
Polished Silver



Crackled Glass Ball
Polished Silver



Clear Crystal Beads
Polished Silver



Plain Ball
Polished Silver



Mirror Mosaic Ball
Polished Silver



Studded Ball
Polished Silver



NEW Ribbed Ball
Polished Silver



FYNN
Antique Brass



Flat Dimple Ball
Antique Brass



Glass Pumpkin
Antique Brass



Plain Ball
Antique Brass



NEW Ribbed Ball
Antique Brass



Long Cage
Antique Brass



FYNN
Titanium



Crystal Diamond
Titanium



Crackled Glass Ball
Titanium



Plain Ball
Titanium



Clear Crystal Beads
Titanium



Flat Dimple Ball
Titanium



Green Mosaic Ball
Titanium



Rose Mosaic Ball
Titanium – 35mm ONLY



NEW Ribbed Ball
Titanium



BLACK NICKEL

ANTIQUE BRASS

POLISHED SILVER

TITANIUM

DISCLAIMER: Whilst every effort has been made to ensure colour accuracy, due to the limitations of colour printing, please refer to product samples for colour matching. Product dimensions are for guidance only and may differ – please confirm details at time of ordering.

Spectrum – 50mm Components

50mm Finials

 <p>85mm 120mm</p> <p>Clear Cut Crystal Diamond</p> <p>Color swatches: Black, Silver, Gold, Grey</p>	 <p>96mm 130mm</p> <p>Crackled Glass Ball</p> <p>Color swatches: Silver, Gold, Grey</p>	 <p>106mm 141mm</p> <p>Clear Crystal Beads</p> <p>Color swatches: Silver, Gold, Grey</p>	 <p>106mm 141mm</p> <p>Smoked Crystal Beads</p> <p>Color swatches: Black, Silver, Gold, Grey</p>	 <p>99mm 134mm</p> <p>Flat Dimple Ball</p> <p>Color swatches: Silver, Gold, Grey</p>	 <p>98mm 132mm</p> <p>Glass Pumpkin</p> <p>Color swatches: Black, Gold, Silver, Grey</p>	 <p>89mm 261mm</p> <p>Long Cage</p> <p>Color swatches: Silver, Gold, Grey</p>
 <p>106mm 141mm</p> <p>Green Mosaic Ball</p> <p>Color swatches: Black, Silver, Gold, Grey</p>	 <p>106mm 141mm</p> <p>Mirror Mosaic Ball</p> <p>Color swatches: Silver, Gold, Grey</p>	 <p>106mm 141mm</p> <p>Rose Mosaic Ball</p> <p>Color swatches: Black, Silver, Gold, Grey</p>	 <p>103mm 138mm</p> <p>Studded Ball</p> <p>Color swatches: Black, Silver, Gold, Grey</p>	 <p>100mm 139mm</p> <p>Plain Ball</p> <p>Color swatches: Black, Silver, Gold, Grey</p>	 <p>100mm 139mm</p> <p>NEW Ribbed Ball</p> <p>Color swatches: Black, Silver, Gold, Grey</p>	

Packed: Individually or part of a complete kit

50mm Poles

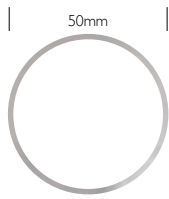

Single Length Poles



Sizes: 1.20m, 1.60m, 2.00m, 2.40m, 3.00m

Packed: Individually or part of a complete kit

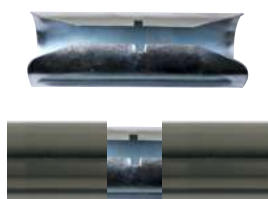

Pole Joiner

Packed: Individually

66mm Eyelets



Matching Eyelets Are Available

Please see Catalogue pages 210–214 for Eyelet options



Eyelet Poles

Available In All Styles

50mm Brackets

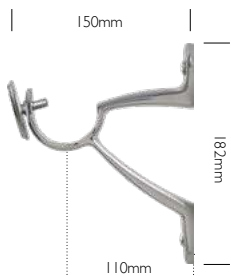

Luxury End Bracket



Packed: Individually or part of a complete kit



Luxury Centre Bracket

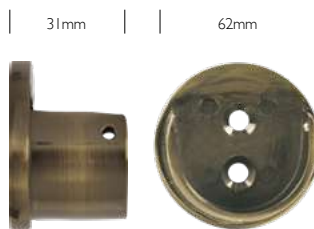

Recess Bracket



Packed: Individually

50mm Rings

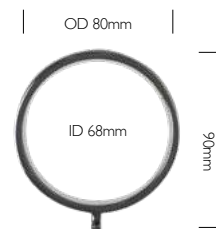

Rings Include Nylon Inserts To Ensure Quieter Running



Packed: Individually or part of a complete kit

BLACK NICKEL

ANTIQUE BRASS

POLISHED SILVER

TITANIUM

DISCLAIMER: Whilst every effort has been made to ensure colour accuracy, due to the limitations of colour printing, please refer to product samples for colour matching. Product dimensions are for guidance only and may differ – please confirm details at time of ordering.

Spectrum – 35mm Components

35mm Finials

<p>75mm</p>  <p>95mm</p> <p>Clear Cut Crystal Diamond</p> <p>☐ ☐ ☐ ☐</p>	<p>70mm</p>  <p>95mm</p> <p>Cracked Glass Ball</p> <p>☐ ☐ ☐ ☐</p>	<p>90mm</p>  <p>120mm</p> <p>Clear Crystal Beads</p> <p>☐ ☐ ☐ ☐</p>	<p>90mm</p>  <p>123mm</p> <p>Smoked Crystal Beads</p> <p>☐ ☐ ☐ ☐</p>	<p>88mm</p>  <p>130mm</p> <p>Flat Dimple Ball</p> <p>☐ ☐ ☐ ☐</p>	<p>81mm</p>  <p>112mm</p> <p>Glass Pumpkin</p> <p>☐ ☐ ☐ ☐</p>	<p>80mm</p>  <p>194mm</p> <p>Long Cage</p> <p>☐ ☐ ☐ ☐</p>
<p>81mm</p>  <p>114mm</p> <p>Green Mosaic Ball</p> <p>☐ ☐ ☐ ☐</p>	<p>81mm</p>  <p>114mm</p> <p>Mirror Mosaic Ball</p> <p>☐ ☐ ☐ ☐</p>	<p>81mm</p>  <p>114mm</p> <p>Rose Mosaic Ball</p> <p>☐ ☐ ☐ ☐</p>	<p>93mm</p>  <p>124mm</p> <p>Studded Ball</p> <p>☐ ☐ ☐ ☐</p>	<p>65mm</p>  <p>100mm</p> <p>Plain Ball</p> <p>☐ ☐ ☐ ☐</p>	<p>88mm</p>  <p>105mm</p> <p>NEW Ribbed Ball</p> <p>☐ ☐ ☐ ☐</p>	

Packed: Individually or part of a complete kit

35mm Poles

35mm



Single Length Poles

☐ ☐ ☐ ☐

Sizes: 1.20m, 1.60m, 2.00m, 2.40m, 3.00m

Packed: Individually or part of a complete kit

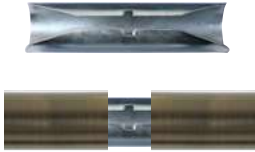

Pole Joiner

Packed: Individually

50mm Eyelets

OD 77mm



ID 50mm

Matching Eyelets Are Available

Please see Catalogue pages 210–214 for Eyelet options



Eyelet Poles

Available In All Styles

35mm Brackets

107mm

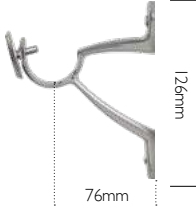

126mm

76mm

Luxury End Bracket

☐ ☐ ☐ ☐

Packed: Individually or part of a complete kit

107mm



42mm

76mm

Luxury Centre Bracket

☐ ☐ ☐ ☐

31mm



47mm



Recess Bracket

☐ ☐ ☐ ☐

Packed: Individually

35mm Rings

OD 60mm



ID 50mm

70mm

Rings Include Nylon Inserts

To Ensure Quieter Running

☐ ☐ ☐ ☐

Packed: Individually or part of a complete kit

BLACK NICKEL

ANTIQUE BRASS

POLISHED SILVER

TITANIUM

DISCLAIMER: Whilst every effort has been made to ensure colour accuracy, due to the limitations of colour printing, please refer to product samples for colour matching. Product dimensions are for guidance only and may differ – please confirm details at time of ordering.

Spectrum 50mm – Black Nickel Pole Kits

Black Nickel 50mm Complete kits



Plain Ball – Black Nickel 50mm



Smoked Crystal Beads – Black Nickel 50mm



Glass Pumpkin – Black Nickel 50mm



NEW Ribbed Ball – Black Nickel 50mm



Green Mosaic Ball – Black Nickel 50mm



Rose Mosaic Ball – Black Nickel 50mm



Studded Ball – Black Nickel 50mm



Crystal Cut Diamond – Black Nickel 50mm



FYNN – Black Nickel 50mm

50mm Spectrum Complete Kit Sizes Available:

1.20m (3'11") 1.50m (4'11") 1.80m (5'11") 2.40m (7'10")
3.00m* (9'10") 3.60m* (11'10") 4.80m* (15'9") 6.00m* (19'8")

* Denotes 2 piece pole with joiner and includes extra bracket

Packed:
Individual



Transport Packed

Kit includes:



NOTE: All Spectrum Kits are available as Eyelet Pole Kits – please see our Trade Price List for codes. Pole Kits are supplied without finials. Add the finials of your choice to Pole Kit code.

Spectrum 35mm – Black Nickel Pole Kits

Black Nickel 35mm Complete Kits



Plain Ball – Black Nickel 35mm



Smoked Crystal Beads – Black Nickel 35mm



Glass Pumpkin – Black Nickel 35mm



NEW Ribbed Ball – Black Nickel 35mm



Green Mosaic Ball – Black Nickel 35mm



Rose Mosaic Ball – Black Nickel 35mm



Studded Ball – Black Nickel 35mm



Crystal Cut Diamond – Black Nickel 35mm



FYNN – Black Nickel 35mm

35mm Spectrum Complete Kit Sizes Available:

1.20m (3'11") 1.50m (4'11") 1.80m (5'11") 2.40m (7'10")
3.00m* (9'10") 3.60m* (11'10") 4.80m* (15'9") 6.00m* (19'8")

* Denotes 2 piece pole with joiner and includes extra bracket

Packed:
Individual



Transport Packed

Kit includes:



NOTE: All Spectrum Kits are available as Eyelet Pole Kits – please see our Trade Price List for codes. Pole Kits are supplied without finials. Add the finials of your choice to Pole Kit code.

DISCLAIMER: Whilst every effort has been made to ensure colour accuracy, due to the limitations of colour printing, please refer to product samples for colour matching. Product dimensions are for guidance only and may differ – please confirm details at time of ordering.

Spectrum 50mm – Antique Brass Pole Kits

Antique Brass 50mm Complete Kits



Plain Ball – Antique Brass 50mm



Flat Dimple Ball – Antique Brass 50mm



Glass Pumpkin – Antique Brass 50mm



NEW Ribbed Ball – Antique Brass 50mm



Long Cage – Antique Brass 50mm



FYNN – Antique Brass 50mm

50mm Spectrum Complete Kit Sizes Available:

1.20m (3'11") 1.50m (4'11") 1.80m (5'11") 2.40m (7'10")
3.00m* (9'10") 3.60m* (11'10") 4.80m* (15'9") 6.00m* (19'8")

* Denotes 2 piece pole with joiner and includes extra bracket

Packed:

Individual



Transport Packed

Kit includes:



NOTE: All Spectrum Kits are available as Eyelet Pole Kits – please see our Trade Price List for codes. Pole Kits are supplied without finials. Add the finials of your choice to Pole Kit code.

Spectrum 35mm – Antique Brass Pole Kits

Antique Brass 35mm Complete Kits



Plain Ball – Antique Brass 35mm



Flat Dimple Ball – Antique Brass 35mm



Glass Pumpkin – Antique Brass 35mm



NEW Ribbed Ball – Antique Brass 35mm



Long Cage – Antique Brass 35mm



FYNN – Antique Brass 35mm

35mm Spectrum Complete Kit Sizes Available:

1.20m (3'11") 1.50m (4'11") 1.80m (5'11") 2.40m (7'10")
3.00m* (9'10") 3.60m* (11'10") 4.80m* (15'9") 6.00m* (19'8")

* Denotes 2 piece pole with joiner and includes extra bracket

Packed:

Individual



Transport Packed

Kit includes:



NOTE: All Spectrum Kits are available as Eyelet Pole Kits – please see our Trade Price List for codes. Pole Kits are supplied without finials. Add the finials of your choice to Pole Kit code.

Spectrum 50mm – Polished Silver Pole Kits

Polished Silver 50mm Complete Kits



Plain Ball – Polished Silver 50mm



Crackled Glass Ball – Polished Silver 50mm



Clear Crystal Beads – Polished Silver 50mm



Mirror Mosaic Ball – Polished Silver 50mm



Studded Ball – Polished Silver 50mm



Crystal Cut Diamond – Polished Silver 50mm



NEW Ribbed Ball – Polished Silver 50mm



FYNN – Polished Silver 50mm

50mm Spectrum Complete Kit Sizes Available:

1.20m (3'11") 1.50m (4'11") 1.80m (5'11") 2.40m (7'10")
3.00m* (9'10") 3.60m* (11'10") 4.80m* (15'9") 6.00m* (19'8")

* Denotes 2 piece pole with joiner and includes extra bracket

Packed:
Individual



Transport Packed

Kit includes:



NOTE: All Spectrum Kits are available as Eyelet Pole Kits – please see our Trade Price List for codes. Pole Kits are supplied without finials. Add the finials of your choice to Pole Kit code.

Spectrum 35mm – Polished Silver Pole Kits

Polished Silver 35mm Complete Kits



Plain Ball – Polished Silver 35mm



Crackled Glass Ball – Polished Silver 35mm



Clear Crystal Beads – Polished Silver 35mm



Mirror Mosaic Ball – Polished Silver 35mm



Studded Ball – Polished Silver 35mm



Crystal Cut Diamond – Polished Silver 35mm



NEW Ribbed Ball – Polished Silver 35mm



FYNN – Polished Silver 35mm

35mm Spectrum Complete Kit Sizes Available:

1.20m (3'11") 1.50m (4'11") 1.80m (5'11") 2.40m (7'10")
3.00m* (9'10") 3.60m* (11'10") 4.80m* (15'9") 6.00m* (19'8")

* Denotes 2 piece pole with joiner and includes extra bracket

Packed:
Individual



Transport Packed

Kit includes:



NOTE: All Spectrum Kits are available as Eyelet Pole Kits – please see our Trade Price List for codes. Pole Kits are supplied without finials. Add the finials of your choice to Pole Kit code.

DISCLAIMER: Whilst every effort has been made to ensure colour accuracy, due to the limitations of colour printing, please refer to product samples for colour matching. Product dimensions are for guidance only and may differ – please confirm details at time of ordering.

Spectrum 50mm – Titanium Pole Kits

Titanium 50mm Pole Complete Kits



Plain Ball – Titanium 50mm



Crackled Glass Ball – Titanium 50mm



Clear Crystal Beads – Titanium 50mm



Flat Dimple Ball – Titanium 50mm



Green Mosaic Ball – Titanium 50mm



Crystal Cut Diamond – Titanium 50mm



NEW Ribbed Ball – Titanium 50mm



FYNN – Titanium 50mm

50mm Spectrum Complete Kit Sizes Available:

1.20m (3'11") 1.50m (4'11") 1.80m (5'11") 2.40m (7'10")
3.00m* (9'10") 3.60m* (11'10") 4.80m* (15'9") 6.00m* (19'8")

* Denotes 2 piece pole with joiner and includes extra bracket

Packed:
Individual



Transport Packed

Kit includes:



NOTE: All Spectrum Kits are available as Eyelet Pole Kits – please see our Trade Price List for codes. Pole Kits are supplied without finials. Add the finials of your choice to Pole Kit code.

Spectrum 35mm – Titanium Pole Kits

Titanium 35mm Pole Complete Kits



Plain Ball – Titanium 35mm



Crackled Glass Ball – Titanium 35mm



Clear Crystal Beads – Titanium 35mm



Flat Dimple Ball – Titanium 35mm



Green Mosaic Ball – Titanium 35mm



Rose Mosaic Ball – Titanium 35mm



NEW Ribbed Ball – Titanium 35mm



Crystal Cut Diamond – Titanium 35mm



FYNN – Titanium 35mm

35mm Spectrum Complete Kit Sizes Available:

1.20m (3'11") 1.50m (4'11") 1.80m (5'11") 2.40m (7'10")
3.00m* (9'10") 3.60m* (11'10") 4.80m* (15'9") 6.00m* (19'8")

* Denotes 2 piece pole with joiner and includes extra bracket

Packed:
Individual



Transport Packed

Kit includes:



NOTE: All Spectrum Kits are available as Eyelet Pole Kits – please see our Trade Price List for codes. Pole Kits are supplied without finials. Add the finials of your choice to Pole Kit code.

DISCLAIMER: Whilst every effort has been made to ensure colour accuracy, due to the limitations of colour printing, please refer to product samples for colour matching. Product dimensions are for guidance only and may differ – please confirm details at time of ordering.



Dimensions Range

The 28mm Dimensions Range is a unique curtain pole range with the added bonus that allows you to choose your own perfect finial selection – with a wide range of finials available.

High quality complete Pole Kits are available in precious metal finishes available in with Dimensions Contemporary Brackets or Dimensions Options with adjustable K-Brackets.



Pole Diameter:
28mm

Contemporary Bracket

The Dimensions Contemporary range comes with a stylish contemporary bracket. Pole kits are available complete with rings or without rings as eyelet poles.



KG
HEAVY



Options Adjustable K-Bracket

The Dimensions Options range comes with a functional Adjustable K-Bracket. Pole kits are available complete with rings or without rings as eyelet poles.

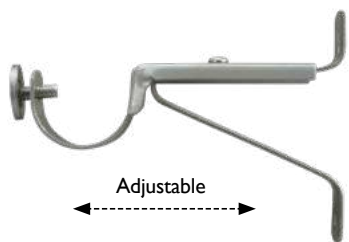

KG
MEDIUM



Colour finishes available:

TITANIUM

ANTIQUÉ BRASS

GUN METAL

POLISHED SILVER

POLISHED BRASS

BLACK NICKEL

MATT BLACK

Refer to the following pages to confirm finial colour availability.



Also available as Eyelet Pole Kits

For Eyelets see this Catalogue p206-210



Kit Components

Components	Pole Kit Sizes					
	1.20m (3'11")	1.60m (5'3")	2.00m (6'7")	2.40m* (7'10")	3.20m* (10'6")	4.00m* (13'1")
Pole	1 x 1.20m	1 x 1.60m	1 x 2.00m	2 x 1.20m	2 x 1.60m	2 x 2.00m
Brackets	2	2	2	3	3	3
Finials	2	2	2	2	2	2
Rings	12	16	20	24	32	40

* Denotes 2 piece pole with joiner and includes extra bracket. All kits include relevant fittings and instructions.

KG
MEDIUM
HEAVY

This curtain pole is suitable for medium-to-heavy weight curtains



Suitable for straight runs. Bay window option available.



Kits/components are delivered in transport or retail packaging



Available in contract components for large jobs



Available in kit form for simple ordering



Poles available made-to-measure

DISCLAIMER: Whilst every effort has been made to ensure colour accuracy, due to the limitations of colour printing, please refer to product samples for colour matching. Product dimensions are for guidance only and may differ – please confirm details at time of ordering.

28mm Dimensions Accessories

Finials

Collars fit over the pole by approximately 20mm

 <p>60mm 90mm</p> <p>Crackled Glass Ball Finial</p> 	 <p>60mm 85mm</p> <p>Clear Crystal Cut Diamond Finial</p> 	 <p>62mm 90mm</p> <p>Silver Mirror Mosaic Finial</p> 	 <p>62mm 90mm</p> <p>Black/Silver Mirror Mosaic Finial</p> 	 <p>62mm 83mm</p> <p>Clear Crystal Beads Finial</p> 	 <p>54mm 165mm</p> <p>Long Basket Finial</p> 
 <p>60mm 86mm</p> <p>Plain Ball Finial</p> 	 <p>34mm 33mm</p> <p>Barrel Finial</p> 	 <p>33mm 70mm</p> <p>Cylinder Finial</p> 	 <p>33mm 46mm</p> <p>Cube Finial</p> 	 <p>42mm 10mm</p> <p>FYNN Finial</p> 	

Packed: In pairs or part of a complete kit

Colour finishes available:

TITANIUM

ANTIQUÉ BRASS

GUN METAL

POLISHED SILVER

POLISHED BRASS

BLACK NICKEL

MATT BLACK

Please refer to the following pages to confirm finial colour availability.

Metal Rings



Metal Ring with Nylon Insert
Ensures Quieter Running

Packed: 8 px or part of a complete kit

Brackets

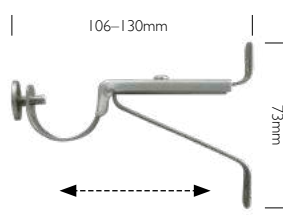

Adjustable K-Bracket
Included with Options kits

Packed: In pairs or part of a complete kit

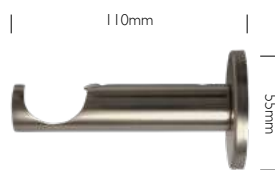

Contemporary Bracket
Included with Contemporary kits



Metal Recess Bracket

Packed: In pairs

Metal Holdbacks



Large Metal Holdback Arms

Packed: In pairs



Plain Ball Metal Holdbacks

Also available with Clear Crystal Beads or Clear Cut Crystal Diamonds.

Packed: In pairs

Metal Poles

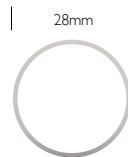

Single Length 28mm Metal Poles

Sizes: 2m and 2.4m
Packed: Individually

Pole Joiners

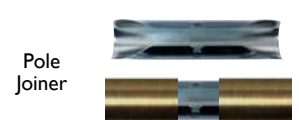

Pole Joiner

Multi-angle Joiner



Packed: Individually

DISCLAIMER: Whilst every effort has been made to ensure colour accuracy, due to the limitations of colour printing, please refer to product samples for colour matching. Product dimensions are for guidance only and may differ – please confirm details at time of ordering.

28mm Dimensions – Titanium Complete Kits

28mm Dimensions Contemporary Titanium Complete Kits



Clear Crystal Cut Diamond – Contemporary Titanium



Black/Silver Mirror Mosaic – Contemporary Titanium



Silver Mirror Mosaic – Contemporary Titanium



Beaded Glass Ball – Contemporary Titanium



Crackled Glass – Contemporary Titanium



Plain Ball – Contemporary Titanium



FYNN Finial – Contemporary Titanium

28mm Dimensions Complete Kit Sizes Available:

1.20m (3'11") 1.60m (5'3") 2.00m (6'7")
2.40m* (7'10") 3.20m* (10'6") 4.00m* (13'1")

* Denotes 2 piece pole with joiner and includes extra bracket

Packed: Individual or packed in outers of 4

Retail pack



Kit includes:



28mm Dimensions Options Titanium Complete Kits



Clear Crystal Cut Diamond – Options Titanium



Black/Silver Mirror Mosaic – Options Titanium



Silver Mirror Mosaic – Options Titanium



Beaded Glass Ball – Options Titanium



Crackled Glass – Options Titanium



Plain Ball – Options Titanium



FYNN Finial – Options Titanium

28mm Dimensions Complete Kit Sizes Available:

1.20m (3'11") 1.60m (5'3") 2.00m (6'7")
2.40m* (7'10") 3.20m* (10'6") 4.00m* (13'1")

* Denotes 2 piece pole with joiner and includes extra bracket

Packed: Individual or packed in outers of 4

Retail pack



Kit includes:



DISCLAIMER: Whilst every effort has been made to ensure colour accuracy, due to the limitations of colour printing, please refer to product samples for colour matching. Product dimensions are for guidance only and may differ – please confirm details at time of ordering.

28mm Dimensions – Titanium Eyelet Pole Kits

28mm Dimensions Contemporary Titanium Eyelet Pole Kits



Clear Crystal Cut Diamond – Contemporary Titanium



Black/Silver Mirror Mosaic – Contemporary Titanium



Silver Mirror Mosaic – Contemporary Titanium



Beaded Glass Ball – Contemporary Titanium



Crackled Glass – Contemporary Titanium



Plain Ball – Contemporary Titanium



FYNN Finial – Contemporary Titanium

28mm Dimensions Eyelet Pole Kit Sizes Available:

1.20m (3'11") 1.60m (5'3") 2.00m (6'7")
2.40m* (7'10") 3.20m* (10'6") 4.00m* (13'1")

* Denotes 2 piece pole with joiner and includes extra bracket

Packed:
Individual or packed in outers of 4

Retail pack

Kit includes:



Matching Eyelets:
See this Catalogue p206–210



28mm Dimensions Options Titanium Eyelet Pole Kits



Clear Crystal Cut Diamond – Options Titanium



Black/Silver Mirror Mosaic – Options Titanium



Silver Mirror Mosaic – Options Titanium



Beaded Glass Ball – Options Titanium



Crackled Glass – Options Titanium



Plain Ball – Options Titanium



FYNN Finial – Options Titanium

28mm Dimensions Eyelet Pole Kit Sizes Available:

1.20m (3'11") 1.60m (5'3") 2.00m (6'7")
2.40m* (7'10") 3.20m* (10'6") 4.00m* (13'1")

* Denotes 2 piece pole with joiner and includes extra bracket

Packed:
Individual or packed in outers of 4

Retail pack

Kit includes:



Matching Eyelets:
See this Catalogue p206–210



DISCLAIMER: Whilst every effort has been made to ensure colour accuracy, due to the limitations of colour printing, please refer to product samples for colour matching. Product dimensions are for guidance only and may differ – please confirm details at time of ordering.

28mm Dimensions – Antique Brass Complete Kits

28mm Dimensions Contemporary Antique Brass Complete Kits



Clear Crystal Cut Diamond – Contemporary Antique Brass



Cube – Contemporary Antique Brass



Barrel – Contemporary Antique Brass



Plain Ball – Contemporary Antique Brass



Long Basket – Contemporary Antique Brass



FYNN Finial – Contemporary Antique Brass



Crackled Glass – Contemporary Antique Brass

28mm Dimensions Complete Kit Sizes Available:

1.20m (3'11") 1.60m (5'3") 2.00m (6'7")
2.40m* (7'10") 3.20m* (10'6") 4.00m* (13'1")

* Denotes 2 piece pole with joiner and includes extra bracket

Packed: Individual or packed in outers of 4

Retail pack 

Kit includes:



28mm Dimensions Options Adjustable K-Bracket Antique Brass Complete Kits



Clear Crystal Cut Diamond – Options with Adjustable K-Bracket Antique Brass



Cube – Options with Adjustable K-Bracket Antique Brass

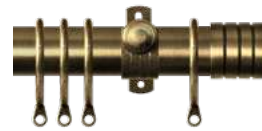

Barrel – Options with Adjustable K-Bracket Antique Brass



Plain Ball – Options with Adjustable K-Bracket Antique Brass



Long Basket – Options with Adjustable K-Bracket Antique Brass



FYNN Finial – Options with Adjustable K-Bracket Antique Brass



Crackled Glass – Options with Adjustable K-Bracket Antique Brass

28mm Dimensions Complete Kit Sizes Available:

1.20m (3'11") 1.60m (5'3") 2.00m (6'7")
2.40m* (7'10") 3.20m* (10'6") 4.00m* (13'1")

* Denotes 2 piece pole with joiner and includes extra bracket

Packed: Individual or packed in outers of 4

Retail pack 

Kit includes:



DISCLAIMER: Whilst every effort has been made to ensure colour accuracy, due to the limitations of colour printing, please refer to product samples for colour matching. Product dimensions are for guidance only and may differ – please confirm details at time of ordering.

28mm Dimensions – Antique Brass Eyelet Pole Kits

28mm Dimensions Contemporary Antique Brass Eyelet Pole Kits



Clear Crystal Cut Diamond – Contemporary Antique Brass



Cube – Contemporary Antique Brass



Barrel – Contemporary Antique Brass



Plain Ball – Contemporary Antique Brass



Long Basket – Contemporary Antique Brass



FYNN Finial – Contemporary Antique Brass



Crackled Glass – Contemporary Antique Brass

28mm Dimensions Eyelet Pole Kit Sizes Available:

1.20m (3'11") 1.60m (5'3") 2.00m (6'7")
2.40m* (7'10") 3.20m* (10'6") 4.00m* (13'1")

* Denotes 2 piece pole with joiner and includes extra bracket

Packed: Individual or packed in outers of 4

Retail pack 

Kit includes:



Matching Eyelets: See this Catalogue p206–210 

28mm Dimensions Options Adjustable K-Bracket Antique Brass Eyelet Pole Kits



Clear Crystal Cut Diamond – Options Adjustable K-Bracket Antique Brass



Cube – Options Adjustable K-Bracket Antique Brass



Barrel – Options with Adjustable K-Bracket Antique Brass



Plain Ball – Options with Adjustable K-Bracket Antique Brass



Long Basket – Options with Adjustable K-Bracket Antique Brass



FYNN Finial – Options with Adjustable K-Bracket Antique Brass



Crackled Glass – Options with Adjustable K-Bracket Antique Brass

28mm Dimensions Complete Kit Sizes Available:

1.20m (3'11") 1.60m (5'3") 2.00m (6'7")
2.40m* (7'10") 3.20m* (10'6") 4.00m* (13'1")

* Denotes 2 piece pole with joiner and includes extra bracket

Packed: Individual or packed in outers of 4

Retail pack 

Kit includes:



DISCLAIMER: Whilst every effort has been made to ensure colour accuracy, due to the limitations of colour printing, please refer to product samples for colour matching. Product dimensions are for guidance only and may differ – please confirm details at time of ordering.

28mm Dimensions – Polished Silver Complete Kits

28mm Dimensions Contemporary Polished Silver Complete Kits



Cracked Glass – Contemporary Polished Silver



Clear Crystal Cut Diamond – Contemporary Polished Silver



Silver Mirror Mosaic – Contemporary Polished Silver



Cube – Contemporary Polished Silver



Cylinder – Contemporary Polished Silver



Plain Ball – Contemporary Polished Silver



Clear Crystal Beads – Contemporary Polished Silver



FYNN Finial – Contemporary Polished Silver

28mm Dimensions Complete Kit Sizes Available:

1.20m (3'11") 1.60m (5'3") 2.00m (6'7")
2.40m* (7'10") 3.20m* (10'6") 4.00m* (13'1")

* Denotes 2 piece pole with joiner and includes extra bracket

Packed: Individual or packed in outers of 4

Retail pack 

Kit includes:



28mm Dimensions Options Adjustable K-Bracket Polished Silver Complete Kits



Cracked Glass – Options with Adjustable K-Bracket Polished Silver



Clear Crystal Cut Diamond – Options with Adjustable K-Bracket Polished Silver



Silver Mirror Mosaic – Options with Adjustable K-Bracket Polished Silver



Cube – Options with Adjustable K-Bracket Polished Silver



Cylinder – Options with Adjustable K-Bracket Polished Silver



Plain Ball – Options with Adjustable K-Bracket Polished Silver



Clear Crystal Beads – Options with Adjustable K-Bracket Polished Silver



FYNN Finial – Options with Adjustable K-Bracket Polished Silver

28mm Dimensions Complete Kit Sizes Available:

1.20m (3'11") 1.60m (5'3") 2.00m (6'7")
2.40m* (7'10") 3.20m* (10'6") 4.00m* (13'1")

* Denotes 2 piece pole with joiner and includes extra bracket

Packed: Individual or packed in outers of 4

Retail pack 

Kit includes:



DISCLAIMER: Whilst every effort has been made to ensure colour accuracy, due to the limitations of colour printing, please refer to product samples for colour matching. Product dimensions are for guidance only and may differ – please confirm details at time of ordering.

28mm Dimensions – Polished Silver Eyelet Pole Kits

28mm Dimensions Contemporary Polished Silver Eyelet Pole Kits



Crackled Glass – Contemporary Polished Silver



Clear Crystal Cut Diamond – Contemporary Polished Silver



Silver Mirror Mosaic – Contemporary Polished Silver



Cube – Contemporary Polished Silver



Cylinder – Contemporary Polished Silver



Plain Ball – Contemporary Polished Silver



Clear Crystal Beads – Contemporary Polished Silver



FYNN Finial – Contemporary Polished Silver

28mm Dimensions Eyelet Pole Kit Sizes Available:

1.20m (3'11") 1.60m (5'3") 2.00m (6'7")
2.40m* (7'10") 3.20m* (10'6") 4.00m* (13'1")

* Denotes 2 piece pole with joiner and includes extra bracket

Packed: Individual or packed in outers of 4

Retail pack 

Kit includes:



Matching Eyelets: See this Catalogue p206–210 

28mm Dimensions Options Adjustable K-Bracket Polished Silver Eyelet Pole Kits



Crackled Glass – Options with Adjustable K-Bracket Polished Silver



Clear Crystal Cut Diamond – Options with Adjustable K-Bracket Polished Silver



Silver Mirror Mosaic – Options with Adjustable K-Bracket Polished Silver



Cube – Options with Adjustable K-Bracket Polished Silver



Cylinder – Options with Adjustable K-Bracket Polished Silver



Plain Ball – Options with Adjustable K-Bracket Polished Silver



Clear Crystal Beads – Options with Adjustable K-Bracket Polished Silver



FYNN Finial – Options with Adjustable K-Bracket Polished Silver

28mm Dimensions Eyelet Pole Kit Sizes Available:

1.20m (3'11") 1.60m (5'3") 2.00m (6'7")
2.40m* (7'10") 3.20m* (10'6") 4.00m* (13'1")

* Denotes 2 piece pole with joiner and includes extra bracket

Packed: Individual or packed in outers of 4

Retail pack 

Kit includes:



Matching Eyelets: See this Catalogue p206–210 

DISCLAIMER: Whilst every effort has been made to ensure colour accuracy, due to the limitations of colour printing, please refer to product samples for colour matching. Product dimensions are for guidance only and may differ – please confirm details at time of ordering.

28mm Dimensions – Polished Brass Complete Kits

28mm Dimensions Contemporary Polished Brass Complete Kits



Cube – Contemporary Polished Brass



Cylinder – Contemporary Polished Brass



Plain Ball – Contemporary Polished Brass



FYNN Finial – Contemporary Polished Brass

28mm Dimensions Complete Kit Sizes Available:

1.20m (3'11") 1.60m (5'3") 2.00m (6'7")
 2.40m* (7'10") 3.20m* (10'6") 4.00m* (13'1")

* Denotes 2 piece pole with joiner and includes extra bracket

Packed: Individual or packed in outers of 4

Retail pack



Kit includes:



28mm Dimensions Options Adjustable K-Bracket Polished Brass Complete Kits

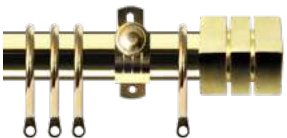

Cube – Options with Adjustable K-Bracket Polished Brass



Cylinder – Options with Adjustable K-Bracket Polished Brass



Plain Ball – Options with Adjustable K-Bracket Polished Brass

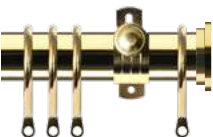

FYNN Finial – Options with Adjustable K-Bracket Polished Brass

28mm Dimensions Complete Kit Sizes Available:

1.20m (3'11") 1.60m (5'3") 2.00m (6'7")
 2.40m* (7'10") 3.20m* (10'6") 4.00m* (13'1")

* Denotes 2 piece pole with joiner and includes extra bracket

Packed: Individual or packed in outers of 4

Retail pack



Kit includes:



DISCLAIMER: Whilst every effort has been made to ensure colour accuracy, due to the limitations of colour printing, please refer to product samples for colour matching. Product dimensions are for guidance only and may differ – please confirm details at time of ordering.

28mm Dimensions – Polished Brass Eyelet Pole Kits

28mm Dimensions Contemporary Polished Brass Eyelet Pole Kits



Cube – Contemporary Polished Brass



Cylinder – Contemporary Polished Brass



Plain Ball – Contemporary Polished Brass



FYNN Finial – Contemporary Polished Brass

28mm Dimensions Eyelet Pole Kit Sizes Available:

1.20m (3'11") 1.60m (5'3") 2.00m (6'7")
2.40m* (7'10") 3.20m* (10'6") 4.00m* (13'1")

* Denotes 2 piece pole with joiner and includes extra bracket

Packed: Individual or packed in outers of 4

Retail pack



Kit includes:



Matching Eyelets:

See this Catalogue p206–210



28mm Dimensions Options Adjustable K-Bracket Polished Brass Eyelet Pole Kits



Cube – Options with Adjustable K-Bracket Polished Brass



Cylinder – Options with Adjustable K-Bracket Polished Brass



Plain Ball – Options with Adjustable K-Bracket Polished Brass



FYNN Finial – Options with Adjustable K-Bracket Polished Brass

28mm Dimensions Eyelet Pole Kit Sizes Available:

1.20m (3'11") 1.60m (5'3") 2.00m (6'7")
2.40m* (7'10") 3.20m* (10'6") 4.00m* (13'1")

* Denotes 2 piece pole with joiner and includes extra bracket

Packed: Individual or packed in outers of 4

Retail pack



Kit includes:



Matching Eyelets:

See this Catalogue p206–210



DISCLAIMER: Whilst every effort has been made to ensure colour accuracy, due to the limitations of colour printing, please refer to product samples for colour matching. Product dimensions are for guidance only and may differ – please confirm details at time of ordering.



28mm Dimensions – Black Nickel Complete Kits

28mm Dimensions Contemporary Black Nickel Complete Kits



Crackled Glass – Contemporary Black Nickel



Clear Crystal Cut Diamond – Contemporary Black Nickel



Black/Silver Mirror Mosaic – Contemporary Black Nickel



Cube – Contemporary Black Nickel



Cylinder – Contemporary Black Nickel



Plain Ball – Contemporary Black Nickel



FYNN Finial – Contemporary Black Nickel

28mm Dimensions Complete Kit Sizes Available:

1.20m (3'11") 1.60m (5'3") 2.00m (6'7")
2.40m* (7'10") 3.20m* (10'6") 4.00m* (13'1")

* Denotes 2 piece pole with joiner and includes extra bracket

Packed: Individual or packed in outers of 4

Retail pack



Kit includes:



28mm Dimensions Options Adjustable K-Bracket Black Nickel Complete Kits



Crackled Glass – Options with Adjustable K-Bracket Black Nickel



Clear Crystal Cut Diamond – Options with Adjustable K-Bracket Black Nickel



Black/Silver Mirror Mosaic – Options with Adjustable K-Bracket Black Nickel



Cube – Options with Adjustable K-Bracket Black Nickel



Cylinder – Options with Adjustable K-Bracket Black Nickel



Plain Ball – Options with Adjustable K-Bracket Black Nickel



FYNN Finial – Options with Adjustable K-Bracket Black Nickel

28mm Dimensions Complete Kit Sizes Available:

1.20m (3'11") 1.60m (5'3") 2.00m (6'7")
2.40m* (7'10") 3.20m* (10'6") 4.00m* (13'1")

* Denotes 2 piece pole with joiner and includes extra bracket

Packed: Individual or packed in outers of 4

Retail pack



Kit includes:



DISCLAIMER: Whilst every effort has been made to ensure colour accuracy, due to the limitations of colour printing, please refer to product samples for colour matching. Product dimensions are for guidance only and may differ – please confirm details at time of ordering.

28mm Dimensions – Black Nickel Eyelet Pole Kits

28mm Dimensions Contemporary Black Nickel Complete Kits



Crackled Glass – Contemporary Black Nickel



Clear Crystal Cut Diamond – Contemporary Black Nickel



Black/Silver Mirror Mosaic – Contemporary Black Nickel



Cube – Contemporary Black Nickel



Cylinder – Contemporary Black Nickel



Plain Ball – Contemporary Black Nickel



FYNN Finial – Contemporary Black Nickel

28mm Dimensions Eyelet Pole Kit Sizes Available:

1.20m (3'11") 1.60m (5'3") 2.00m (6'7") * Denotes 2 piece pole with joiner and includes extra bracket
2.40m* (7'10") 3.20m* (10'6") 4.00m* (13'1")

Packed: Individual or packed in outers of 4



Kit includes:



Matching Eyelets: See this Catalogue p206–210



28mm Dimensions Options Adjustable K-Bracket Black Nickel Complete Kits



Crackled Glass – Options with Adjustable K-Bracket Black Nickel



Clear Crystal – Options with Adjustable K-Bracket Black Nickel



Black/Silver Mirror Mosaic – Options with Adjustable K-Bracket Black Nickel



Cube – Options with Adjustable K-Bracket Black Nickel



Cylinder – Options with Adjustable K-Bracket Black Nickel



Plain Ball – Options with Adjustable K-Bracket Black Nickel



FYNN Finial – Options with Adjustable K-Bracket Black Nickel

28mm Dimensions Eyelet Pole Kit Sizes Available:

1.20m (3'11") 1.60m (5'3") 2.00m (6'7") * Denotes 2 piece pole with joiner and includes extra bracket
2.40m* (7'10") 3.20m* (10'6") 4.00m* (13'1")

Packed: Individual or packed in outers of 4



Kit includes:



Matching Eyelets: See this Catalogue p206–210



DISCLAIMER: Whilst every effort has been made to ensure colour accuracy, due to the limitations of colour printing, please refer to product samples for colour matching. Product dimensions are for guidance only and may differ – please confirm details at time of ordering.

28mm Dimensions – Gun Metal Complete Kits

28mm Dimensions Contemporary Gun Metal Complete Kits



Clear Crystal Cut Diamond – Contemporary Gun Metal



Plain Ball – Contemporary Gun Metal



Crackled Glass – Contemporary Gun Metal

28mm Dimensions Complete Kit Sizes Available:

1.20m (3'11") 1.60m (5'3") 2.00m (6'7")
2.40m* (7'10") 3.20m* (10'6") 4.00m* (13'1")

* Denotes 2 piece pole with joiner and includes extra bracket

Packed: Individual or packed in outers of 4



Kit includes:



28mm Dimensions Options Adjustable K-Bracket Gun Metal Complete Kits



Clear Crystal Cut Diamond – Options with Adjustable K-Bracket Gun Metal



Plain Ball – Options with Adjustable K-Bracket Gun Metal



Crackled Glass – Options with Adjustable K-Bracket Gun Metal

28mm Dimensions Complete Kit Sizes Available:

1.20m (3'11") 1.60m (5'3") 2.00m (6'7")
2.40m* (7'10") 3.20m* (10'6") 4.00m* (13'1")

* Denotes 2 piece pole with joiner and includes extra bracket

Packed: Individual or packed in outers of 4



Kit includes:



28mm Dimensions – Gun Metal Eyelet Pole Kits

28mm Dimensions Contemporary Gun Metal Eyelet Pole Kits



Clear Crystal Cut Diamond – Contemporary Gun Metal



Plain Ball – Contemporary Gun Metal



Crackled Glass – Contemporary Gun Metal

28mm Dimensions Eyelet Pole Kit Sizes Available:

1.20m (3'11") 1.60m (5'3") 2.00m (6'7")
2.40m* (7'10") 3.20m* (10'6") 4.00m* (13'1")

* Denotes 2 piece pole with joiner and includes extra bracket

Packed: Individual or packed in outers of 4



Kit includes:



Matching Eyelets:

See this Catalogue p206-210



28mm Dimensions Options Adjustable K-Bracket Gun Metal Eyelet Pole Kits



Clear Crystal Cut Diamond – Options with Adjustable K-Bracket Gun Metal



Plain Ball – Options with Adjustable K-Bracket Gun Metal



Crackled Glass – Options with Adjustable K-Bracket Gun Metal

28mm Dimensions Eyelet Pole Kit Sizes Available:

1.20m (3'11") 1.60m (5'3") 2.00m (6'7")
2.40m* (7'10") 3.20m* (10'6") 4.00m* (13'1")

* Denotes 2 piece pole with joiner and includes extra bracket

Packed: Individual or packed in outers of 4



Kit includes:



Matching Eyelets:

See this Catalogue p206-210



28mm Dimensions – Matt Black Complete Kits

28mm Dimensions Contemporary Matt Black Complete Kits



Plain Ball – Contemporary Matt Black



Long Basket – Contemporary Matt Black



FYNN Finial – Contemporary Matt Black

28mm Dimensions Complete Kit Sizes Available:

1.20m (3'11") 1.60m (5'3") 2.00m (6'7")
2.40m* (7'10") 3.20m* (10'6") 4.00m* (13'1")

* Denotes 2 piece pole with joiner and includes extra bracket

Packed: Individual or packed in outers of 4



Kit includes:



28mm Dimensions Options Adjustable K-Bracket Matt Black Complete Kits



Plain Ball – Options with Adjustable K-Bracket Matt Black



Long Basket – Options with Adjustable K-Bracket Matt Black



FYNN Finial – Options with Adjustable K-Bracket Matt Black

28mm Dimensions Complete Kit Sizes Available:

1.20m (3'11") 1.60m (5'3") 2.00m (6'7")
2.40m* (7'10") 3.20m* (10'6") 4.00m* (13'1")

* Denotes 2 piece pole with joiner and includes extra bracket

Packed: Individual or packed in outers of 4



Kit includes:



28mm Dimensions – Matt Black Eyelet Pole Kits

28mm Dimensions Contemporary Matt Black Eyelet Pole Kits



Plain Ball – Contemporary Matt Black



Long Basket – Contemporary Matt Black



FYNN Finial – Contemporary Matt Black

28mm Dimensions Eyelet Pole Kit Sizes Available:

1.20m (3'11") 1.60m (5'3") 2.00m (6'7")
2.40m* (7'10") 3.20m* (10'6") 4.00m* (13'1")

* Denotes 2 piece pole with joiner and includes extra bracket

Packed: Individual or packed in outers of 4



Kit includes:



Matching Eyelets: See this Catalogue p206–210



28mm Dimensions Options Adjustable K-Bracket Matt Black Eyelet Pole Kits



Plain Ball – Options with Adjustable K-Bracket Matt Black



Long Basket – Options with Adjustable K-Bracket Matt Black



FYNN Finial – Options with Adjustable K-Bracket Matt Black

28mm Dimensions Eyelet Pole Kit Sizes Available:

1.20m (3'11") 1.60m (5'3") 2.00m (6'7")
2.40m* (7'10") 3.20m* (10'6") 4.00m* (13'1")

* Denotes 2 piece pole with joiner and includes extra bracket

Packed: Individual or packed in outers of 4



Kit includes:



Matching Eyelets: See this Catalogue p206–210



DISCLAIMER: Whilst every effort has been made to ensure colour accuracy, due to the limitations of colour printing, please refer to product samples for colour matching. Product dimensions are for guidance only and may differ – please confirm details at time of ordering.

Contract 35 Range

Contract 35mm Metal Curtain Poles are available in loose contract form or as complete kits. Single length poles are available up to 3m – ideal for longer windows or situations where minimal wastage is required on larger projects.

Available with a Contemporary Bracket or a strong Adjustable K-bracket and a choice of two finials – Plain Ball or End Cap.



Contract 35 with Adjustable K-Bracket and End Cap

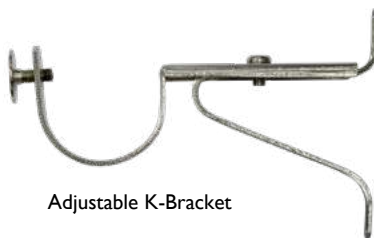

Adjustable K-Bracket

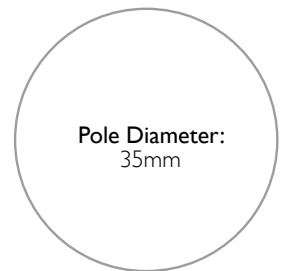

Contract 35 with Plain Ball Finial

Colour finishes available:

- BLACK NICKEL
- ANTIQUÉ BRASS
- POLISHED SILVER
- BRUSHED NICKEL
- MATT BLACK

Refer to the following pages to confirm finial colour availability.

Contract 35 Kit Components

Single length poles available up to 3.00m on request

Components	Pole Kit Sizes							
	1.20m (3'11")	1.50m (4'11")	1.80m (5'11")	2.40m (7'10")	3.00m* (9'10")	3.60m* (11'10")	4.80m*(15'9")	6.00m* (19'8")
Pole	1 x 1.20m	1 x 1.50m	1 x 1.80m	1 x 2.40m	2 x 1.50m	2 x 1.80m	2 x 2.40m	2 x 3.00m
Brackets	2	2	2	3	3	3	3	3
Finials	2	2	2	2	2	2	2	2
Rings	12	16	18	24	30	36	48	60

*Denotes 2 piece pole with joiner. All kits include relevant fittings and instructions.
NOTE: 3m single length poles are available to special order and **must** be specified at point of order.

- This curtain pole is suitable for medium-to-heavy weight curtains
- Suitable for straight runs ONLY
- Kits/components are delivered in transport packaging
- Available in contract components for large jobs
- Available in kit form for simple ordering
- Poles available made-to-measure

DISCLAIMER: Whilst every effort has been made to ensure colour accuracy, due to the limitations of colour printing, please refer to product samples for colour matching. Product dimensions are for guidance only and may differ – please confirm details at time of ordering.

Contract 35mm Components

35mm Finials



Packed: Individually or part of a complete kit

35mm Rings



Packed: Individually or part of a complete kit

Matching Holdbacks



Packed: Pairs

35mm Brackets

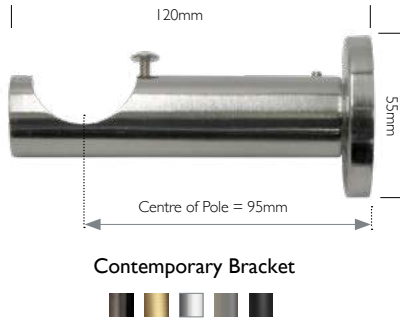

Packed: Individually or part of a complete kit

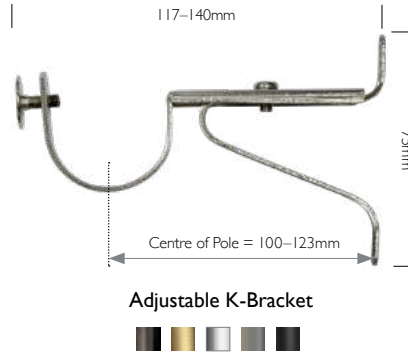

Packed: Individually or part of a complete kit



Packed: Individually

Matching Metal Draw Rods



Contemporary Metal Draw Rod



Available in sizes: 100cm (39") • 125cm (49") • 150cm (59") • 200cm (79")

Packed: Individually

35mm Poles and Joiners

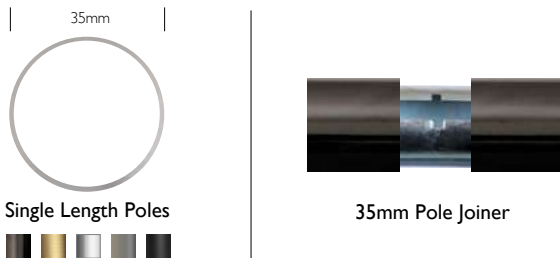

Single Length Poles



Size: Available up to 3.00m

35mm Pole Joiner

Packed: Individually

BLACK NICKEL

ANTIQUÉ BRASS

POLISHED SILVER

BRUSHED NICKEL

MATT BLACK

DISCLAIMER: Whilst every effort has been made to ensure colour accuracy, due to the limitations of colour printing, please refer to product samples for colour matching. Product dimensions are for guidance only and may differ – please confirm details at time of ordering.

Contract 35mm Complete Kits

Antique Brass Complete Kit with Contemporary Brackets



Plain Ball – Contemporary Bracket Antique Brass

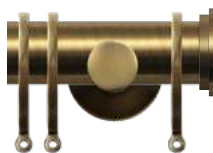

End Cap – Contemporary Bracket Antique Brass

Contract 35mm Complete Kit Sizes Available:

1.20m (3'11") 1.50m (4'11") 1.80m (5'11") 2.40m (7'10")
3.00m* (9'10") 3.60m* (11'10") 4.80m* (15'9") 6.00m* (19'8")

* Denotes 2 piece pole with joiner and includes extra bracket

Packed: Individual Transport Packed

Kit includes:



Brushed Nickel Complete Kit with Contemporary Brackets



Plain Ball – Contemporary Bracket Brushed Nickel



End Cap – Contemporary Bracket Brushed Nickel

Contract 35mm Complete Kit Sizes Available:

1.20m (3'11") 1.50m (4'11") 1.80m (5'11") 2.40m (7'10")
3.00m* (9'10") 3.60m* (11'10") 4.80m* (15'9") 6.00m* (19'8")

* Denotes 2 piece pole with joiner and includes extra bracket

Packed: Individual Transport Packed

Kit includes:



Black Nickel Complete Kit with Contemporary Brackets



Plain Ball – Contemporary Bracket Black Nickel



End Cap – Contemporary Bracket Black Nickel

Contract 35mm Complete Kit Sizes Available:

1.20m (3'11") 1.50m (4'11") 1.80m (5'11") 2.40m (7'10")
3.00m* (9'10") 3.60m* (11'10") 4.80m* (15'9") 6.00m* (19'8")

* Denotes 2 piece pole with joiner and includes extra bracket

Packed: Individual Transport Packed

Kit includes:



Polished Silver Complete Kit with Contemporary Brackets



Plain Ball – Contemporary Bracket Polished Silver



End Cap – Contemporary Bracket Polished Silver

Contract 35mm Complete Kit Sizes Available:

1.20m (3'11") 1.50m (4'11") 1.80m (5'11") 2.40m (7'10")
3.00m* (9'10") 3.60m* (11'10") 4.80m* (15'9") 6.00m* (19'8")

* Denotes 2 piece pole with joiner and includes extra bracket

Packed: Individual Transport Packed

Kit includes:



Matt Black Complete Kit with Contemporary Brackets



Plain Ball – Contemporary Bracket Matt Black



End Cap – Contemporary Bracket Matt Black

Contract 35mm Complete Kit Sizes Available:

1.20m (3'11") 1.50m (4'11") 1.80m (5'11") 2.40m (7'10")
3.00m* (9'10") 3.60m* (11'10") 4.80m* (15'9") 6.00m* (19'8")

* Denotes 2 piece pole with joiner and includes extra bracket

Packed: Individual Transport Packed

Kit includes:



DISCLAIMER: Whilst every effort has been made to ensure colour accuracy, due to the limitations of colour printing, please refer to product samples for colour matching. Product dimensions are for guidance only and may differ – please confirm details at time of ordering.

Contract 35mm Complete Kits

Antique Brass Complete Kit with Adjustable K-Brackets

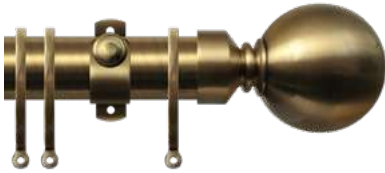

Plain Ball – Adjustable K-Bracket Antique Brass

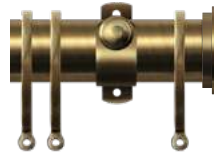

End Cap – Adjustable K-Bracket Antique Brass

Contract 35mm Complete Kit Sizes Available:

1.20m (3'11") 1.50m (4'11") 1.80m (5'11") 2.40m (7'10")
3.00m* (9'10") 3.60m* (11'10") 4.80m* (15'9") 6.00m* (19'8")

* Denotes 2 piece pole with joiner and includes extra bracket

Packed: Individual  Transport Packed

Kit includes:



Brushed Nickel Complete Kit with Adjustable K-Brackets



Plain Ball – Adjustable K-Bracket Brushed Nickel

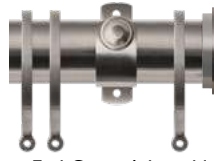

End Cap – Adjustable K-Bracket Brushed Nickel

Contract 35mm Complete Kit Sizes Available:

1.20m (3'11") 1.50m (4'11") 1.80m (5'11") 2.40m (7'10")
3.00m* (9'10") 3.60m* (11'10") 4.80m* (15'9") 6.00m* (19'8")

* Denotes 2 piece pole with joiner and includes extra bracket

Packed: Individual  Transport Packed

Kit includes:



Black Nickel Complete Kit with Adjustable K-Brackets



Plain Ball – Adjustable K-Bracket Black Nickel



End Cap – Adjustable K-Bracket Black Nickel

Contract 35mm Complete Kit Sizes Available:

1.20m (3'11") 1.50m (4'11") 1.80m (5'11") 2.40m (7'10")
3.00m* (9'10") 3.60m* (11'10") 4.80m* (15'9") 6.00m* (19'8")

* Denotes 2 piece pole with joiner and includes extra bracket

Packed: Individual  Transport Packed

Kit includes:



Polished Silver Complete Kit with Adjustable K-Brackets



Plain Ball – Adjustable K-Bracket Polished Silver



End Cap – Adjustable K-Bracket Polished Silver

Contract 35mm Complete Kit Sizes Available:

1.20m (3'11") 1.50m (4'11") 1.80m (5'11") 2.40m (7'10")
3.00m* (9'10") 3.60m* (11'10") 4.80m* (15'9") 6.00m* (19'8")

* Denotes 2 piece pole with joiner and includes extra bracket

Packed: Individual  Transport Packed

Kit includes:



Matt Black Complete Kit with Adjustable K-Brackets



Plain Ball – Adjustable K-Bracket Matt Black

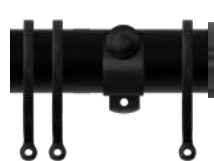

End Cap – Adjustable K-Bracket Matt Black

Contract 35mm Complete Kit Sizes Available:

1.20m (3'11") 1.50m (4'11") 1.80m (5'11") 2.40m (7'10")
3.00m* (9'10") 3.60m* (11'10") 4.80m* (15'9") 6.00m* (19'8")

* Denotes 2 piece pole with joiner and includes extra bracket

Packed: Individual  Transport Packed

Kit includes:



DISCLAIMER: Whilst every effort has been made to ensure colour accuracy, due to the limitations of colour printing, please refer to product samples for colour matching. Product dimensions are for guidance only and may differ – please confirm details at time of ordering.

Contract 28 Range

Contract 28mm Curtain Poles are available in loose contract form or as complete kits with a variety of bracket options. Pole set Bracket options include: Contemporary, Ceiling, Extendable Cup, Adjustable K-Brackets or L-Brackets.

Note Standard Kits include non-lined Rings. Contract 28 Lined Rings are also available in component form.

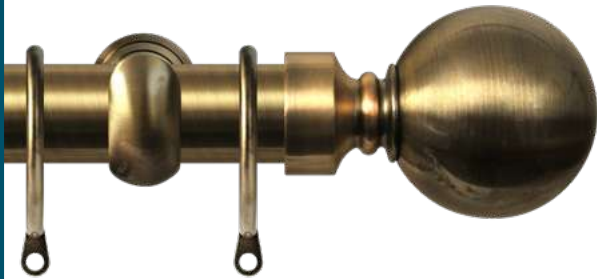

Contract 28 with Extendable Cup Brackets and Plain Ball Finial



Also available as Eyelet Pole Kits Contemporary, Adjustable K-Bracket or Standard Brackets only

Pole Diameter:
28mm



Contract 28 with Short Ceiling Bracket and End Cap



For Eyelets see this Catalogue p206-210

Other brackets available in Contract 28 Kits include:



Adjustable K-Bracket



Contemporary Bracket



Short L-Bracket



Long L-Bracket

Colour finishes available:

- BLACK NICKEL
- ANTIQUÉ BRASS
- POLISHED SILVER
- BRUSHED NICKEL
- MATT BLACK

Refer to the following pages to confirm finial colour availability.

Contract 28 Kit Components

Component	Pole Kit Sizes					
	1.20m (3'11")	1.50m (4'11")	2.00m (6'7")	2.40m* (7'10")	3.00m* (9'10")	4.00m* (13'1")
Pole	1 x 1.2m	1 x 1.5m	1 x 2m	2 x 1.2m	2 x 1.5m	2 x 2m
Brackets	2	2	2	3	3	3
Finials	2	2	2	2	2	2
Non-Lined Rings	12	16	20	24	32	40

NOTE: Standard Kits are supplied with non-lined Rings

*Denotes 2 piece pole with joiner. All kits include relevant fittings and instructions.

- KG**
MEDIUM
HEAVY

This curtain pole is suitable for medium-to-heavy weight curtains
- Suitable for straight runs. Bay window option available.
- Kits/components are delivered in transport packaging
- Available in contract components for large jobs
- Available in kit form for simple ordering
- Poles available made-to-measure

DISCLAIMER: Whilst every effort has been made to ensure colour accuracy, due to the limitations of colour printing, please refer to product samples for colour matching. Product dimensions are for guidance only and may differ – please confirm details at time of ordering.

Contract 28mm Components

Contract 28mm Finials



Packed: Individually or part of a complete kit

Contract 28mm Poles



Single Length Poles



Available Sizes:
1.2m, 1.5m, 2.0m, 2.4m & 3.0m
(5m also available in Brushed Nickel & Polished Silver)

Packed: Individually or part of a complete kit

Pole Joiners

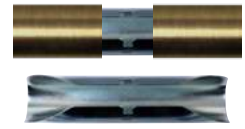

28mm Pole Joiner



Multiangle Pole Joiner



Packed: Individually

Contract 28mm Rings

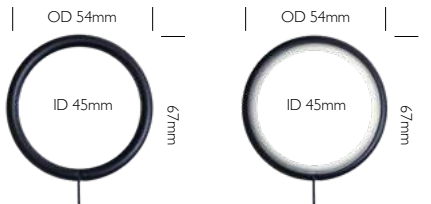

Non-Lined
Metal Ring*

Metal Ring with Nylon Insert
Ensures Quieter Running



Packed: Individually or *part of a complete kit

Metal Holdbacks



Large Metal Holdback Arms



Packed: In pairs



Plain Ball Metal Holdbacks



Packed: In pairs

Contract 28mm Brackets

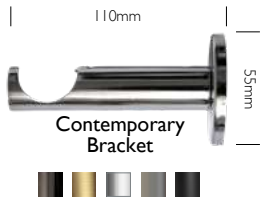

Contemporary
Bracket

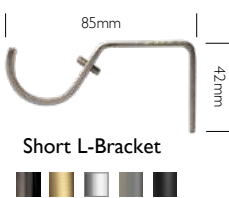

Short L-Bracket



Long L-Bracket

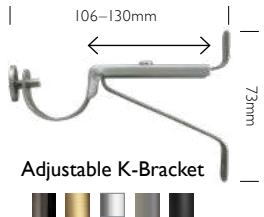

Adjustable K-Bracket

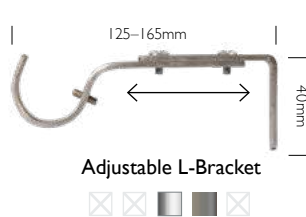

Adjustable L-Bracket

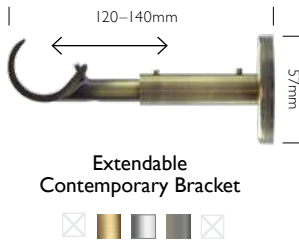

Extendable
Contemporary Bracket



Extendable Cup Bracket

This bracket can be shortened. Short version also available.

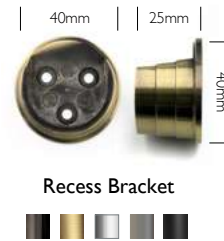

Recess Bracket



Long Ceiling Bracket



Short Ceiling Bracket



Packed: Individually or part of a complete kit

BLACK
NICKEL

ANTIQUE BRASS

POLISHED SILVER

BRUSHED NICKEL

MATT BACK

DISCLAIMER: Whilst every effort has been made to ensure colour accuracy, due to the limitations of colour printing, please refer to product samples for colour matching. Product dimensions are for guidance only and may differ – please confirm details at time of ordering.

Contract 28mm – Antique Brass Complete Kits

Antique Brass Complete Kit with Contemporary Brackets



Plain Ball
Antique Brass – Contemporary Bracket



End Cap
Antique Brass – Contemporary Bracket

Contract 28mm Complete Kit Sizes Available:

1.20m (3'11") 1.50m (4'11") 2.00m (6'7")
2.40m*(7'10") 3.00m*(9'10") 4.00m*(13'1")

* Denotes 2 piece pole with joiner and includes extra bracket

Packed: Individual Transport Packed

Kit includes:



Antique Brass Complete Kit with Short L-Brackets



Plain Ball
Antique Brass – Short L-Bracket



End Cap
Antique Brass – Short L-Bracket



Contract 28mm Complete Kit Sizes Available:

1.20m (3'11") 1.50m (4'11") 2.00m (6'7")
2.40m*(7'10") 3.00m*(9'10") 4.00m*(13'1")

* Denotes 2 piece pole with joiner and includes extra bracket

Packed: Individual Transport Packed

Kit includes:



Antique Brass Complete Kit with Short Ceiling Brackets

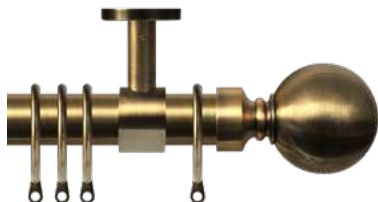

Plain Ball
Antique Brass – Short Ceiling Bracket



End Cap
Antique Brass – Short Ceiling Bracket



Contract 28mm Complete Kit Sizes Available:

1.20m (3'11") 1.50m (4'11") 2.00m (6'7")
2.40m*(7'10") 3.00m*(9'10") 4.00m*(13'1")

* Denotes 2 piece pole with joiner and includes extra bracket

Packed: Individual Transport Packed

Kit includes:



Antique Brass Complete Kit with Extendable Cup Brackets



Plain Ball
Antique Brass – Extendable Cup Bracket



End Cap
Antique Brass – Extendable Cup Bracket

Contract 28mm Complete Kit Sizes Available:

1.20m (3'11") 1.50m (4'11") 2.00m (6'7")
2.40m*(7'10") 3.00m*(9'10") 4.00m*(13'1")

* Denotes 2 piece pole with joiner and includes extra bracket

Packed: Individual Transport Packed

Kit includes:



DISCLAIMER: Whilst every effort has been made to ensure colour accuracy, due to the limitations of colour printing, please refer to product samples for colour matching. Product dimensions are for guidance only and may differ – please confirm details at time of ordering.

Contract 28mm – Antique Brass Eyelet Pole Kits

Antique Brass Eyelet Pole Kit with Contemporary Brackets





Plain Ball
Antique Brass – Contemporary Bracket



End Cap
Antique Brass – Contemporary Bracket

Contract 28mm Eyelet Pole Kit Sizes Available:
1.20m (3'11") 1.50m (4'11") 2.00m (6'7")
2.40m*(7'10") 3.00m*(9'10") 4.00m*(13'1")

* Denotes 2 piece pole with joiner and includes extra bracket

Packed:
Individual 
Transport Packed 

Kit includes: 

Matching Eyelets:
See this Catalogue p206-210 

Antique Brass Eyelet Pole Kit with Long L-Brackets





Plain Ball
Antique Brass – Long L-Bracket



End Cap
Antique Brass – Long L-Bracket

Contract 28mm Eyelet Pole Kit Sizes Available:
1.20m (3'11") 1.50m (4'11") 2.00m (6'7")
2.40m*(7'10") 3.00m*(9'10") 4.00m*(13'1")

* Denotes 2 piece pole with joiner and includes extra bracket

Packed:
Individual 
Transport Packed 

Kit includes:  110mm

Matching Eyelets:
See this Catalogue p206-210 

Antique Brass Eyelet Pole Kit with Adjustable K-Brackets





Plain Ball
Antique Brass – Adjustable K-Bracket



End Cap
Antique Brass – Adjustable K-Bracket

Contract 28mm Eyelet Pole Kit Sizes Available:
1.20m (3'11") 1.50m (4'11") 2.00m (6'7")
2.40m*(7'10") 3.00m*(9'10") 4.00m*(13'1")

* Denotes 2 piece pole with joiner and includes extra bracket

Packed:
Individual 
Transport Packed 

Kit includes: 

Matching Eyelets:
See this Catalogue p206-210 

Contract 28mm – Brushed Nickel Complete Kits

Brushed Nickel Complete Kit with Contemporary Brackets



Plain Ball
Brushed Nickel – Contemporary Bracket



End Cap
Brushed Nickel – Contemporary Bracket

Contract 28mm Complete Kit Sizes Available:
 1.20m (3'11") 1.50m (4'11") 2.00m (6'7")
 2.40m*(7'10") 3.00m*(9'10") 4.00m*(13'11")

* Denotes 2 piece pole with joiner and includes extra bracket

Packed: Individual Transport Packed

Kit includes:

Brushed Nickel Complete Kit with Short L-Brackets



Plain Ball
Brushed Nickel – Short L-Bracket

Also available in:
Long L-Brackets Complete kits
 Length 110mm



End Cap
Brushed Nickel – Short L-Bracket

Also available in:
Long L-Brackets Complete kits
 Length 110mm

Contract 28mm Complete Kit Sizes Available:
 1.20m (3'11") 1.50m (4'11") 2.00m (6'7")
 2.40m*(7'10") 3.00m*(9'10") 4.00m*(13'11")

* Denotes 2 piece pole with joiner and includes extra bracket

Packed: Individual Transport Packed

Kit includes: 85mm

Brushed Nickel Complete Kit with Short Ceiling Brackets



Plain Ball
Brushed Nickel – Short Ceiling Bracket

Also available in:
Adjustable K-Bracket Complete kits



End Cap
Brushed Nickel – Short Ceiling Bracket

Also available in:
Adjustable K-Bracket Complete kits

Contract 28mm Complete Kit Sizes Available:
 1.20m (3'11") 1.50m (4'11") 2.00m (6'7")
 2.40m*(7'10") 3.00m*(9'10") 4.00m*(13'11")

* Denotes 2 piece pole with joiner and includes extra bracket

Packed: Individual Transport Packed

Kit includes:

Brushed Nickel Complete Kit with Extendable Cup Brackets



Plain Ball
Brushed Nickel – Extendable Cup Bracket



End Cap
Brushed Nickel – Extendable Cup Bracket

Contract 28mm Complete Kit Sizes Available:
 1.20m (3'11") 1.50m (4'11") 2.00m (6'7")
 2.40m*(7'10") 3.00m*(9'10") 4.00m*(13'11")

* Denotes 2 piece pole with joiner and includes extra bracket

Packed: Individual Transport Packed

Kit includes:

DISCLAIMER: Whilst every effort has been made to ensure colour accuracy, due to the limitations of colour printing, please refer to product samples for colour matching. Product dimensions are for guidance only and may differ – please confirm details at time of ordering.

Contract 28mm – Brushed Nickel Eyelet Pole Kits

Brushed Nickel Eyelet Pole Kit with Contemporary Brackets



Plain Ball
Brushed Nickel – Contemporary Bracket



End Cap
Brushed Nickel – Contemporary Bracket

Contract 28mm Eyelet Pole Kit Sizes Available:
1.20m (3'11") 1.50m (4'11") 2.00m (6'7")
2.40m*(7'10") 3.00m*(9'10") 4.00m*(13'1")

* Denotes 2 piece pole with joiner and includes extra bracket

Packed:
Individual 
Transport Packed 



Matching Eyelets:
See this Catalogue p206-210 

Brushed Nickel Eyelet Pole Kit with Long L-Brackets





Plain Ball
Brushed Nickel – Long L-Bracket



End Cap
Brushed Nickel – Long L-Bracket

Contract 28mm Eyelet Pole Kit Sizes Available:
1.20m (3'11") 1.50m (4'11") 2.00m (6'7")
2.40m*(7'10") 3.00m*(9'10") 4.00m*(13'1")

* Denotes 2 piece pole with joiner and includes extra bracket

Packed:
Individual 
Transport Packed 



Matching Eyelets:
See this Catalogue p206-210 

Brushed Nickel Eyelet Pole Kit with Adjustable K-Brackets





Plain Ball
Brushed Nickel – Adjustable K-Bracket



End Cap
Brushed Nickel – Adjustable K-Bracket

Contract 28mm Eyelet Pole Kit Sizes Available:
1.20m (3'11") 1.50m (4'11") 2.00m (6'7")
2.40m*(7'10") 3.00m*(9'10") 4.00m*(13'1")

* Denotes 2 piece pole with joiner and includes extra bracket

Packed:
Individual 
Transport Packed 



Matching Eyelets:
See this Catalogue p206-210 

Contract 28mm – Matt Black Complete Kits

Matt Black Complete Kit with Contemporary Brackets



Plain Ball
Matt Black – Contemporary Bracket



End Cap
Matt Black – Contemporary Bracket

Contract 28mm Complete Kit Sizes Available:

- 1.20m (3'11")
- 1.50m (4'11")
- 2.00m (6'7")
- 2.40m*(7'10")
- 3.00m*(9'10")
- 4.00m*(13'1")

* Denotes 2 piece pole with joiner and includes extra bracket

Packed:
Individual Transport Packed

Kit includes: Non Lined

Matt Black Complete Kit with Short L-Brackets



Plain Ball
Matt Black – Short L-Bracket

Also available in:
Long L-Brackets
Complete kits
 Length 110mm



End Cap
Matt Black – Short L-Bracket

Also available in:
Long L-Brackets
Complete kits
 Length 110mm

Contract 28mm Complete Kit Sizes Available:

- 1.20m (3'11")
- 1.50m (4'11")
- 2.00m (6'7")
- 2.40m*(7'10")
- 3.00m*(9'10")
- 4.00m*(13'1")

* Denotes 2 piece pole with joiner and includes extra bracket

Packed:
Individual Transport Packed

Kit includes: 85mm Non Lined

Matt Black Complete Kit with Short Ceiling Brackets



Plain Ball
Matt Black – Short Ceiling Bracket

Also available in:
Adjustable
K-Bracket
Complete kits



End Cap
Matt Black – Short Ceiling Bracket

Also available in:
Adjustable
K-Bracket
Complete kits

Contract 28mm Complete Kit Sizes Available:

- 1.20m (3'11")
- 1.50m (4'11")
- 2.00m (6'7")
- 2.40m*(7'10")
- 3.00m*(9'10")
- 4.00m*(13'1")

* Denotes 2 piece pole with joiner and includes extra bracket

Packed:
Individual Transport Packed

Kit includes: Non Lined

Matt Black Complete Kit with Extendable Cup Brackets



Plain Ball
Matt Black – Extendable Cup Bracket



End Cap
Matt Black – Extendable Cup Bracket

Contract 28mm Complete Kit Sizes Available:

- 1.20m (3'11")
- 1.50m (4'11")
- 2.00m (6'7")
- 2.40m*(7'10")
- 3.00m*(9'10")
- 4.00m*(13'1")

* Denotes 2 piece pole with joiner and includes extra bracket

Packed:
Individual Transport Packed

Kit includes: Non Lined

DISCLAIMER: Whilst every effort has been made to ensure colour accuracy, due to the limitations of colour printing, please refer to product samples for colour matching. Product dimensions are for guidance only and may differ – please confirm details at time of ordering.

Contract 28mm – Matt Black Eyelet Pole Kits

Matt Black Eyelet Pole Kit with Contemporary Brackets



Plain Ball
Matt Black – Contemporary Bracket



End Cap
Matt Black – Contemporary Bracket

Contract 28mm Eyelet Pole Kit Sizes Available:
1.20m (3'11") 1.50m (4'11") 2.00m (6'7")
2.40m*(7'10") 3.00m*(9'10") 4.00m*(13'1")

* Denotes 2 piece pole with joiner and includes extra bracket

Packed:
Individual 
Transport Packed

Kit includes: 

Matching Eyelets:
See this Catalogue p206-210 

Matt Black Eyelet Pole Kit with Long L-Brackets



Plain Ball
Matt Black – Long L-Bracket



End Cap
Matt Black – Long L-Bracket

Contract 28mm Eyelet Pole Kit Sizes Available:
1.20m (3'11") 1.50m (4'11") 2.00m (6'7")
2.40m*(7'10") 3.00m*(9'10") 4.00m*(13'1")

* Denotes 2 piece pole with joiner and includes extra bracket

Packed:
Individual 
Transport Packed

Kit includes:  110mm

Matching Eyelets:
See this Catalogue p206-210 

Matt Black Eyelet Pole Kit with Adjustable K-Brackets



Plain Ball
Matt Black – Adjustable K-Bracket



End Cap
Matt Black – Adjustable K-Bracket

Contract 28mm Eyelet Pole Kit Sizes Available:
1.20m (3'11") 1.50m (4'11") 2.00m (6'7")
2.40m*(7'10") 3.00m*(9'10") 4.00m*(13'1")

* Denotes 2 piece pole with joiner and includes extra bracket

Packed:
Individual 
Transport Packed

Kit includes: 

Matching Eyelets:
See this Catalogue p206-210 

DISCLAIMER: Whilst every effort has been made to ensure colour accuracy, due to the limitations of colour printing, please refer to product samples for colour matching. Product dimensions are for guidance only and may differ – please confirm details at time of ordering.



Contract 28mm – Polished Silver Complete Kits

Polished Silver Complete Kit with Contemporary Brackets



Plain Ball
Polished Silver – Contemporary Bracket



End Cap
Polished Silver – Contemporary Bracket

Contract 28mm Complete Kit Sizes Available:

1.20m (3'11") 1.50m (4'11") 2.00m (6'7")
2.40m*(7'10") 3.00m*(9'10") 4.00m*(13'1")

* Denotes 2 piece pole with joiner and includes extra bracket

Packed:
Individual Transport Packed

Kit includes:

Polished Silver Complete Kit with Short L-Brackets



Plain Ball
Polished Silver – Short L-Bracket

Also available in:
Long L-Brackets
Complete kits
 Length 110mm



End Cap
Polished Silver – Short L-Bracket

Also available in:
Long L-Brackets
Complete kits
 Length 110mm

Contract 28mm Complete Kit Sizes Available:

1.20m (3'11") 1.50m (4'11") 2.00m (6'7")
2.40m*(7'10") 3.00m*(9'10") 4.00m*(13'1")

* Denotes 2 piece pole with joiner and includes extra bracket

Packed:
Individual Transport Packed

Kit includes: 85mm

Polished Silver Complete Kit with Adjustable K-Brackets



Plain Ball
Polished Silver – Adjustable K-Bracket



End Cap
Polished Silver – Adjustable K-Bracket

Contract 28mm Complete Kit Sizes Available:

1.20m (3'11") 1.50m (4'11") 2.00m (6'7")
2.40m*(7'10") 3.00m*(9'10") 4.00m*(13'1")

* Denotes 2 piece pole with joiner and includes extra bracket

Packed:
Individual Transport Packed

Kit includes:

Polished Silver Complete Kit with Extendable Cup Brackets



Plain Ball
Polished Silver – Extendable Cup Bracket



End Cap
Polished Silver – Extendable Cup Bracket

Contract 28mm Complete Kit Sizes Available:

1.20m (3'11") 1.50m (4'11") 2.00m (6'7")
2.40m*(7'10") 3.00m*(9'10") 4.00m*(13'1")

* Denotes 2 piece pole with joiner and includes extra bracket

Packed:
Individual Transport Packed

Kit includes:

DISCLAIMER: Whilst every effort has been made to ensure colour accuracy, due to the limitations of colour printing, please refer to product samples for colour matching. Product dimensions are for guidance only and may differ – please confirm details at time of ordering.

Contract 28mm – Polished Silver Eyelet Pole Kits

Polished Silver Eyelet Pole Kit with Contemporary Brackets



Plain Ball
Polished Silver – Contemporary Bracket



End Cap
Polished Silver – Contemporary Bracket

Contract 28mm Eyelet Pole Kit Sizes Available:
1.20m (3'11") 1.50m (4'11") 2.00m (6'7")
2.40m*(7'10") 3.00m*(9'10") 4.00m*(13'1")

* Denotes 2 piece pole with joiner and includes extra bracket

Packed:
Individual 
Transport Packed

Kit includes: 

Matching Eyelets:
See this Catalogue p206-210 

Polished Silver Eyelet Pole Kit with Long L-Brackets



Plain Ball
Polished Silver – Long L-Bracket



End Cap
Polished Silver – Long L-Bracket

Contract 28mm Eyelet Pole Kit Sizes Available:
1.20m (3'11") 1.50m (4'11") 2.00m (6'7")
2.40m*(7'10") 3.00m*(9'10") 4.00m*(13'1")

* Denotes 2 piece pole with joiner and includes extra bracket

Packed:
Individual 
Transport Packed

Kit includes:  110mm

Matching Eyelets:
See this Catalogue p206-210 

Polished Silver Eyelet Pole Kit with Adjustable K- Brackets



Plain Ball
Polished Silver – Adjustable K-Bracket



End Cap
Polished Silver – Adjustable K-Bracket

Contract 28mm Eyelet Pole Kit Sizes Available:
1.20m (3'11") 1.50m (4'11") 2.00m (6'7")
2.40m*(7'10") 3.00m*(9'10") 4.00m*(13'1")

* Denotes 2 piece pole with joiner and includes extra bracket

Packed:
Individual 
Transport Packed

Kit includes: 

Matching Eyelets:
See this Catalogue p206-210 

DISCLAIMER: Whilst every effort has been made to ensure colour accuracy, due to the limitations of colour printing, please refer to product samples for colour matching. Product dimensions are for guidance only and may differ – please confirm details at time of ordering.

Contract 28mm – Black Nickel Complete Kits

Black Nickel Complete Kit with Contemporary Brackets



Plain Ball
Black Nickel – Contemporary Bracket



End Cap
Black Nickel – Contemporary Bracket

Contract 28mm Complete Kit Sizes Available:

1.20m (3'11") 1.50m (4'11") 2.00m (6'7")
2.40m*(7'10") 3.00m*(9'10") 4.00m*(13'1")

* Denotes 2 piece pole with joiner and includes extra bracket

Packed:
Individual Transport Packed

Kit includes: Non Lined

Black Nickel Complete Kit with Short L-Brackets



Plain Ball
Black Nickel – Short L-Bracket



End Cap
Black Nickel – Short L-Bracket

Contract 28mm Complete Kit Sizes Available:

1.20m (3'11") 1.50m (4'11") 2.00m (6'7")
2.40m*(7'10") 3.00m*(9'10") 4.00m*(13'1")

* Denotes 2 piece pole with joiner and includes extra bracket

Packed:
Individual Transport Packed

Kit includes: 85mm Non Lined

Black Nickel Complete Kit with Adjustable K-Brackets



Plain Ball
Black Nickel – Adjustable K-Bracket



End Cap
Black Nickel – Adjustable K-Bracket

Contract 28mm Complete Kit Sizes Available:

1.20m (3'11") 1.50m (4'11") 2.00m (6'7")
2.40m*(7'10") 3.00m*(9'10") 4.00m*(13'1")

* Denotes 2 piece pole with joiner and includes extra bracket

Packed:
Individual Transport Packed

Kit includes: Non Lined

DISCLAIMER: Whilst every effort has been made to ensure colour accuracy, due to the limitations of colour printing, please refer to product samples for colour matching. Product dimensions are for guidance only and may differ – please confirm details at time of ordering.

Contract 28mm – Black Nickel Eyelet Pole Kits

Black Nickel Eyelet Pole Kit with Contemporary Brackets





Plain Ball
Black Nickel – Contemporary Bracket



End Cap
Black Nickel – Contemporary Bracket

Contract 28mm Eyelet Pole Kit Sizes Available:
1.20m (3'11") 1.50m (4'11") 2.00m (6'7")
2.40m*(7'10") 3.00m*(9'10") 4.00m*(13'1")

* Denotes 2 piece pole with joiner and includes extra bracket

Packed:
Individual 
Transport Packed 

Kit includes: 

Matching Eyelets:
See this Catalogue p206–210 

Black Nickel Eyelet Pole Kit with Short L-Brackets



Plain Ball
Black Nickel – Short L-Bracket



End Cap
Black Nickel – Short L-Bracket

Contract 28mm Eyelet Pole Kit Sizes Available:
1.20m (3'11") 1.50m (4'11") 2.00m (6'7")
2.40m*(7'10") 3.00m*(9'10") 4.00m*(13'1")

* Denotes 2 piece pole with joiner and includes extra bracket

Packed:
Individual 
Transport Packed 

Kit includes:  110mm

Matching Eyelets:
See this Catalogue p206–210 

Black Nickel Eyelet Pole Kit with Adjustable K-Brackets





Plain Ball
Black Nickel – Adjustable K-Bracket



End Cap
Black Nickel – Adjustable K-Bracket

Contract 28mm Eyelet Pole Kit Sizes Available:
1.20m (3'11") 1.50m (4'11") 2.00m (6'7")
2.40m*(7'10") 3.00m*(9'10") 4.00m*(13'1")

* Denotes 2 piece pole with joiner and includes extra bracket

Packed:
Individual 
Transport Packed 

Kit includes: 

Matching Eyelets:
See this Catalogue p206–210 

DISCLAIMER: Whilst every effort has been made to ensure colour accuracy, due to the limitations of colour printing, please refer to product samples for colour matching. Product dimensions are for guidance only and may differ – please confirm details at time of ordering.

Quick-Fit Range

Contract 28 Components

new

Our Quick-Fit Contract range of specially designed 28mm components are ideal for hard-to-reach areas or to speed up high volume installations.

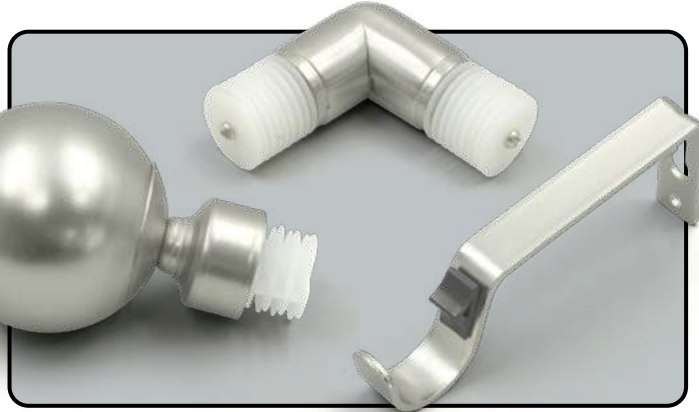

NO GRUB SCREWS
NO AWKWARD ALLEN KEYS

Pole Diameter:
28mm



Quick-Fit Ball Finial
 Simply push the finial into the end of your pole, leaving a neat collar finish.

Quick-Fit L-Bracket
 Push your pole into position from above, the bracket clicks to hold it firmly in place.

Colour finishes available:

- BLACK NICKEL
- ANTIQUÉ BRASS
- POLISHED SILVER
- BRUSHED NICKEL
- MATT BLACK

Quick-Fit Contract 28mm Components

 <p>Quick-Fit Ball Finial Adds 75mm to pole length</p>	 <p>Quick-Fit L-Bracket 11cm to centre-of-pole projection</p>	 <p>Quick-Fit Pole Joiner Multiangle Function</p>	 <p>Nylon-lined Rings For quieter running</p>	 <p>Single Length Poles 1.2, 1.5, 2.0, 2.4 & 3.0m</p>
--	---	--	---	---

 <p>This curtain pole is suitable for medium-to-heavy weight curtains</p>	<p>Available in component form only. Fully compatible with Contract 28 Range</p>	 <p>Kits/components are delivered in transport packaging</p>	 <p>Available in contract components for large jobs</p>	 <p>Time saving solution</p>	 <p>Ideal for fitting in confined spaces</p>
--	--	---	---	---	---

DISCLAIMER: Whilst every effort has been made to ensure colour accuracy, due to the limitations of colour printing, please refer to product samples for colour matching. Product dimensions are for guidance only and may differ – please confirm details at time of ordering.

Contract 29 Range

Stainless Steel Poles

Contract 29mm Stainless Steel Curtain Poles are available in loose contract form only with a variety of bracket options.

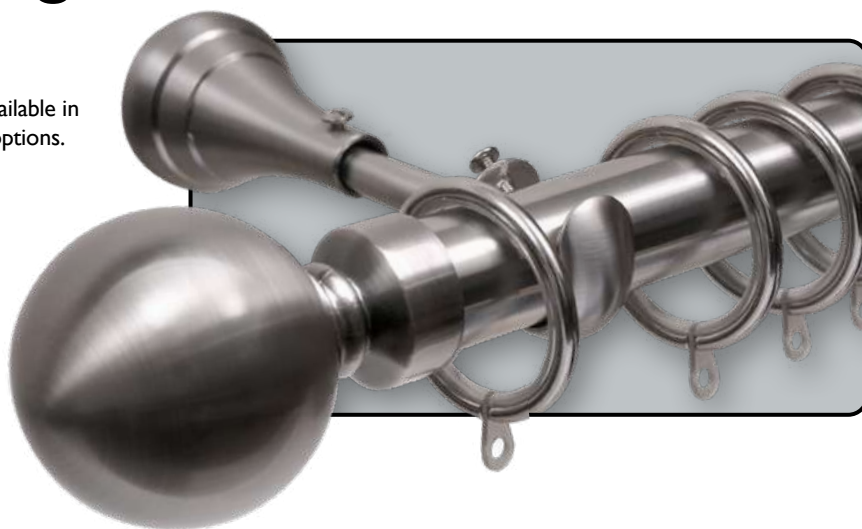

Contract 29 with Ceiling Bracket and End Cap



Contract 29 with Contemporary Brackets and Plain Ball Finial



Contract 29mm Stainless Steel Eyelet Pole Kits are also available special order – please discuss with our Sales Team.

NOTE: Short L-Bracket Kits are NOT available for Eyelet Pole Kits.

Pole Diameter:
29mm

For Eyelets
see this
Catalogue
p206–210



Colour finishes available:

STAINLESS STEEL

Contract 29 Stainless Steel Kit Components

Component	Pole Kit Sizes						
	1.20m (3'11")	1.60m (5'3")	2.00m (6'7")	2.40m* (7'10")	3.20m* (10'6")	4.00m* (13'1")	5.00m* (16'5")
Pole	1 x 1.2m	1 x 1.6m	1 x 2m	2 x 1.2m	2 x 1.6m	2 x 2m	2 x 2.5m
Brackets	2	2	2	3	3	3	3
Finials	2	2	2	2	2	2	2
Non-Lined Rings	12	16	20	24	32	40	50

NOTE: Standard Kits are supplied with non-lined Rings

*Denotes 2 piece pole with joiner. All kits include relevant fittings and instructions.



This curtain pole is suitable for medium-to-heavy weight curtains



Suitable for straight runs. Bay window option available.



Kits/components are delivered in transport packaging



Available in contract components for large jobs



Available in kit form for simple ordering



Poles available made-to-measure

DISCLAIMER: Whilst every effort has been made to ensure colour accuracy, due to the limitations of colour printing, please refer to product samples for colour matching. Product dimensions are for guidance only and may differ – please confirm details at time of ordering.

Contract 29mm Components

Contract 29mm Finials



Plain Ball Finial
Packed: Individually

End Cap

Contract 29mm Poles & Joiners

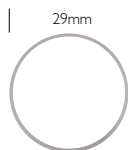

5m Length Pole

Packed: Individually



29mm Pole Joiner



Multiangle
29mm Pole Joiner

Contract 29mm Metal Rings

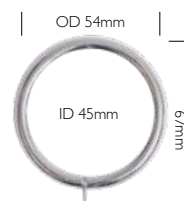

Non-Lined Ring†

Packed: Individually

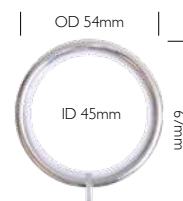

Ring with Nylon Insert
Ensures Quieter Running

†Supplied in Kits as standard

Contract 29mm Bracket Options



Contemporary Bracket

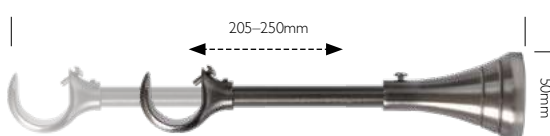

Extendable Cup Bracket

This bracket can be shortened. Short version also available.

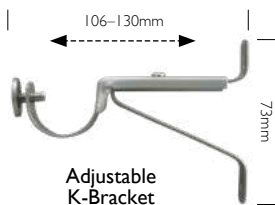

Adjustable
K-Bracket



Short
L-Bracket*



Recess Bracket

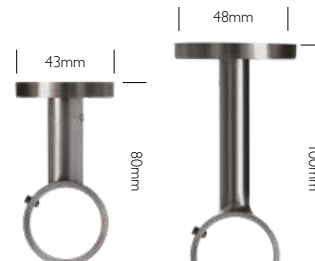

Short Ceiling
Bracket

Long Ceiling
Bracket

Contract 29mm – Stainless Steel Complete Kits

Stainless Steel Complete Kit with Contemporary Brackets



Plain Ball
Stainless Steel – Contemporary Bracket



End Cap
Stainless Steel – Contemporary Bracket

Contract 29mm Complete Kit Sizes Available:

1.20m (3'11") 1.60m (5'3") 2.00m (6'7") 2.40m*(7'10")

3.20m*(10'6") 4.00m*(13'1") 5.00m*(15'9")

* Denotes 2 piece pole with joiner and includes extra bracket

Packed:

Individual Transport Packed

Kit includes:



Stainless Steel Complete Kit with Short L-Brackets



Plain Ball
Stainless Steel – Short L-Bracket



End Cap
Stainless Steel – Short L-Bracket

Contract 29mm Complete Kit Sizes Available:

1.20m (3'11") 1.60m (5'3") 2.00m (6'7") 2.40m*(7'10")

3.20m*(10'6") 4.00m*(13'1") 5.00m*(15'9")

* Denotes 2 piece pole with joiner and includes extra bracket

Packed:

Individual Transport Packed

Kit includes:



DISCLAIMER: Whilst every effort has been made to ensure colour accuracy, due to the limitations of colour printing, please refer to product samples for colour matching. Product dimensions are for guidance only and may differ – please confirm details at time of ordering.

Contract 29mm – Stainless Steel Complete Kits

Stainless Steel Complete Kit with Adjustable K-Brackets



Plain Ball
Stainless Steel – Adjustable K-Bracket



End Cap
Stainless Steel – Adjustable K-Bracket

Contract 29mm Complete Kit Sizes Available:

1.20m (3'11") 1.60m (5'3") 2.00m (6'7") 2.40m*(7'10")
3.20m*(10'6") 4.00m*(13'1") 5.00m*(15'9")

* Denotes 2 piece pole with joiner and includes extra bracket

Packed:
Individual Transport Packed

Kit includes:



Stainless Steel Complete Kit with Short Ceiling Brackets



Plain Ball
Stainless Steel – Short Ceiling Bracket



End Cap
Stainless Steel – Short Ceiling Bracket

Contract 29mm Complete Kit Sizes Available:

1.20m (3'11") 1.60m (5'3") 2.00m (6'7") 2.40m*(7'10")
3.20m*(10'6") 4.00m*(13'1") 5.00m*(15'9")

* Denotes 2 piece pole with joiner and includes extra bracket

Packed:
Individual Transport Packed

Kit includes:



Stainless Steel Complete Kit with Extendable Cup Brackets



Plain Ball
Stainless Steel – Extendable Cup Bracket



End Cap
Stainless Steel – Extendable Cup Bracket

Contract 29mm Complete Kit Sizes Available:

1.20m (3'11") 1.60m (5'3") 2.00m (6'7") 2.40m*(7'10")
3.20m*(10'6") 4.00m*(13'1") 5.00m*(15'9")

* Denotes 2 piece pole with joiner and includes extra bracket

Packed:
Individual Transport Packed

Kit includes:



NOTE: Contract 29 Stainless Steel Kits are also available to special order – please discuss with our Sales Team.

*Eyelet Kits do not work with Short L-Brackets.

DISCLAIMER: Whilst every effort has been made to ensure colour accuracy, due to the limitations of colour printing, please refer to product samples for colour matching. Product dimensions are for guidance only and may differ – please confirm details at time of ordering.

Contract 19 Range

Stainless Steel Poles

Contract 19mm Curtain Poles are available in loose contract form or as complete kits with a variety of bracket options.

Pole set include Contemporary Brackets and a choice of two finial designs – Plain Ball or End Cap.



Contract 19 with End Cap

NOTE: Standard Kits include non-lined Rings



Contract 19 with Plain Ball Finial

NOTE: Standard Kits include non-lined Rings



Eyelet Pole Kits also available

Pole Diameter: 19mm



For Eyelets see this Catalogue p206-210

Colour finishes available:
STAINLESS STEEL

Contract 19 Stainless Steel Kit Components

Component	Pole Kit Sizes						
	1.20m (3'11")	1.60m (5'3")	2.00m (6'7")	2.40m* (7'10")	3.20m* (10'6")	4.00m* (13'1")	5.00m* (16'5")
Pole	1 x 1.2m	1 x 1.6m	1 x 2m	2 x 1.2m	2 x 1.6m	2 x 2m	2 x 2.5m
Brackets	2	2	2	3	3	3	3
Finials	2	2	2	2	2	2	2
Non-Lined Rings	12	16	20	24	32	40	50

*Denotes 2 piece pole with joiner and includes extra bracket All kits include relevant fittings and instructions.

<p>This curtain pole is suitable for medium-to-heavy weight curtains</p>	<p>Suitable for straight runs ONLY</p>	<p>Kits/components are delivered in transport packaging</p>	<p>Available in contract components for large jobs</p>	<p>Available in kit form for simple ordering</p>	<p>Poles available made-to-measure</p>
--	--	---	--	--	--

DISCLAIMER: Whilst every effort has been made to ensure colour accuracy, due to the limitations of colour printing, please refer to product samples for colour matching. Product dimensions are for guidance only and may differ – please confirm details at time of ordering.

Contract 19mm Components

Contract 19mm Finials



Plain Ball Finial

End Cap

Packed: Individually or part of a complete kit

Contract 19mm Poles and Joiners



5m Single Length Poles

Packed: Individually or part of a complete kit



Pole Joiner

Packed: Individually

Contract 19mm Brackets

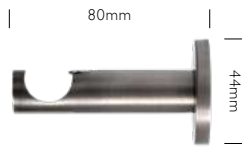

Contemporary Bracket

Packed: Individually or part of a complete kit



Ceiling Bracket

Contract 19mm Rings



Non-Lined Metal Ring

Packed: Individually or part of a complete kit

Contract 19mm – Stainless Steel Complete Kits

Stainless Steel Complete Kit with Contemporary Brackets



Plain Ball with Collar
Stainless Steel – Contemporary Bracket



End Cap
Stainless Steel – Contemporary Bracket

Contract 19mm Complete Kit Sizes Available:

1.20m (3'11") 1.60m (5'3") 2.00m (6'7") 2.40m*(7'10")
3.20m*(10'6") 4.00m*(13'1") 5.00m*(16'5")

* Denotes 2 piece pole with joiner and includes extra bracket

Packed: Individual 
Transport Packed

Kit includes:



Contract 19mm – Stainless Steel Eyelet Pole Kits

Stainless Steel Eyelet Pole Kit with Contemporary Brackets



Plain Ball with Collar
Stainless Steel – Contemporary Bracket



End Cap
Stainless Steel – Contemporary Bracket

Contract 19mm Eyelet Pole Kit Sizes Available:

1.20m (3'11") 1.60m (5'3") 2.00m (6'7") 2.40m*(7'10")
3.20m*(10'6") 4.00m*(13'1") 5.00m*(16'5")

* Denotes 2 piece pole with joiner and includes extra bracket

Packed: Individual 
Transport Packed

Kit includes:



Matching Eyelets: See this Catalogue p206-210 

NOTE: Contract 19mm Stainless Steel Pole Kits with Ceiling Brackets are also available special order – please discuss with our Sales Team.

DISCLAIMER: Whilst every effort has been made to ensure colour accuracy, due to the limitations of colour printing, please refer to product samples for colour matching. Product dimensions are for guidance only and may differ – please confirm details at time of ordering.

Draw Rods

Metal Draw Rods



Contemporary Steel Draw Rod

Sizes: 100cm, 125cm, 150cm, 200cm[†]

[†]200cm is a special order product and may have a longer lead time

*Titanium Draw Rods coordinate very well with all Brushed Nickel & Stainless Steel Pole Kits.



Clip Detail

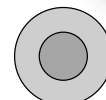

14mm Handle | 7mm Body



Plastic Coated Steel Draw Rod

Sizes: 50cm, 75cm, 100cm, 125cm, 150cm



Clip Detail



10mm Handle | 5mm Body



Style Aluminium Draw Rod

Sizes: 75cm, 100cm, 125cm, 150cm

Handle Detail



9mm Hollow Rod

Plastic Draw Rods



Luxury Clear Acrylic Draw Rod

Sizes: 75cm, 100cm, 125cm, 150cm, 200cm



Clip Detail



12mm Rod



Sizes: 75cm, 100cm, 125cm, 150cm

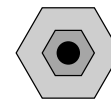

15mm Handle | 8mm Body



Sizes: 50cm, 75cm, 100cm, 125cm, 150cm

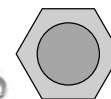

15mm Handle | 9mm Body

DISCLAIMER: Whilst every effort has been made to ensure colour accuracy, due to the limitations of colour printing, please refer to product samples for colour matching. Product dimensions are for guidance only and may differ – please confirm details at time of ordering.



RENAISSANCE



PLASTIC CURTAIN TRACKS



PLASTIC CURTAIN TRACKS



RENAISSANCE

TEL 0113 250 4499

• EMAIL SALES@RCA-UK.COM

• VISIT RCA-UK.COM

Jetrack uPVC Curtain Track

Jetrack Flexible Track
Perfect for Bay Windows

Jetrack is a truly flexible track – it can be bent to a 90° angle and reverse bent and it's gliders will still glide smoothly – making it a perfect solution for Bay Windows. It also features an advanced end stop design to increase 'Black out' conditions.

Suitable for domestic, contract and commercial situations for light/medium weight curtains, the easy-glide super white track can be easily joined and wall or ceiling fixed.

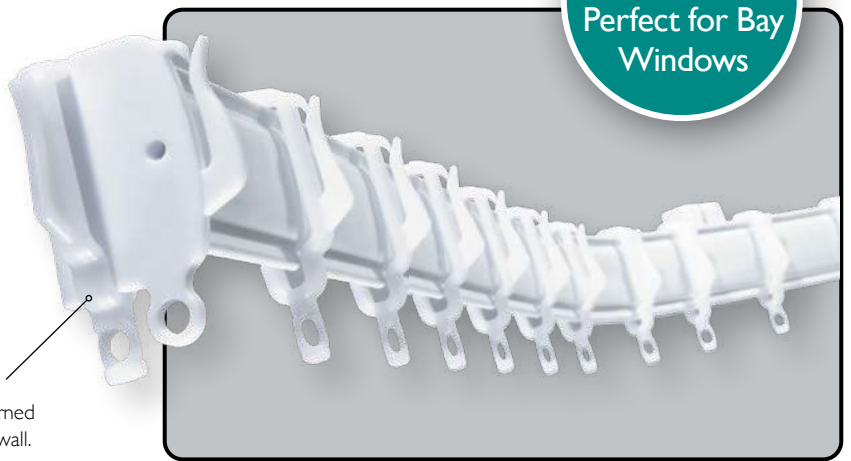

A glider clips onto the end stops for curtains to be returned completely to the wall.



Jetrack Track
Can be bent to right angles or reverse bent and the gliders will still glide smoothly.

Gliders are also UV resistant so they won't go brittle in the sunlight

Jetrack End Stops
Allows curtains to be returned to the wall preventing unwanted light and draughts and providing a neat, complete finished touch to your curtains. A glider clips onto the end stops for curtains to be returned completely to the wall.

Jetrack Gliders
Can be added to track after fitting of product. Acetal glider is self-lubricating and friction resistant ensuring an effortless opening and closing of the curtains. The gliders also designed to go round smoothly around 90° bends. Also includes locking clip to avoid accidental removal of the curtain tape.

Jetrack uPVC Curtain Track & Fitting Kits

Straight Length Track	Fitting Kit*
2m (6'6") Code: 12PJTR2-	2m (6'6") Code: 12PJFI2-
3m (9'10") Code: 12PJTR3-	3m (9'10") Code: 12PJFI3-
5m (16'4") Code: 12PJTR5-	5m (16'4") Code: 12PJFI5-

Also Available: 30m (98'5") Track Coil Code: 12PJTR30

Jetrack Accessories

<p>Jetrack End Stops Code: 12PJESL2 Packed: Loose 50 pairs</p>	<p>Jetrack Brackets Code: 12PJBRC- Simple 'Click-on' wall or ceiling fix leverlock brackets. Packed: Loose 100</p>
<p>Jetrack Gliders Code: 12PJGLK- Packed: Loose 1000</p>	<p>Jetrack Joining Bridge Code: 12PJJOC- Packed: Loose 100</p>

<p>This curtain track is suitable for medium weight curtains</p>	<p>Suitable for straight runs and can also be bent</p>	<p>Kits/components are delivered in transport or retail packaging</p>	<p>Available in contract components for large jobs</p>	<p>Available in kit form for simple ordering</p>	<p>Not available made-to-measure</p>
--	--	---	--	--	--------------------------------------

DISCLAIMER: Whilst every effort has been made to ensure colour accuracy, due to the limitations of colour printing, please refer to product samples for colour matching. Product dimensions are for guidance only and may differ – please confirm details at time of ordering.



RENAISSANCE

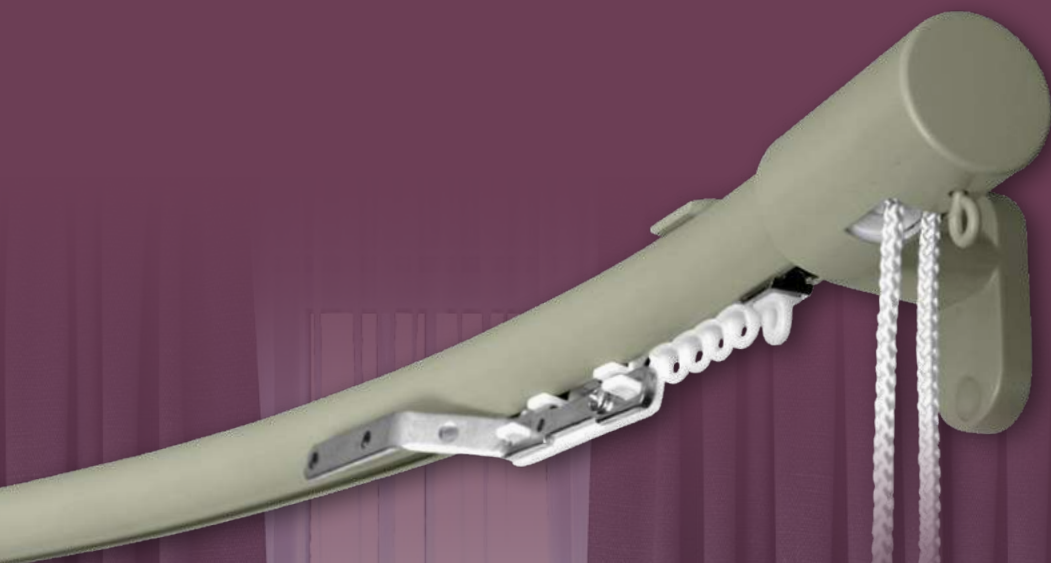

METAL CURTAIN TRACKS



METAL CURTAIN TRACKS



RENAISSANCE

TEL 0113 250 4499

• EMAIL SALES@RCA-UK.COM

• VISIT RCA-UK.COM

Distinction 28 Round

Distinction curtain tracks are a blend of elegance and functionality allowing effortless operation in the trickiest of situations.

Bay windows or wide windows/doors were a 'window-dressing' nightmare until the concept of tracked poles arrived. The idea is simple – the brackets are fitted above the track meaning there is none of the traditional conflict with curtain rings obstructed by them. The Distinction range allows even a single curtain to traverse a bay window or cover over a patio door without being restricted.

The Distinction 28 Round is the most popular of the Distinction family. The clean and smart looks fit with the most contemporary decor, whilst at the same time not looking out of place in the most traditional setting, especially with the addition of the finial options.



CAN ALSO BE BENT
Distinction 28 can be custom bent – ideal for bay windows

Distinction 28 Round Corded

28mm diameter cord operated pole for medium weight curtains

- Excellent for bay windows and very large windows as the curtains do not conflict with the brackets
- Can be used with the SurgeWave® System to give a stunning, contemporary look!
- Can be corded from both sides using the intermediate pulley
- Double overlap arms mean curtains remain well-dressed when open
- Very strong wall 'T' bracket with 40mm adjustment
- Option of short, medium or long adjustable wall bracket at no extra cost
- Available in 11 colours with colour matched wall or ceiling fix brackets.
- Glider and cord channels are coated with silicone and PTFE!
- Roller wheels on overlaps to prevent jamming on bends
- Cut out in track to allow removal or addition of gliders
- Efficient nylon gliders as standard, with option of roller gliders
- Discreet Top fix bracket available
- Eyelet on the end hides unsightly cords behind curtain
- Colour matched brackets & cording sets
- 30cm radius on forward & reverse bends
- Gradual curves available
- Right or Left hand pull, or both when using the Intermediate Pulley
- Pair or single stack



SurgeWave
COMPATIBLE PRODUCT

CHILD SAFETY FIRST!

Distinction 28 Round Uncorded

28mm diameter hand drawn pole for medium-heavy weight curtains

- Excellent for bay windows & very large windows as the curtains do not conflict with the brackets
- Can be used with the SurgeWave® System to give a stunning, contemporary look!
- Very strong wall 'T' bracket with 40mm adjustment
- Option of short, medium or long adjustable wall bracket at no extra cost
- Available in 11 colours with colour matched wall or ceiling fix brackets.
- Discreet Top fix bracket available
- Efficient nylon gliders as standard, with option of rollers
- Gradual curves available
- Colour matched brackets & endcaps
- 30cm radius on forward & reverse bends
- Glider channels are coated with silicone and PTFE!
- Pair or single stack

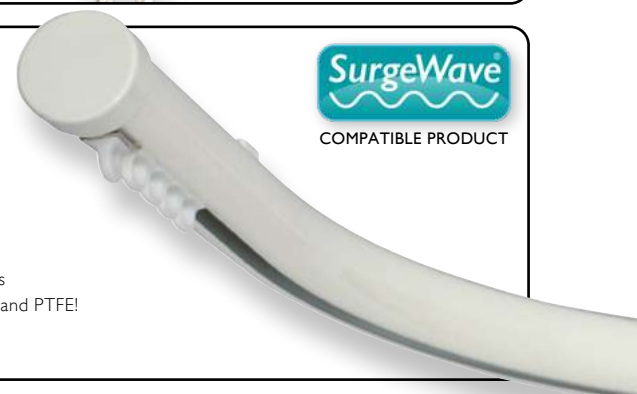

SurgeWave
COMPATIBLE PRODUCT

Distinction 28 Round Track Kit Components

NOTE: Kits are available up to the size ordered and can also be produced to your specific size.

NOTE: Kits come with 10 gliders per m unless otherwise specified

Components	Track Kit Sizes							
	1.00m (3'3")	1.50m (4'11")	2.00m (6'7")	2.50m (8'2")	3.00m* (9'10")	4.00m* (13'1")	5.00m* (16'5")	6.00m* (19'8")
Profile Track	1 x 1.00m	1 x 1.50m	1 x 2.00m	1 x 2.50m	2 x 1.50m	2 x 2.00m	2 x 2.50m	2 x 3.00m
End Caps	2	2	2	2	2	2	2	2
Gliders^	10	16	20	26	30	40	50	60
Twist End Stops	2	2	2	2	2	2	2	2
Ceiling Brackets	2	3	4	4	5	7	9	10
Wall Brackets	2	2	3	4	4	5	7	8

* Denotes 2 piece profile with joiner. All kits include fittings.

^For SurgeWave the gliders are replaced with SurgeWave Ribbon gliders

KG MEDIUM HEAVY This curtain track is suitable for medium-to-heavy weight curtains

→ ↪ Suitable for straight runs and can also be bent

Kits/components are delivered in transport packaging

Bespoke Colour option available – ask for details

Available in kit form for simple ordering

Tracks available made-to-measure

DISCLAIMER: Whilst every effort has been made to ensure colour accuracy, due to the limitations of colour printing, please refer to product samples for colour matching. Product dimensions are for guidance only and may differ – please confirm details at time of ordering

Distinction 28 Round Accessories

Distinction 28 – Corded Finials

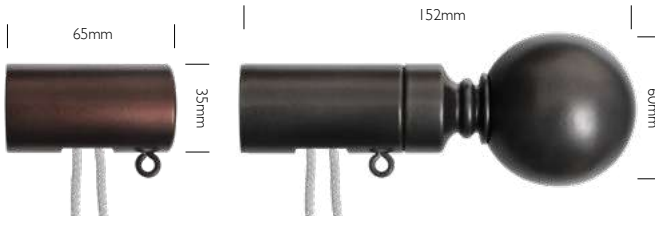

Barrel Finial – Corded
as standard with Complete Kits

Sphere Finial – Corded
Optional Extra

Distinction 28 – Uncorded Finials

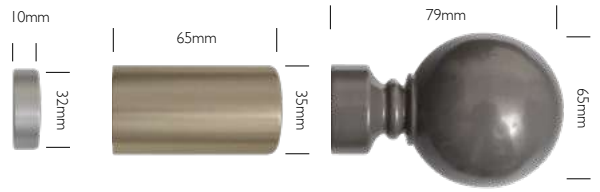

End Cap
as standard with Complete Kits

Barrel Finial
Optional Extra

Sphere Finial
Optional Extra

Distinction Brackets

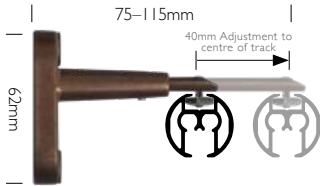

Standard Adjustable



Long Adjustable – Single Use

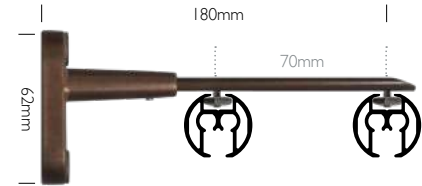

Long Adjustable – Double Use

Distinction 28 – Other Brackets*

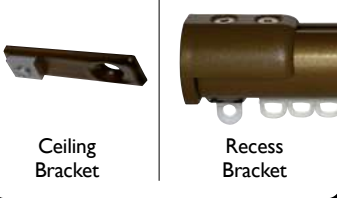

Ceiling Bracket

Recess Bracket

Distinction 28 – Connecting Solutions

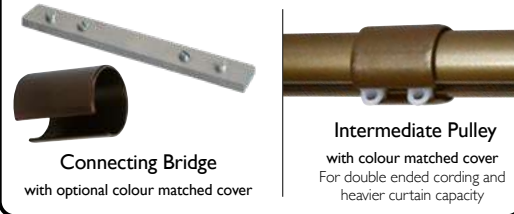

Connecting Bridge
with optional colour matched cover

Intermediate Pulley
with colour matched cover
For double ended cording and heavier curtain capacity

Distinction 28 – Glider Options



Standard Glider

Roller Glider

SurgeWave®
Ribbon Gliders†

*Not compatible with finials

†Ribbon Gliders supplied as standard on all Distinction SurgeWave Kits

Distinction 28 Round Complete Kits

Made-to-measure kits include Track, Brackets, Gliders, End Caps/End Stops. An essential time saver for the professional fitter – see overleaf for details.

Distinction Range Price Group 1 – Standard Finishes

SILVER SHEEN

WHITE SHEEN

BLACK SHEEN

Distinction Range Price Group 2 – Premium Finishes

STEEL SHEEN

HAMMERED
STEEL

CALIFORNIAN
GOLD

ANTIQU
BRONZE

BURNT BRONZE

PEARL BEIGE

LIGHT GREY

SHADED WHITE

Distinction Range Bespoke Colour

We can colour match to any of the well known paint brands
Please ask for full details and lead times.



Image by atlascompany on freepik



This curtain track is suitable for medium-to-heavy weight curtains

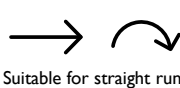

Suitable for straight runs and can also be bent



Kits/components are delivered in transport packaging



Bespoke Colour option available – ask for details



Available in kit form for simple ordering



Tracks available made-to-measure

DISCLAIMER: Whilst every effort has been made to ensure colour accuracy, due to the limitations of colour printing, please refer to product samples for colour matching. Product dimensions are for guidance only and may differ – please confirm details at time of ordering.

Distinction 28 Round Complete Kits

CAN ALSO BE BENT
Ideal for bay windows

Distinction 28 Round Corded Complete Kit



Sphere - Black Sheen



Barrel - Black Sheen



Sphere - Silver Sheen

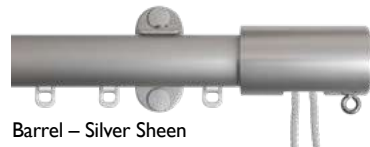

Barrel - Silver Sheen



Sphere - White Sheen



Barrel - White Sheen



Sphere - Burnt Bronze



Barrel - Burnt Bronze



Sphere - Antique Bronze



Barrel - Antique Bronze



Sphere - Californian Gold



Barrel - Californian Gold



Sphere - Hammered Steel



Barrel - Hammered Steel



Sphere - Steel Sheen



Barrel - Steel Sheen



Sphere - Pearl Beige



Barrel - Pearl Beige



Sphere - Light Grey

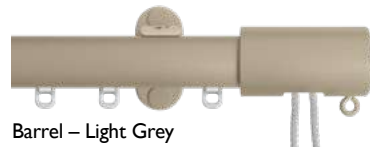

Barrel - Light Grey

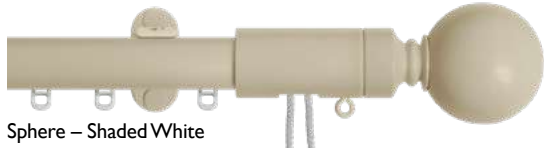

Sphere - Shaded White

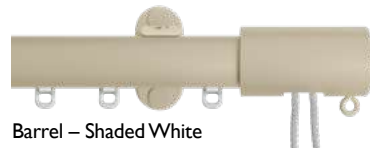

Barrel - Shaded White

Distinction 28 Complete Kit are available made-to-measure from 1.25m to 6.00m as standard in 25cm increments.

Larger sizes are available to specific request.

Packed: Individual



Transport Packed

Kit includes:



Sphere Finial is Optional Extra

Distinction 28 Round Complete Kits

CAN ALSO BE BENT
Ideal for bay windows

Distinction 28 Round Uncorded Complete Kit



Sphere – Black Sheen



Barrel – Black Sheen



End Cap – Black Sheen



Sphere – Silver Sheen



Barrel – Silver Sheen



End Cap – Silver Sheen



Sphere – White Sheen



Barrel – White Sheen



End Cap – White Sheen



Sphere – Burnt Bronze



Barrel – Burnt Bronze



End Cap – Burnt Bronze



Sphere – Antique Bronze



Barrel – Antique Bronze



End Cap – Antique Bronze



Sphere – Californian Gold



Barrel – Californian Gold



End Cap – Californian Gold



Sphere – Hammered Steel



Barrel – Hammered Steel



End Cap – Hammered Steel



Sphere – Steel Sheen



Barrel – Steel Sheen



End Cap – Steel Sheen



Sphere – Pearl Beige



Barrel – Pearl Beige



End Cap – Pearl Beige



Sphere – Light Grey



Barrel – Light Grey



End Cap – Light Grey



Sphere – Shaded White



Barrel – Shaded White



End Cap – Shaded White

Distinction 28 Complete Kit are available made-to-measure from 1.25m to 6.00m as standard in 25cm increments.

Larger sizes are available to specific request.

Packed: Individual
Transport Packed

Kit includes:



Sphere or Barrel Finials are Optional Extra

METAL CURTAIN TRACKS

DISCLAIMER: Whilst every effort has been made to ensure colour accuracy, due to the limitations of colour printing, please refer to product samples for colour matching. Product dimensions are for guidance only and may differ – please confirm details at time of ordering.

Distinction 20 Round

Distinction curtain tracks are a blend of elegance and functionality allowing effortless operation in the trickiest of situations.

Bay windows or wide windows/doors were a 'window-dressing' nightmare until the concept of tracked poles arrived. The idea is simple – the brackets are fitted above the track meaning there is none of the traditional conflict with curtain rings obstructed by them. The Distinction range allows even a single curtain to traverse a bay window or cover over a patio door without being restricted.

Distinction 20 Round allows even a single curtain to traverse a large bay window, or cover over a patio door without being restricted – perfect for the understated or minimalist look. Often this range is added to the rear of a double system carrying voiles, with the larger Distinction 28 Round at the front carrying the heavier curtains.

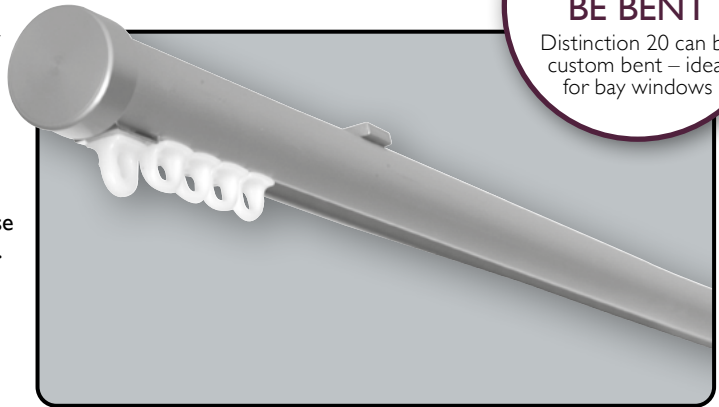

20mm diameter hand drawn pole for medium weight curtains

- Excellent for voiles on bays or large windows as the curtains do not conflict with the brackets
- Very strong wall 'T' bracket with 40mm adjustment
- Option of standard or long adjustable wall bracket at no extra cost
- Discreet Top fix bracket available
- Glider channels are coated with silicone and PTFE!
- Available in 11 colours with colour matched wall or ceiling fix brackets
- 15cm radius on forward & reverse bends
- Gradual curves available
- Colour matched brackets and endcaps
- Pair or single stack

SurgeWave
COMPATIBLE PRODUCT

Can be used as the rear pole as part of a double system as shown here with Distinction 28 Corded at the front

Distinction Range Price Group 1 – Standard Finishes

SILVER SHEEN	WHITE SHEEN	BLACK SHEEN
--------------	-------------	-------------

Distinction Range Price Group 2 – Premium Finishes

STEEL SHEEN	HAMMERED STEEL	CALIFORNIAN GOLD	ANTIQUÉ BRONZE
BURNT BRONZE	PEARL BEIGE	LIGHT GREY	SHADED WHITE

Distinction Range Bespoke Colour

We can colour match to any of the well known paint brands

Please ask for full details and lead times.

Image by atlascompany on freepik

<p>KG MEDIUM</p>	<p>This curtain track is suitable for medium weight curtains</p>	<p>Suitable for straight runs and can also be bent</p>	<p>Kits/components are delivered in transport packaging</p>	<p>Bespoke Colour option available – ask for details</p>	<p>Available in kit form for simple ordering</p>	<p>Tracks available made-to-measure</p>
-------------------------	--	--	---	--	--	---

DISCLAIMER: Whilst every effort has been made to ensure colour accuracy, due to the limitations of colour printing, please refer to product samples for colour matching. Product dimensions are for guidance only and may differ – please confirm details at time of ordering.

Distinction 20 Round Accessories

Distinction Range Brackets



Standard Adjustable



Long Adjustable – Single Use

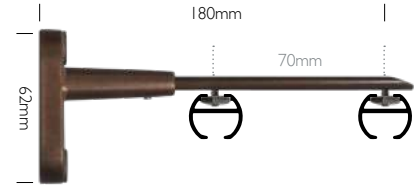

Long Adjustable – Double Use

Ceiling Bracket



Distinction 20 – Connecting Bridge



Distinction 20 – Glider Options



Standard Glider



SurgeWave® Ribbon Gliders†

†Ribbon Gliders supplied as standard on all Distinction SurgeWave Kits

Distinction 20 Round Complete Kits

Distinction 20 Round Complete Kit



Distinction 20 – Black Sheen



Distinction 20 – Antique Bronze



Distinction 20 – Pearl Beige



Distinction 20 – Silver Sheen



Distinction 20 – Californian Gold



Distinction 20 – Light Grey



Distinction 20 – White Sheen



Distinction 20 – Hammered Steel



Distinction 20 – Shaded White



Distinction 20 – Burnt Bronze



Distinction 20 – Steel Sheen

CAN ALSO BE BENT
Ideal for bay windows

Distinction 20 Complete Kit are available made-to-measure from 1.25m to 6.00m as standard in 25cm increments.

Larger sizes are available to specific request.

Packed:
Individual



Transport Packed

Kit includes:



Distinction 20 Round Track Kit Components

NOTE: Kits are available up to the size ordered and can also be produced to your specific size.

NOTE: Kits come with 10 gliders per m unless otherwise specified

Components	Track Kit Sizes							
	1.00m (3'3")	1.50m (4'11")	2.00m (6'7")	2.50m (8'2")	3.00m* (9'10")	4.00m* (13'1")	5.00m* (16'5")	6.00m* (19'8")
Profile Track	1 x 1.00m	1 x 1.50m	1 x 2.00m	1 x 2.50m	2 x 1.50m	2 x 2.00m	2 x 2.50m	2 x 3.00m
End Caps	2	2	2	2	2	2	2	2
Glider [^]	10	16	20	26	30	40	50	60
Twist End Stops	2	2	2	2	2	2	2	2
Ceiling Brackets	2	3	4	4	5	7	9	10
Wall Brackets	2	2	3	4	4	5	7	8

* Denotes 2 piece profile with joiner. All kits include fittings.

DISCLAIMER: Whilst every effort has been made to ensure colour accuracy, due to the limitations of colour printing, please refer to product samples for colour matching. Product dimensions are for guidance only and may differ – please confirm details at time of ordering.



RENAISSANCE

TEL 0113 250 4499

• EMAIL SALES@RCA-UK.COM

• VISIT RCA-UK.COM

95

Distinction 34 Flat

Distinction curtain tracks are a blend of elegance and functionality allowing effortless operation in the trickiest of situations.

Bay windows or wide windows/doors were a 'window-dressing' nightmare until the concept of tracked poles arrived. The idea is simple – the brackets are fitted above the track meaning there is none of the traditional conflict with curtain rings obstructed by them. The Distinction range allows even a single curtain to traverse a bay window or cover over a patio door without being restricted.

The Distinction 34 Flat is available to cater for the most modern taste. This is a must for contemporary decor particularly when used in conjunction with the flowing fabric waves created by SurgeWave..



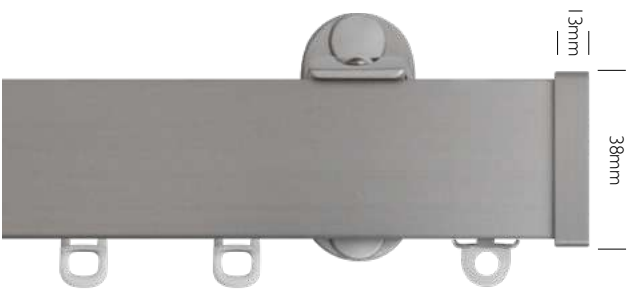



COMPATIBLE PRODUCT

34mm high Flat profile hand drawn pole for medium-heavy weight curtains

- Excellent for bay windows and very large windows as the curtains do not conflict with the brackets
- Can be used with the SurgeWave System to give a stunning, contemporary look!
- Very strong wall 'T' bracket with 40mm adjustment
- Option of standard or long adjustable wall bracket at no extra cost
- Available in 11 colours with colour matched wall or ceiling fix brackets.
- Efficient nylon gliders as standard, with option of rollers
- Glider channels are coated with silicone and PTFE!
- Discreet Top fix bracket available
- Colour matched brackets & endcaps
- 20cm radius on forward & reverse bends
- Gradual curves available
- Pair or single stack

Distinction Range Price Group 1 – Standard Finishes

SILVER SHEEN	WHITE SHEEN	BLACK SHEEN
--------------	-------------	-------------

Distinction Range Price Group 2 – Premium Finishes

STEEL SHEEN	HAMMERED STEEL	CALIFORNIAN GOLD	ANTIQUÉ BRONZE
BURNT BRONZE	PEARL BEIGE	LIGHT GREY	SHADED WHITE

Distinction Range Bespoke Colour

We can colour match to any of the well known paint brands

Please ask for full details and lead times.



 <p>This curtain track is suitable for medium-to-heavy weight curtains</p>	 <p>Suitable for straight runs and can also be bent</p>	 <p>Kits/components are delivered in transport packaging</p>	 <p>Bespoke Colour option available – ask for details</p>	 <p>Available in kit form for simple ordering</p>	 <p>Tracks available made-to-measure</p>
---	--	---	---	--	---

DISCLAIMER: Whilst every effort has been made to ensure colour accuracy, due to the limitations of colour printing, please refer to product samples for colour matching. Product dimensions are for guidance only and may differ – please confirm details at time of ordering.

Distinction 34 Flat Accessories

Distinction Range Brackets

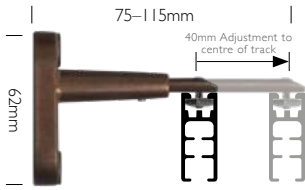

Standard Adjustable



Long Adjustable – Single Use

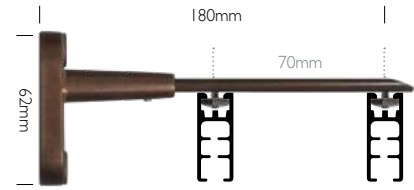

Long Adjustable – Double Use

Distinction 34 – Other Brackets



Ceiling Bracket



Recess Bracket

Distinction 34 – Connecting Bridge



Distinction 34 – Glider Options



Standard Glider



Roller Glider



SurgeWave®
Ribbon Gliders†

†Ribbon Gliders supplied as standard on all Distinction SurgeWave Kits

Distinction 34 Flat – Complete Kits

Distinction 34 Flat Complete Kit



Distinction 34 Flat – Black Sheen



Distinction 34 Flat – Antique Bronze



Distinction 34 Flat – Pearl Beige



Distinction 34 Flat – Silver Sheen



Distinction 34 Flat – Californian Gold



Distinction 34 Flat – Light Grey



Distinction 34 Flat – White Sheen



Distinction 34 Flat – Hammered Steel



Distinction 34 Flat – Shaded White



Distinction 34 Flat – Burnt Bronze



Distinction 34 Flat – Steel Sheen

Distinction 34 Flat Complete Kit are available made-to-measure from 1.25m to 6.00m as standard in 25cm increments.

Larger sizes are available to specific request.



Kit includes:



Distinction 34 Flat Track Kit Components

NOTE: Kits are available up to the size ordered and can also be produced to your specific size.

NOTE: Kits come with 10 gliders per m unless otherwise specified

Components	Track Kit Sizes							
	1.00m (3'3")	1.50m (4'11")	2.00m (6'7")	2.50m (8'2")	3.00m* (9'10")	4.00m* (13'1")	5.00m* (16'5")	6.00m* (19'8")
Profile Track	1 x 1.00m	1 x 1.50m	1 x 2.00m	1 x 2.50m	2 x 1.50m	2 x 2.00m	2 x 2.50m	2 x 3.00m
End Caps	2	2	2	2	2	2	2	2
Gliders [^]	10	16	20	26	30	40	50	60
Twist End Stops	2	2	2	2	2	2	2	2
Ceiling Brackets	2	3	4	4	5	7	9	10
Wall Brackets	2	2	3	4	4	5	7	8

* Denotes 2 piece profile with joiner. All kits include fittings.

[^]For SurgeWave the gliders are replaced with SurgeWave Ribbon gliders

DISCLAIMER: Whilst every effort has been made to ensure colour accuracy, due to the limitations of colour printing, please refer to product samples for colour matching. Product dimensions are for guidance only and may differ – please confirm details at time of ordering.



Made-to-measure
Real Wood & Faux Wood Venetian Blinds



Made-to-measure
Roller Blind Collection *

*Special Order only – please enquire.

DISCLAIMER: Whilst every effort has been made to ensure colour accuracy, due to the limitations of colour printing, please refer to product samples for colour matching. Product dimensions are for guidance only and may differ – please confirm details at time of ordering.

new Product Lines

Ocular LIT
Now available with LED Lights

new



ocular
An Eye for Beauty

new



Motiva Flat
Available now in the Core Renaissance Colours

WHITE SILVER BLACK

new



Motiva Round with Ball Finial
Corded & Uncorded now in NEW Antique

new



SurgeWave® System Tape
Now available in Black

SurgeWave
COMPATIBLE PRODUCT



Regal Pencil Pleat Tape Now in Black

new

new



Glide-Aside
Smart Home Connector Hub

Rounded Plastic Curtain Hooks
Now in Black

new



SurgeWave® Ribbon Gliders In 3 Colours

new

DISCLAIMER: Whilst every effort has been made to ensure colour accuracy, due to the limitations of colour printing, please refer to product samples for colour matching. Product dimensions are for guidance only and may differ – please confirm details at time of ordering.

The Vogue Range

An impressive minimalistic design to complement any chic decor. A brushed silver finish rail with a range of decorative finials and holdbacks, the Vogue Range is precision engineered and has a stylish presentation. Suitable for continuous curtain tracks, gliders bypass the brackets, which can also be used as stops.



No screws are visible due to unique solid magnetic cover plate



All gliders have a nylon insert for super smooth running

Nylon inserts

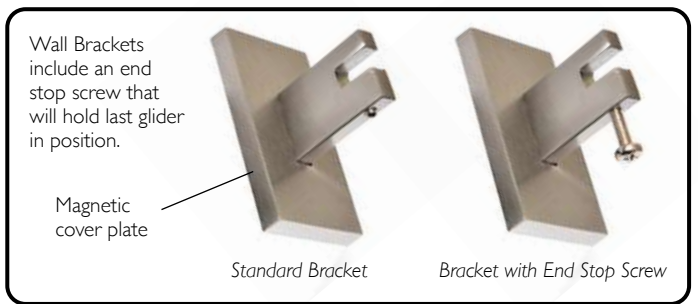

Wall Brackets include an end stop screw that will hold last glider in position.

Magnetic cover plate

Standard Bracket

Bracket with End Stop Screw

Vogue Features

- An amazing piece of engineering, easy to install and ready to impress. Superb function.
- All kits include fittings and instructions.
- Holdbacks to match your chosen finial design are also available.



Vogue Kit Components

Kit Components	Kit Sizes						
	1.00m (3'3")	1.50m (4'11")	2.00m (6'7")	2.50m (8'2")	3.00m* (9'10")	4.00m* (13'1")	5.00m* (16'5")
Pole	1 x 1.00m	1 x 1.50m	1 x 2.00m	2 x 1.25m	2 x 1.50m	2 x 2.00m	2 x 2.50m
100mm Wall Brackets	2	2	3	4	4	6	6
Finials	2	2	2	2	2	2	2
Gliders	10	16	20	26	30	40	50
Joiner					1	1	1

* Denotes 2 piece rail with joiner. All kits include relevant fittings. Single piece track kits available to special requests.



This curtain track is suitable for light-to-medium weight curtains



Suitable for straight runs ONLY



Kits/components are delivered in transport packaging



Available in contract components for large jobs



Available in kit form for simple ordering



Tracks available made-to-measure

DISCLAIMER: Whilst every effort has been made to ensure colour accuracy, due to the limitations of colour printing, please refer to product samples for colour matching. Product dimensions are for guidance only and may differ – please confirm details at time of ordering.

The Vogue Range

Vogue Rail

Vogue rail shown here with end cap

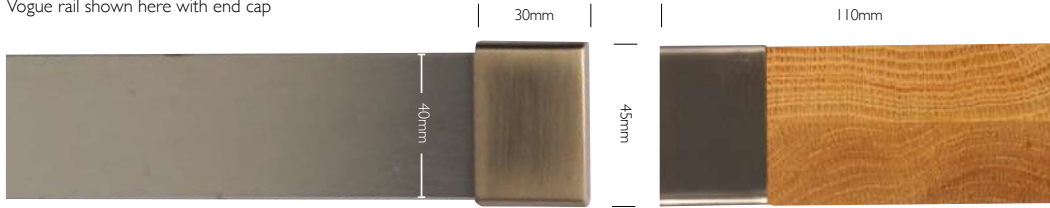

Vogue Brushed Silver Aluminium Rail
Code: 16VG500E

Finial Size: 110mm x 45mm

Size: 5m length
Packed: 10

End Cap

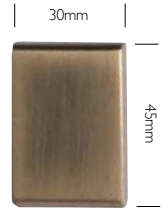

End Cap
Code: 16VGFISE

Packed: Individually

Vogue Finials



Carved Wenge
Code: 16VGFIWE



Solid Oak
Code: 16VGFOE

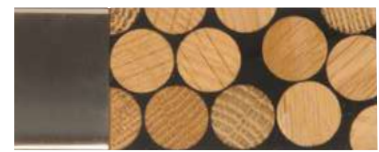

Oak Circles
Code: 16VGFIRE



Silver/Black Clouds
Code: 16VGFICE

Packed: Individually

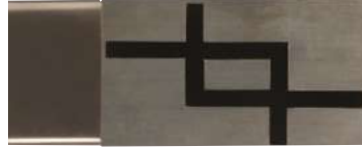

Silver/Black Interlock
Code: 16VGFIXE

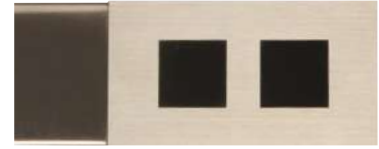

Silver/Black Squares
Code: 16VGFIQE

Vogue Accessories

Vogue Wall & Ceiling Brackets

Size shown is from back of bracket to front of track



160mm Wall Bracket †
Code: 16VGBR2E

Packed: Individually

† Includes end stop screw to hold last glider in position.



100mm Wall Bracket †
Code: 16VGBR1E

Packed: Individually



27mm from ceiling to top of track

70mm Ceiling Bracket †
Code: 16VGBRCE

Packed: Individually



Glider

Code: 16VGGLIE

Packed: Individually



How it works

All gliders have a nylon insert for super smooth running

Vogue Recess Bracket & Joiner



Recess Bracket
Code: 16VGBRRE

Joiner
Code: 16VGJOIN

Both Packed: Individually

Vogue Holdbacks



Packed: Individually

Code: 16VGHBJE

Add finial design of your choice to enhance your holdback!

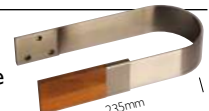

DISCLAIMER: Whilst every effort has been made to ensure colour accuracy, due to the limitations of colour printing, please refer to product samples for colour matching. Product dimensions are for guidance only and may differ – please confirm details at time of ordering.

The Vogue Range – Complete Kits

Vogue Range with 100mm OR 160mm Wall Bracket Complete Kits



Carved Wenge
100mm OR 160mm Wall Bracket

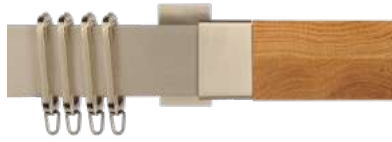

Solid Oak
100mm OR 160mm Wall Bracket



Oak Circles
100mm OR 160mm Wall Bracket



Silver/Black Clouds
100mm OR 160mm Wall Bracket



Silver/Black Interlock
100mm OR 160mm Wall Bracket



Silver/Black Squares
100mm OR 160mm Wall Bracket



End Cap
100mm OR 160mm Wall Bracket

Vogue Complete Kit Sizes Available:

- 1.00m (3'3") 1.50m (4'11") 2.00m (6'7") 2.50m* (8'2")
3.00m* (9'10") 4.00m* (13'1") 5.00m* (16'5")

* Denotes 2 piece rail with joiner. Single piece track kits available to special requests

Packed:
Individual Transport Packed

Kit includes: 100mm OR 160mm

Vogue Range with Ceiling Bracket Complete Kits



Carved Wenge
Ceiling Bracket



Solid Oak
Ceiling Bracket



Oak Circles
Ceiling Bracket



Silver/Black Clouds
Ceiling Bracket



Silver/Black Interlock
Ceiling Bracket



Silver/Black Squares
Ceiling Bracket



End Cap
Ceiling Bracket

Vogue Complete Kit Sizes Available:

- 1.00m (3'3") 1.50m (4'11") 2.00m (6'7") 2.50m* (8'2")
3.00m* (9'10") 4.00m* (13'1") 5.00m* (16'5")

* Denotes 2 piece rail with joiner. Single piece track kits available to special requests.

Packed:
Individual Transport Packed

Kit includes:

DISCLAIMER: Whilst every effort has been made to ensure colour accuracy, due to the limitations of colour printing, please refer to product samples for colour matching. Product dimensions are for guidance only and may differ – please confirm details at time of ordering.

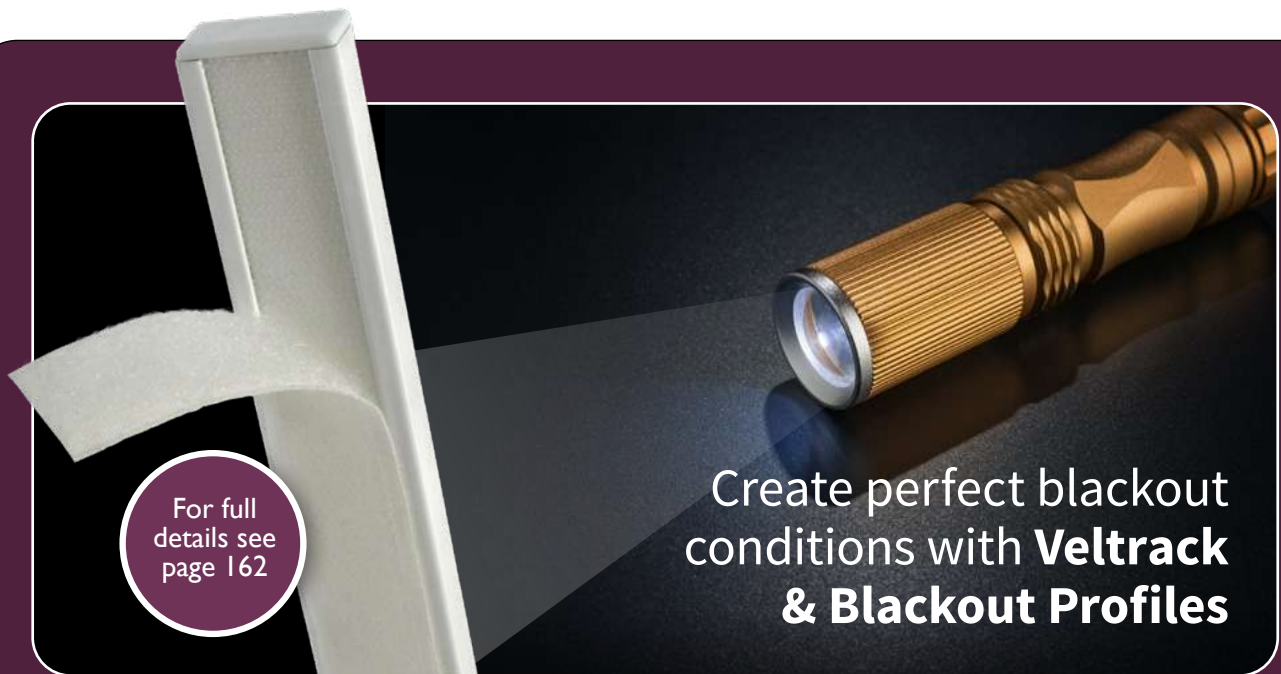

For full details see page 162

Create perfect blackout conditions with **Veltrack & Blackout Profiles**

SurgeWave® Ribbon Gliders

Our neatest 6mm SurgeWave® gliders yet!

Available in 60mm & 80mm spacing and in 3 colours:

White • Black • Grey

For full details see page 174



COMPATIBLE PRODUCT

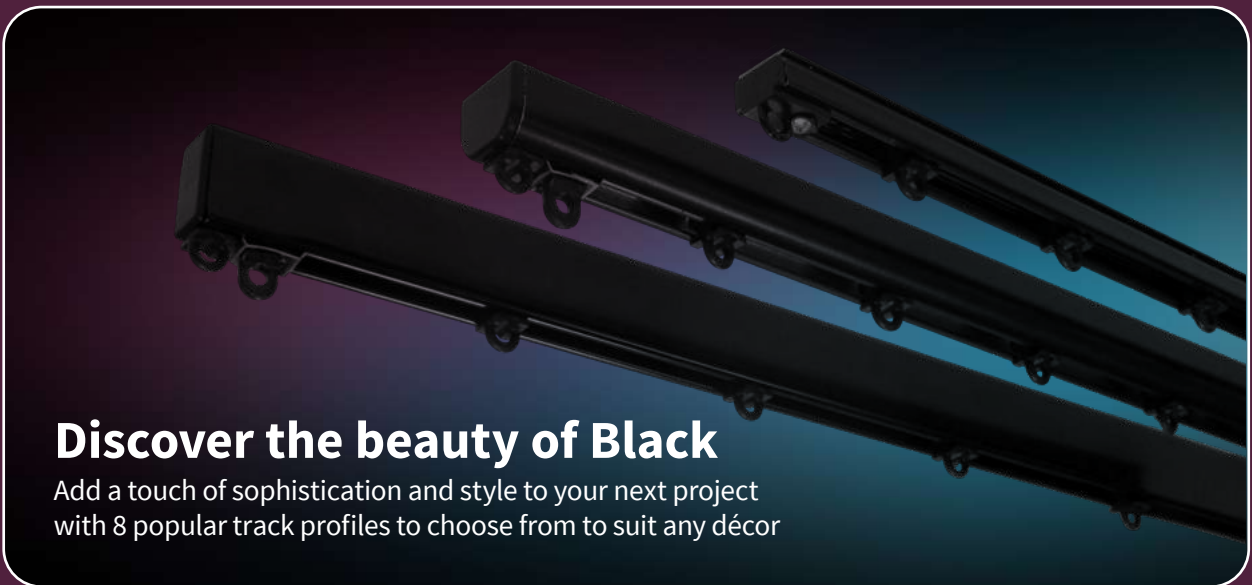

Discover the beauty of Black

Add a touch of sophistication and style to your next project with 8 popular track profiles to choose from to suit any décor

DISCLAIMER: Whilst every effort has been made to ensure colour accuracy, due to the limitations of colour printing, please refer to product samples for colour matching. Product dimensions are for guidance only and may differ – please confirm details at time of ordering.



Aluminium Curtain Tracks – 4mm Channel Profiles

Profile Comparison: 4mm Single Channel Aluminium Tracks

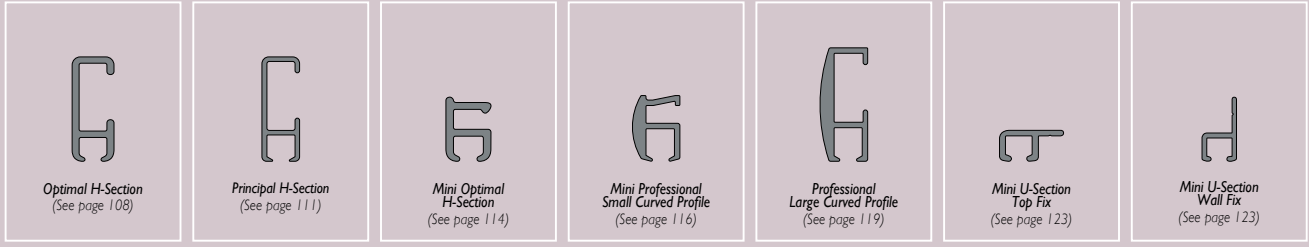

Optimal H-Section Aluminium Profile Track 4mm Channel

Size: 3m (9'10") White Code: 16OP300W
 Packed: 10 Lengths Min Qty: 10

Size: 6m (19'8") White Code: 16OP600W
 Packed: 20 Lengths Min Qty: 20
 Please see page 108 for more details and compatible components

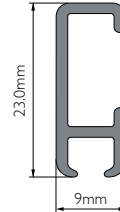

Principal H-Section Aluminium Profile Track 4mm Channel

Size: 3m (9'10") White Code: 16HS300W
 Size: 3m (9'10") Silver Code: 16HS300T
 Size: 3m (9'10") Black Code: 16HS300K
 Packed: 10 Lengths Min Qty: 10

Size: 6m (19'8") White Code: 16HS600W
 Size: 6m (9'10") Silver Code: 16HS600T
 Size: 6m (9'10") Black Code: 16HS600K
 Packed: 20 Lengths Min Qty: 20
 Please see page 111 for more details and compatible components.

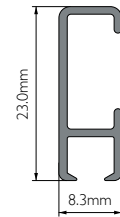

Please note at time of press some stocks of this profile are 25mm in depth. Please check details before ordering.



Mini Optimal H-Section Aluminium Profile Track 4mm Channel

Size: 3m (9'10") White Code: 16OM300W
 Packed: 10 Lengths Min Qty: 10

Size: 6m (19'8") White Code: 16OM600W
 Packed: 20 Lengths Min Qty: 20
 Please see page 114 for more details and compatible components.

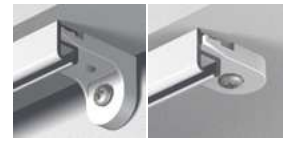
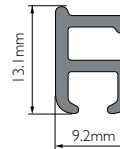

Mini Professional Small Curved Aluminium Profile Track 4mm Channel

Size: 3m (19'8") White Code: 16PM300W
 Size: 3m (9'10") Silver Code: 16PM300T
 Size: 3m (9'10") Silver Metallic Code: 16PM300S
 Packed: 10 Lengths Min Qty: 10

Size: 6m (19'8") White Code: 16PM600W
 Size: 6m (19'8") Silver Code: 16PM600T
 Size: 6m (19'8") Silver Metallic Code: 16PM600S
 Packed: 10 Lengths Min Qty: 10
 Please see page 116 for more details and compatible components.

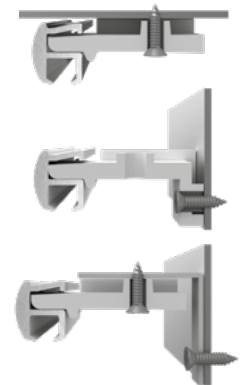
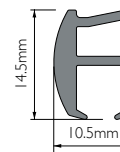

DISCLAIMER: Whilst every effort has been made to ensure colour accuracy, due to the limitations of colour printing, please refer to product samples for colour matching. Product dimensions are for guidance only and may differ – please confirm details at time of ordering.

Aluminium Curtain Tracks – 4mm Channel Profiles

Profile Comparison: 4mm Single Channel Aluminium Tracks



Professional Large Curved Aluminium Profile Track 4mm Channel

Size: 3m (9'10")		White	Code: 16CP300W
Size: 3m (9'10")		Antique Brass	Code: 16CP300Q
Size: 3m (9'10")		Silver Metallic	Code: 16CP300S
Size: 3m (9'10")		Silver	Code: 16CP300T
Size: 3m (9'10")		Anthracite	Code: 16CP300A
Size: 3m (9'10")		Gold	Code: 16CP300G
Size: 3m (9'10")		Sand	Code: 16CP300C
Size: 3m (9'10")		Black	Code: 16CP300K

Packed: 10 Lengths Min Qty: 10

Size: 6m (9'10")		White	Code: 16CP600W
Size: 6m (9'10")		Antique Brass	Code: 16CP600Q
Size: 6m (9'10")		Silver Metallic	Code: 16CP600S
Size: 6m (9'10")		Silver	Code: 16CP600T
Size: 6m (9'10")		Anthracite	Code: 16CP600A
Size: 6m (9'10")		Gold	Code: 16CP600G
Size: 6m (9'10")		Sand	Code: 16CP600C
Size: 6m (9'10")		Black	Code: 16CP600K

Packed: 10 Lengths Min Qty: 10

Please see page 119 for more details and compatible components.

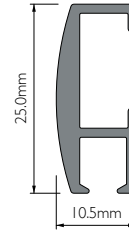

Mini U-Section Aluminium Track – Top Fix 4mm Channel Predrilled with holes

Size: 6m (19'8") White Code: 16UT600W

Packed: 10 Lengths Min Qty: 10 *Special order only

Please see page 123 for more details and compatible components.

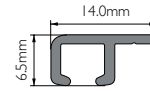

125mm between predrilled holes

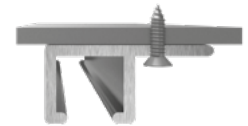

Mini U-Section Aluminium Track – Wall Fix 4mm Channel Predrilled with holes

Size: 6m (19'8") White Code: 16UW600W

Packed: 10 Lengths Min Qty: 10 *Special order only

Please see page 123 for more details and compatible components.

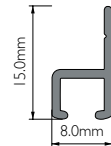

125mm between predrilled holes



DISCLAIMER: Whilst every effort has been made to ensure colour accuracy, due to the limitations of colour printing, please refer to product samples for colour matching. Product dimensions are for guidance only and may differ – please confirm details at time of ordering.

Aluminium Curtain Tracks – 6mm Channel Profiles

Profile Comparison: 6mm Single Channel Aluminium Tracks

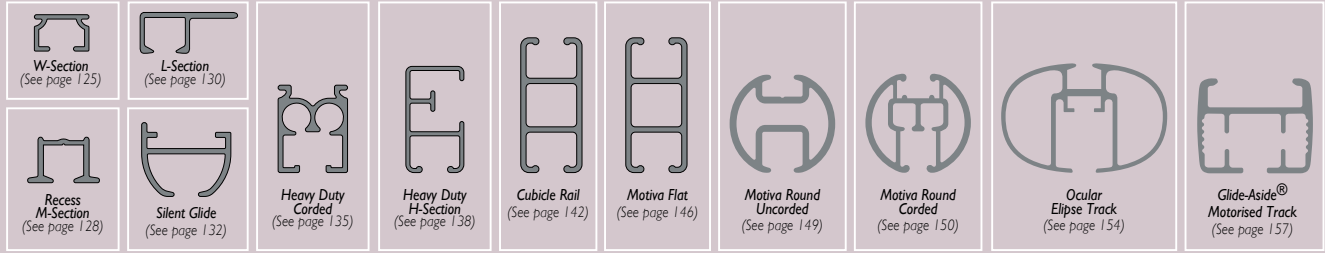

W-Section Aluminium Profile Track 6mm Channel

Size: 6m (19'8") White Code: 16WS600W
 Size: 6m (19'8") Black Code: 16WS600K

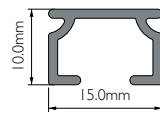

W-Section Aluminium Profile Track – Predrilled with holes

Size: 6m (19'8") White Code: 16WH600W
 Size: 6m (19'8") Black Code: 16WH600K

Packed: 10 Lengths Min Qty: 10

Please see [page 125](#) for more details and compatible components.

300mm between predrilled holes



Recess M-Section Aluminium Profile Track 6mm Channel

Size: 6m (19'8") White Code: 16RM600W

Packed: 10 Lengths Min Qty: 10

Please see [page 128](#) for more details and compatible components.

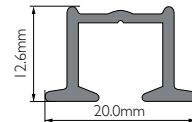

L-Section Aluminium Profile Track 6mm Channel

Size: 585cm (19'2") White Code: 16LS585W

Packed: 10 Lengths Min Qty: 10

Please see [page 130](#) for more details and compatible components.

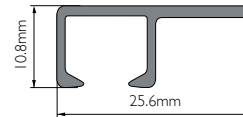

Silent Glide Aluminium Profile Track 6mm Channel

Size: 6m (19'8") White Code: 16SG600W
 Size: 6m (19'8") Silver Code: 16SG600T
 Size: 6m (19'8") Black Code: 16SG600K

Packed: 20 Lengths Min Qty: 20

Please see [page 132](#) for more details and compatible components.

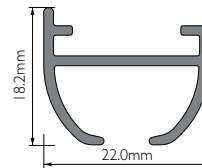

Heavy Duty Corded Aluminium Profile Track 6mm Channel

Size: 3m (9'10") White Code: 16HD300W

Size: 6m (19'8") White Code: 16HD600W

Packed: 5 Lengths Min Qty: 5

Please see [page 135](#) for more details and compatible components.

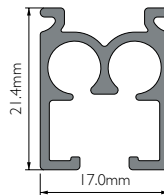

Heavy Duty H-Section Aluminium Profile Track 6mm Channel

Size: 6m (19'8") White Code: 16HH600W

Size: 6m (19'8") Silver Code: 16HH600T

Size: 6m (19'8") Black Code: 16HH600K

Packed: 10 Lengths Min Qty: 10

Please see [page 138](#) for more details and compatible components.

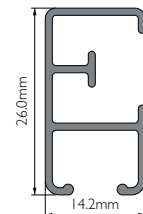

Cubicle Rail 6mm Channel

Size: 6m (19'8") White Code: 16HO600W

Size: 6m (19'8") Silver Anodised Code: 16HO600S

Packed: 10 Lengths Min Qty: 10

Please see [page 142](#) for more details and compatible components.

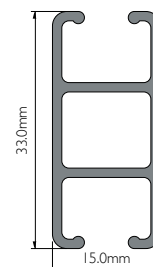

DISCLAIMER: Whilst every effort has been made to ensure colour accuracy, due to the limitations of colour printing, please refer to product samples for colour matching. Product dimensions are for guidance only and may differ – please confirm details at time of ordering.

Aluminium Curtain Tracks – 6mm Channel Profiles

Profile Comparison: 6mm Single Channel Aluminium Tracks

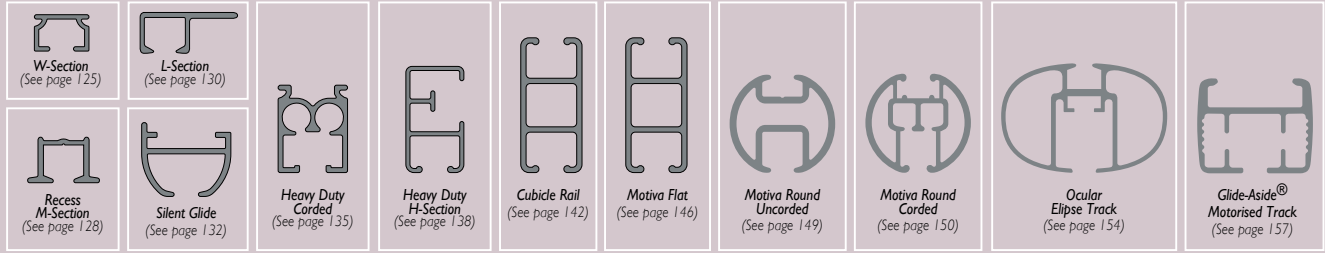

Motiva Flat Aluminium Profile Track 6mm Channel



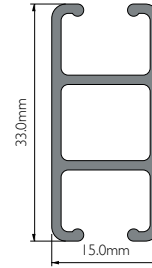

Size: 6m (19'8")  White Code: 16MF600W
 Size: 6m (19'8")  Silver Code: 16MF600T
 Size: 6m (19'8")  Black Code: 16MF600K
 Packed: 10 Lengths **Min Qty: 10**
 Please see [page 146](#) for more details and compatible components.



Motiva Round Uncorded Aluminium Profile Track 6mm Channel



Size: 6m (19'8")  White Code: 16MO600W
 Size: 6m (19'8")  Silver Code: 16MO600T
 Size: 6m (19'8")  Black Code: 16MO600K
 Packed: 20 **Min Qty: 10**
 Please see [page 149](#) for more details and compatible components.

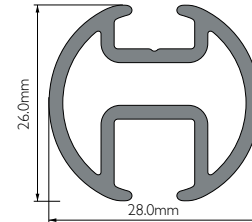

Motiva Round Corded Aluminium Profile Track 6mm Channel



Size: 6m (19'8")  White Code: 16MC600W
 Size: 6m (19'8")  Silver Code: 16MC600T
 Size: 6m (19'8")  Black Code: 16MC600K
 Packed: 20 **Min Qty: 10**
 Please see [page 150](#) for more details and compatible components.

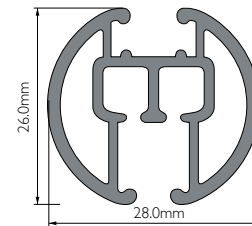

Ocular Aluminium Profile Track 6mm Channel



Size: 6m (19'8")  Polar Code: 16OC600P
 Size: 6m (19'8")  Dune Code: 16OC600D
 Size: 6m (19'8")  Mist Code: 16OC600M
 Size: 6m (19'8")  Storm Code: 16OC600S
 Size: 6m (19'8")  Noir Code: 16OC600N
 Packed: 20 **Min Qty: 10**
 Please see [page 154](#) for more details and compatible components.

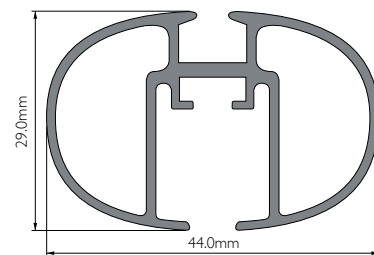

Motorised Aluminium Curtain Tracks

Renaissance Glide-Aside Motorised Curtain Track 6mm Channel



Size: 6m (19'8")  White Code: 16GA600W
 Packed: 10 Lengths **Min Qty: 10**
 Please see [page 157](#) for more details and compatible components.

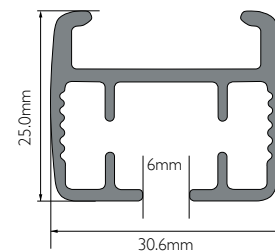

DISCLAIMER: Whilst every effort has been made to ensure colour accuracy, due to the limitations of colour printing, please refer to product samples for colour matching. Product dimensions are for guidance only and may differ – please confirm details at time of ordering.

Optimal H-Section Aluminium Profile Track

Optimal Aluminium H-Section curtain track suitable for many contract applications. A heavier aluminium track available with a strong white powder coating. Track can be joined and is available for contract in 3m/6m (9'10"/19'8") lengths or ready assembled Kits in a clear plastic pack.

Ceiling supports for cubicle use are available.

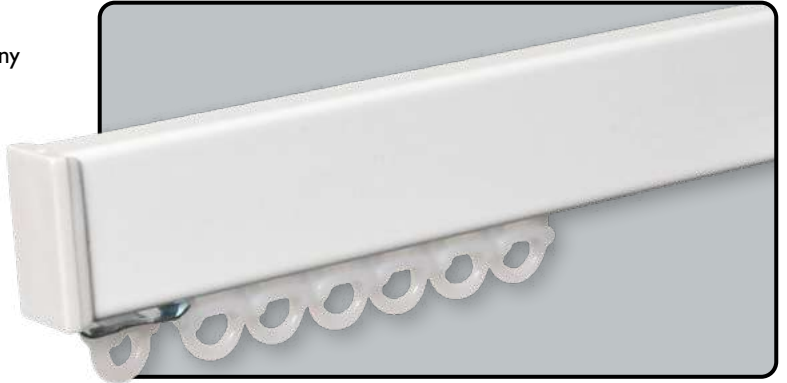

For Curtain Hooks see this Catalogue page 217



Optimal H-Section Aluminium Profile Track 4mm Channel

Size: 3m (9'10") White Code: 16OP300W
 Packed: 10 Lengths Min Qty: 10

Size: 6m (19'8") White Code: 16OP600W
 Packed: 20 Lengths Min Qty: 20



Colour finish available:
WHITE
 RAL 9016

Profile Weight: 170g/m

Made-to-measure Kits include Track, Brackets, Gliders, End Caps & End Stops. An essential time saver for the professional fitter – see below for details.



Optimal H-Section Aluminium Profile Track Kit Components

NOTE: Kits are available up to the size ordered and can also be produced to your specific size.

Components	Track Kit Sizes							
	1.00m (3'3")	1.50m (4'11")	2.00m (6'7")	2.50m (8'2")	3.00m* (9'10")	4.00m* (13'1")	5.00m* (16'5")	6.00m* (19'8")
Profile Track	1 x 1.00m	1 x 1.50m	1 x 2.00m	1 x 2.50m	2 x 1.50m	2 x 2.00m	2 x 2.50m	2 x 3.00m
Brackets**	3	4	5	6	7	9	11	13
End Caps	2	2	2	2	2	2	2	2
Gliders^	10	16	20	26	30	40	50	60
Twist End Stops	2	2	2	2	2	2	2	2
Standard Glider Kit Code	16OPUS100W	16OPUS150W	16OPUS200W	16OPUS250W	16OPUS300W	16OPUS400W	16OPUS500W	16OPUS600W
60mm SurgeWave Kit Code	16OPU6100W	16OPU6150W	16OPU6200W	16OPU6250W	16OPU6300W	16OPU6400W	16OPU6500W	16OPU6600W
80mm SurgeWave Kit Code	16OPU8100W	16OPU8150W	16OPU8200W	16OPU8250W	16OPU8300W	16OPU8400W	16OPU8500W	16OPU8600W

Packed: 1 px / Outer 5 Min Qty: 1

NOTE: Kits come with 10 gliders per m unless otherwise specified.

* Denotes 2 piece profile with joiner. All kits include fittings.

** Standard Glider Kits = 4cm Click Wall/Ceiling Brackets • 60mm and 80mm SurgeWave Kits = Ceiling Brackets (for wall fix please add your chosen L-Extension brackets to your order).

^For SurgeWave Kits the gliders are replaced with SurgeWave Gliders-on-a-string – see p176–177 to calculate the number of SurgeWave Gliders required.

<p>This curtain track is suitable for light-to-medium weight curtains</p>	<p>Suitable for straight runs and can also be bent</p>	<p>Kits/components are delivered in transport or retail packaging</p>	<p>Available in contract components for large jobs</p>	<p>Available in kit form for simple ordering</p>	<p>Tracks available made-to-measure</p>
---	--	---	--	--	---

DISCLAIMER: Whilst every effort has been made to ensure colour accuracy, due to the limitations of colour printing, please refer to product samples for colour matching. Product dimensions are for guidance only and may differ – please confirm details at time of ordering.

Optimal H-Section Aluminium Profile Track – Accessories

Brackets



Optimal H-Section Profile 4cm
Click Wall/Ceiling Bracket
 White Code: 16OPC4CW
Packed: 100 Min Qty: 100



Optimal H-Section Profile 4cm
Standard Wall/Ceiling Bracket
 White Code: 16OPB4CW
Packed: 100 Min Qty: 100

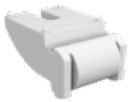

Ceiling Standard Bracket
(with Slot)
 White Code: 16HSBCCW
Packed: 100 Min Qty: 100



Ceiling Standard Bracket
(with Hole)
 White Code: 16HSBHCW
Packed: 100 Min Qty: 100



4cm Standard Wall/Ceiling Bracket
 White Code: 16HSB4CW
Packed: 100 Min Qty: 100



6cm Standard Wall/Ceiling Bracket
 White Code: 16HSB6CW
Packed: 100 Min Qty: 100

S 60mm



Flush Wall Fix Bracket
 White Code: 16HSFBCW
Packed: 100 Min Qty: 100

Joiner & Corner Connector



Optimal H-Section Profile
Corner Connector 90°
 White Code: 16OP90CW
Packed: 100 Min Qty: 100



H-Section Profile Joiner
Code: 16HSJODW
Packed: 10 Min Qty: 10

Also works on Optimal, Principal (White ONLY), Professional & Heavy Duty H-Section

End Cap and End Stops



Optimal H-Section End Cap
 White Code: 16OPECCW
Packed: 100 Min Qty: 100



Optimal/Principal H-Section and Professional
Large Curved Profile End Cap with Screw/Eye
 White Code: 16HSCSCW
Packed: 100 Min Qty: 100



Twist-Fit End Stop for 4mm Channel
 White Code: 16HSESCW
Packed: 100 Min Qty: 100



Metal Twist Stop for 4mm Channel
 Silver Code: 16HSTSCS
Packed: 100 Min Qty: 100

Gliders & Glider Accessories



Standard Gliders for 4mm Channel
Strips of 20 (20 x 50)
 White Code: 16HSSGKW
Packed: 1000 Min Qty: 1000



Click-In Gliders for 4mm Channel
 White Code: 16HSCGKW
Packed: 1000 Min Qty: 100



Metal Overlap Arm for 4mm Channel
 White Code: 16HSOLIW
Packed: 10 Min Qty: 10



Metal Underlap Arm for 4mm Channel
 White Code: 16HSULIW
Packed: 10 Min Qty: 10

These Glider Attachments can be added to gliders with an 'eye' to connect to curtains



Plastic S-Hook Code: 16HO995W
Packed: 1000 Min Qty: 1000

Large Metal S-Hook 39mm Code: 16HO072S
Small Metal S-Hook 29mm Code: 16HO071S
Packed: 100 Min Qty: 100

SurgeWave® System Gliders & Accessories



SurgeWave® System Gliders-on-a-String
for 4mm Channel
Spacing: 60mm Code: 16HS60GLST
Spacing: 80mm Code: 16HS80GLST
Packed: 25m Min Qty: 25m



SurgeWave® System Curtain Tape
With 60mm & 80mm Spacing Guides
 White Packed: 50m Code: 51TOWA3R
 White Packed: 100m Code: 51TOWA3CR
 Black Packed: 50m Code: 51TOWAK3R
Min Qty: 100m



Iron-on SurgeWave® System Curtain Tape
 White Packed: 50m Code: 51TOWIA3R
Min Qty: 100m



Friction Gliders for SurgeWave® System
 White Packed: 1 Code: 16HSFG1W
 White Packed: 10 Code: 16HSFGDW
 White Packed: 100 Code: 16HSFGCW



Neat Pleat Guide for SurgeWave® System
Clips onto 4mm & 6mm SurgeWave Gliders
 White Code: 16SURNP-
Packed: 10 Min Qty: 10

For more details on how the SurgeWave® System works please see pages 165–180 in this Catalogue



DISCLAIMER: Whilst every effort has been made to ensure colour accuracy, due to the limitations of colour printing, please refer to product samples for colour matching. Product dimensions are for guidance only and may differ – please confirm details at time of ordering.

Optimal H-Section Aluminium Profile Track – Accessories

Ceiling Support

Suspended Ceiling Bracket

Used with tracks or blinds to fix to suspended ceilings.

White Code: 16HSSCCW
Packed: 100 Min Qty: 10

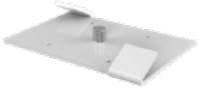

Ceiling Suspension Hanger Kit Ø8mm Tube

White Size: 100cm (3'3") Code: 16CSI01W

White Size: 150cm (4'11") Code: 16CSI15W

Packed: 1 Min Qty: 1

Note: These can be cut to the required drop



Suitable to work with any bracket or track with ceiling fix option to create distance between the ceiling and the track.



L-Extension Brackets & Covers

L-Extension Brackets can be used with tracks and blinds to increase the projection from the wall to the desired length. Covers are also available for a neat finish. See below.

3cm L-Extension Bracket

White Code: 16LB031W
Packed: 10 Min Qty: 10



9cm L-Extension Bracket

White Code: 16LB091W
Packed: 10 Min Qty: 10



S 80mm

S 60mm

14cm L-Extension Bracket

White Code: 16LB141W
Packed: 10 Min Qty: 10



S 80mm

S 60mm

Screw for Double Track use Code: 16LSSCREW Packed: 10 Min Qty: 10

L-Extension Bracket Cover

A one-size-fits all solution for any size L-Extension Bracket – simply snap-off to fit to size.

White Code: 16LBCOVW
Packed: 10 Min Qty: 10



10mm Track Spacers Ideal for projecting a bracket further from the wall or ceiling

White Code: 16HSSPCW
Packed: 100 Min Qty: 100



Bends and Bending Tools

Table Mounted Bending Tool for Optimal H-Section, Principal H-Section & W-Section Profile (includes 1 set of bending inserts)

Code: 16HSPBEN

Packed: 1 Min Qty: 1



Internal and external bends can be formed

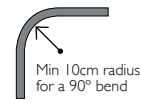

Min 10cm radius for a 90° bend

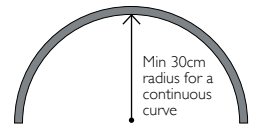

Min 30cm radius for a continuous curve

Large Portable Bending Tool for Optimal H-Section, Principal H-Section, Professional Large Curved Profile, W-Section Profile, Heavy Duty H-Section Profile and Cubicle Rail (includes 1 set of bending inserts)

Code: 16MPLBEN

Packed: 1 Min Qty: 1



Internal and external bends can be formed

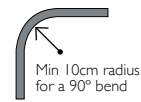

Min 10cm radius for a 90° bend

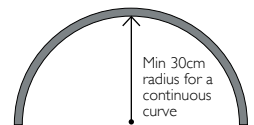

Min 30cm radius for a continuous curve

Handheld Bending Tool for Optimal H-Section Profile (includes 1 set of bending inserts)

Code: 16HSHBEN

Packed: 1 Min Qty: 1



Spare Bending Insert Sets (2-piece)

Insert into the glider and bracket channel of aluminium track to prevent damage to the channel whilst bending

Code: 16OPINST

Packed: 1 Min Qty: 1



Made-to-Measure Cutting Service

Code: 16MTMTRK

Optimal Track Bending Service:

Single Angle Bend Code: 16OPBEND

Continuous Curve Code: 16OPCONT

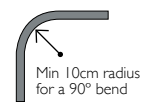
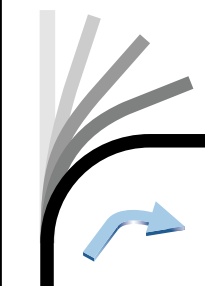

Min 10cm radius for a 90° bend

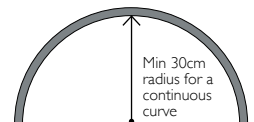

Min 30cm radius for a continuous curve

Please see page 227 for the Renaissance Metal Track Bending Form

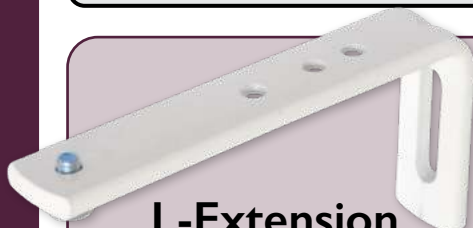

L-Extension Brackets

To help stop blinds/curtains catching on protruding radiators or door handles. Also ideal for wall mounted SurgeWave Tracks to ensure there is enough clearance space for the deep pleats SurgeWave creates.

Available in various Sizes & Colours



Double Track Solution

Additional L-Extension Screw also available to allow for Double Track usage too!



ONE SIZE FITS ALL SOLUTION

Available in 3 colours

L-Extension Bracket Covers

For a super-neat finish the one size cover is compatible with all sizes of L-Extension Brackets

This design will work on all sizes of L-Extension bracket. Simply bend the bracket cover at the designated break marker and it will snap-off to your required size. Simple!

For Double Track the bracket cover can only be used up to the first track

Principal H-Section

Aluminium Profile Track

Principal Aluminium H-Section curtain track suitable for many domestic and contract applications. Available in our core three colours – White, Silver & Black – in 3m/6m (9'10"/19'8") lengths. Principal Track has a wide range of brackets and accessories to optimise fitting and function. Ceiling supports for cubicle use are also available.

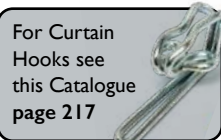
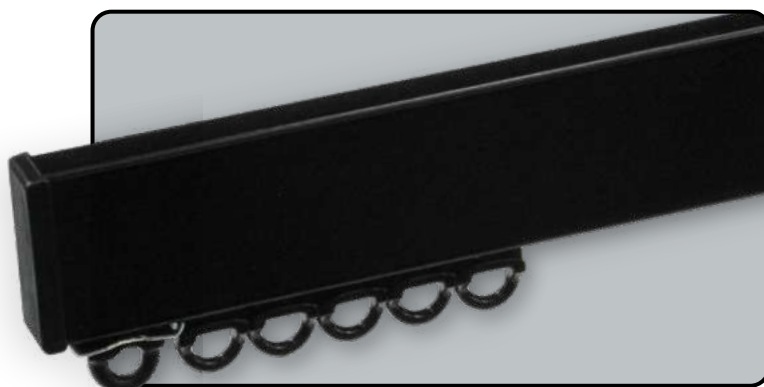

For Curtain Hooks see this Catalogue page 217



Principal H-Section Aluminium Profile Track

4mm Channel

Size: 3m (9'10")  White Code: 16HS300W
 Size: 3m (9'10")  Silver Code: 16HS300T
 Size: 3m (9'10")  Black Code: 16HS300K
 Packed: 10 Lengths **Min Qty: 10**

Size: 6m (19'8")  White Code: 16HS600W
 Size: 6m (19'8")  Silver Code: 16HS600T
 Size: 6m (19'8")  Black Code: 16HS600K
 Packed: 30 Lengths **Min Qty: 20**



Please note at time of press some stocks of this profile are 25mm in depth. Please check details before ordering.

Colour finishes available:

WHITE W
RAL 9016

SILVER T
RAL 9006

BLACK K
RAL 9005

Insert your chosen colour letter reference at end of the Kit Code.

Profile Weight: 126g/m

Made-to-measure Kits include Track, Brackets, Gliders, End Caps & End Stops. An essential time saver for the professional fitter – see below for details.

Principal H-Section Aluminium Profile Track Kit Components

NOTE: Kits are available up to the size ordered and can also be produced to your specific size.

Components	Track Kit Sizes							
	1.00m (3'3")	1.50m (4'11")	2.00m (6'7")	2.50m (8'2")	3.00m* (9'10")	4.00m* (13'1")	5.00m* (16'5")	6.00m* (19'8")
Profile Track	1 x 1.00m	1 x 1.50m	1 x 2.00m	1 x 2.50m	2 x 1.50m	2 x 2.00m	2 x 2.50m	2 x 3.00m
Brackets**	3	4	5	6	7	9	11	13
End Caps	2	2	2	2	2	2	2	2
Gliders^	10	16	20	26	30	40	50	60
Twist End Stops	2	2	2	2	2	2	2	2
Standard Glider Kit Code †	16HSUS100_	16HSUS150_	16HSUS200_	16HSUS250_	16HSUS300_	16HSUS400_	16HSUS500_	16HSUS600_
60mm SurgeWave Kit Code †	16HSU6100_	16HSU6150_	16HSU6200_	16HSU6250_	16HSU6300_	16HSU6400_	16HSU6500_	16HSU6600_
80mm SurgeWave Kit Code †	16HSU8100_	16HSU8150_	16HSU8200_	16HSU8250_	16HSU8300_	16HSU8400_	16HSU8500_	16HSU8600_

Packed: 1 px / Outer 5 **Min Qty: 1**

NOTE: Kits come with 10 gliders per m unless otherwise specified.

† Insert your chosen colour letter reference at end of the Kit Code.

* Denotes 2 piece profile with joiner. All kits include fittings.

** Standard Glider Kits = 4cm Leverlock Wall/Ceiling Brackets • 60mm SurgeWave Kits = 6cm Wall/Ceiling Leverlock Brackets • 80mm SurgeWave Kits = 8cm Leverlock Brackets

^For SurgeWave Kits the gliders are replaced with SurgeWave Gliders-on-a-string – see **p176-177** to calculate the number of SurgeWave Gliders required.



This curtain track is suitable for light-to-medium weight curtains

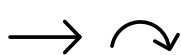

Suitable for straight runs and can also be bent



Kits/components are delivered in transport or retail packaging



Available in contract components for large jobs



Available in kit form for simple ordering



Tracks available made-to-measure

DISCLAIMER: Whilst every effort has been made to ensure colour accuracy, due to the limitations of colour printing, please refer to product samples for colour matching. Product dimensions are for guidance only and may differ – please confirm details at time of ordering.

Principal H-Section Aluminium Profile Track – Accessories

Brackets



Ceiling Standard Bracket (with Slot)

White Code: 16HSBCCW
Packed: 100 Min Qty: 100



Ceiling Standard Bracket (with Hole)

White Code: 16HSBHCCW
Black Code: 16HSBHCK
Packed: 100 Min Qty: 100



4cm Standard Wall/Ceiling Bracket

White Code: 16HSB4CW
Packed: 100 Min Qty: 100



6cm Standard Wall/Ceiling Bracket

White Code: 16HSB6CW
Packed: 100 Min Qty: 100

S60mm



3cm Click Wall/Ceiling Bracket

White Code: 16HSC3CW
Packed: 100 Min Qty: 100



4cm Click Wall/Ceiling Bracket

White Code: 16HSC4CW
Packed: 100 Min Qty: 100



5cm Click Wall/Ceiling Bracket

White Code: 16HSC5CW
Packed: 100 Min Qty: 100



4cm Leverlock Wall/Ceiling Bracket

White Code: 16HSL4CW
Grey Code: 16HSL4CT
Black Code: 16HSL4CK
Packed: 100 Min Qty: 100



5cm Leverlock Wall/Ceiling Bracket

White Code: 16HSL5CW
Grey Code: 16HSL5CT
Black Code: 16HSL5CK
Packed: 100 Min Qty: 100



6cm Leverlock Wall/Ceiling Bracket

White Code: 16HSL6CW
Grey Code: 16HSL6CT
Black Code: 16HSL6CK
Packed: 100 Min Qty: 100

S60mm



8cm Leverlock Wall/Ceiling Bracket

White Code: 16HSL8CW
Grey Code: 16HSL8CT
Black Code: 16HSL8CK
Packed: 100 Min Qty: 100

S80mm

S60mm

Brackets



Ceiling Leverlock Bracket (with Hole)

White Code: 16HSLCCW
Grey Code: 16HSLCCT
Black Code: 16HSLCCK
Packed: 100 Min Qty: 100



Flush Wall Fix Bracket

White Code: 16HSFBCW
Packed: 100 Min Qty: 100

L-Extension Brackets & Ceiling Suspension

L-Extension Brackets can be used with tracks and blinds to increase the projection from the wall to the desired length. Covers are also available for a neat finish. See page 110.



3cm L-Extension Bracket

White Code: 16LB031W
Packed: 10 Min Qty: 10



9cm L-Extension Bracket

White Code: 16LB091W
Silver Code: 16LB091S
Black Code: 16LB091K
Packed: 10 Min Qty: 10

S80mm

S60mm



14cm L-Extension Bracket

White Code: 16LB141W
Packed: 10 Min Qty: 10

S80mm

S60mm

Screw for Double Track use Code: 16LSSCREW Packed: 10 Min Qty: 10



L-Extension Bracket Cover

A one-size-fits all solution for any size L-Extension Bracket – simply snap-off to fit to size.

White Code: 16LBCOVW
Grey Code: 16LBCOVT
Black Code: 16LBCOVK
Packed: 10 Min Qty: 10



Ceiling Suspension Hanger Kit Ø8mm Tube

White Size: 100cm (3'3") Code: 16CS101W
White Size: 150cm (4'11") Code: 16CS151W
Packed: 1 Min Qty: 1

Note: These can be cut to the required drop

Suitable to work with any bracket or track with ceiling fix option to create distance between the ceiling and the track.



Track Joiners



H-Section Profile Joiner

Works with Optimal, Principal (White ONLY), Professional & Heavy Duty H-Section Tracks

Code: 16HSJODW

Packed: 10 Min Qty: 10



Principal H-Section Joiner

Works with Principal (Silver) & Veltrack Profile

Code: 16HSJODT

Packed: 10 Min Qty: 10

DISCLAIMER: Whilst every effort has been made to ensure colour accuracy, due to the limitations of colour printing, please refer to product samples for colour matching. Product dimensions are for guidance only and may differ – please confirm details at time of ordering.

Principal H-Section Aluminium Profile Track – Accessories

Glidors & Glider Accessories



Standard Gliders for 4mm Channel

- White Code: 16HSSGKW
 - Grey Code: 16HSSGKT
 - Black Code: 16HSSGKK
- Packed: 1000 Min Qty: 1000

Strips of 20 (20 x 50)



Click-In Gliders for 4mm Channel

- White Code: 16HSCGKW
- Packed: 1000 Min Qty: 100



Metal Overlap Arm for 4mm Channel

- White Code: 16HSOL1W
- Packed: 10 Min Qty: 10



Metal Underlap Arm for 4mm Channel

- White Code: 16HSUL1W
- Packed: 10 Min Qty: 10

These Glider Attachments can be added to gliders with an 'eye' to connect to curtains



Plastic S-Hook Code: 16HO995W
Packed: 1000 Min Qty: 1000

Large Metal S-Hook 39mm Code: 16HO072S

Small Metal S-Hook 29mm Code: 16HO071S

Packed: 100 Min Qty: 100

SurgeWave® System Gliders & Accessories

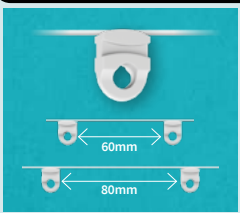

SurgeWave® System Gliders-on-a-String for 4mm Channel

- White Spacing: 60mm Code: 16HS60GLST
- White Spacing: 80mm Code: 16HS80GLST
- Black Spacing: 60mm Code: 16HS60GLSK
- Black Spacing: 80mm Code: 16HS80GLSK

Packed: 25m Min Qty: 25m



SurgeWave® System Curtain Tape With 60mm & 80mm Spacing Guides

- White Packed: 50m Code: 51TOWA3R
 - White Packed: 100m Code: 51TOWA3CR
 - Black Packed: 50m Code: 51TOWAK3R
- Min Qty: 100m



Iron-on SurgeWave® System Curtain Tape

- White Packed: 50m Code: 51TOWIA3R
- Min Qty: 100m



Friction Gliders for SurgeWave® System

- White Packed: 10 Code: 16HSFGDW
- White Packed: 100 Code: 16HSFGCW
- Grey Packed: 10 Code: 16HSFGDT
- Grey Packed: 100 Code: 16HSFGCT
- Black Packed: 10 Code: 16HSFGDK
- Black Packed: 100 Code: 16HSFGCK

Helps prevent curtain spring-back



Neat Pleat Guide for SurgeWave® System

- Clips onto 4mm & 6mm SurgeWave Gliders
 - White Code: 16SURNP-
- Packed: 10 Min Qty: 10

For more details on how the SurgeWave® System works please see pages 165–180 in this Catalogue



End Caps & End Stops



Principal H-Section Profile White End Cap

- White Code: 16HSECCW
 - Grey Code: 16HSECCT
 - Black Code: 16HSECCK
- Packed: 100 Min Qty: 100



Optimal/Principal H-Section and Professional Large Curved Profile End Cap with Screw/Eye

- White Code: 16HSCSCW
- Packed: 100 Min Qty: 100



Twist-Fit End Stop for 4mm Channel

- White Code: 16HSESCW
 - Grey Code: 16HSEECT
 - Black Code: 16HSEECK
- Packed: 100 Min Qty: 100



Metal Twist Stop for 4mm Channel

- Silver Code: 16HSTSCS
- Packed: 100 Min Qty: 100

Bends and Bending Tools

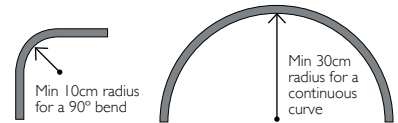

Table Mounted Bending Tool for Optimal H-Section, Principal H-Section & W-Section Profile (includes 1 set of bending inserts)

Code: 16HSPBEN

Packed: 1 Min Qty: 1

Internal and external bends can be formed



Min 10cm radius for a 90° bend

Min 30cm radius for a continuous curve



Large Portable Bending Tool for Optimal H-Section, Principal H-Section, Professional Large Curved Profile, W-Section Profile, Heavy Duty H-Section Profile and Cubicle Rail (includes 1 set of bending inserts)

Code: 16MPLBEN

Packed: 1 Min Qty: 1

Internal and external bends can be formed



Min 10cm radius for a 90° bend

Min 30cm radius for a continuous curve

Spare Bending Insert Sets (2-piece)

Insert into the glider and bracket channel of aluminium track to prevent damage to the channel whilst bending

Code: 16HSINST

Packed: 1 Min Qty: 1

Made-to-Measure Cutting Service

Code: 16MTMTRK

Principal Track Bending Service:

Single Angle Bend

Code: 16HSBEND

Continuous Curve

Code: 16HSCONT



Min 10cm radius for a 90° bend

Min 30cm radius for a continuous curve

Please see page 227 for the Renaissance Metal Track Bending Form

DISCLAIMER: Whilst every effort has been made to ensure colour accuracy, due to the limitations of colour printing, please refer to product samples for colour matching. Product dimensions are for guidance only and may differ – please confirm details at time of ordering.

Mini Optimal H-Section

Aluminium Profile Track

Mini Optimal Aluminium H-Section curtain track suitable for many contract applications. Available with a strong white powder coating. Track can be joined and is available for contract in 3m/6m (9'10"/19'8") lengths or ready assembled Kits.

Ceiling supports for cubicle use are also available.

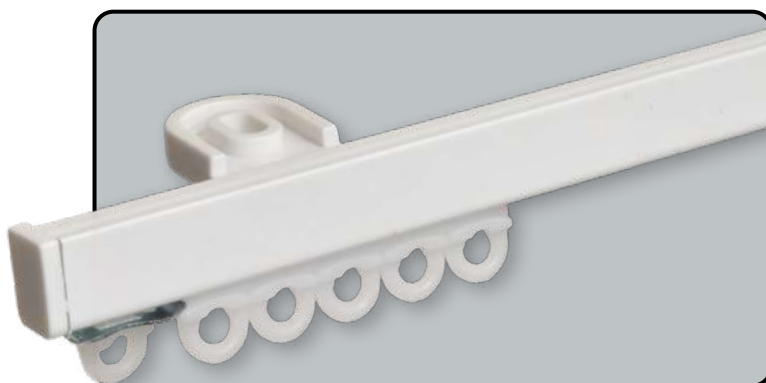

For Curtain Hooks see this Catalogue page 217



Mini Optimal H-Section Aluminium Profile Track 4mm Channel

Size: 3m (9'10") White Code: I6OM300W
 Packed: 10 Lengths Min Qty: 10

Size: 6m (19'8") White Code: I6OM600W
 Packed: 20 Lengths Min Qty: 20

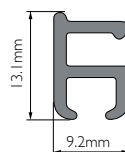

Colour finish available:
WHITE
 RAL 9016

Profile Weight: 116g/m

Made-to-measure Kits include Track, Brackets, Gliders, End Caps & End Stops. An essential time saver for the professional fitter – see below for details.

Mini Optimal H-Section Aluminium Profile Track Kit Components

NOTE: Kits are available up to the size ordered and can also be produced to your specific size.

Components	Track Kit Sizes							
	1.00m (3'3")	1.50m (4'11")	2.00m (6'7")	2.50m (8'2")	3.00m* (9'10")	4.00m* (13'1")	5.00m* (16'5")	6.00m* (19'8")
Profile Track	1 x 1.00m	1 x 1.50m	1 x 2.00m	1 x 2.50m	2 x 1.50m	2 x 2.00m	2 x 2.50m	2 x 3.00m
Ceiling Brackets	3	4	5	6	7	9	11	13
End Caps	2	2	2	2	2	2	2	2
Gliders^	10	16	20	26	30	40	50	60
Twist End Stops	2	2	2	2	2	2	2	2
Standard Glider Kit Code †	16OMUS100W	16OMUS150W	16OMUS200W	16OMUS250W	16OMUS300W	16OMUS400W	16OMUS500W	16OMUS600W
60mm SurgeWave Kit Code †	16OMU6100W	16OMU6150W	16OMU6200W	16OMU6250W	16OMU6300W	16OMU6400W	16OMU6500W	16OMU6600W
80mm SurgeWave Kit Code †	16OMU8100W	16OMU8150W	16OMU8200W	16OMU8250W	16OMU8300W	16OMU8400W	16OMU8500W	16OMU8600W

Packed: 1 px / Outer 5 Min Qty: 1

* Denotes 2 piece profile with joiner. All kits include fittings.

NOTE: Kits come with 10 gliders per m unless otherwise specified.

^ For SurgeWave Kits the gliders are replaced with SurgeWave Gliders-on-a-string – see p176–177 to calculate the number of SurgeWave Gliders required.

NOTE: All Kits include Ceiling Brackets as standard – Wall Fix brackets are sold separately – please add your chosen L-Extension bracket or Wall/Ceiling Brackets to your order.



This curtain track is suitable for light weight curtains



Suitable for straight runs and can also be bent



Kits/components are delivered in transport or retail packaging



Available in contract components for large jobs



Available in kit form for simple ordering



Tracks available made-to-measure

DISCLAIMER: Whilst every effort has been made to ensure colour accuracy, due to the limitations of colour printing, please refer to product samples for colour matching. Product dimensions are for guidance only and may differ – please confirm details at time of ordering.



Mini Optimal H-Section Aluminium Profile Track – Accessories

Brackets



Mini Optimal H-Section Profile Wall/Ceiling Bracket

White
Code: 16OMBWCW
Packed: 100 Min Qty: 100



Mini Optimal H-Section Profile Ceiling Bracket

White
Code: 16OMBCCW
Packed: 100 Min Qty: 100



L-Extension Brackets can be used with tracks and blinds to increase the projection from the wall to the desired length. Covers are also available for a neat finish. See page 110.



3cm L-Extension Bracket
 White Code: 16LB031W
Packed: 10 Min Qty: 10



9cm L-Extension Bracket
 White Code: 16LB091W S 80mm
Packed: 10 Min Qty: 10 S 60mm



14cm L-Extension Bracket
 White Code: 16LB141W S 80mm
Packed: 10 Min Qty: 10 S 60mm

Screw for Double Track use Code: 16LSSCREW Packed: 10 Min Qty: 10



L-Extension Bracket Cover
A one-size-fits all solution for any size L-Extension Bracket – simply snap-off to fit to size.
 White Code: 16LBCOVW
Packed: 10 Min Qty: 10

Suspended Ceiling Support

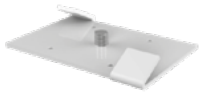

Suspended Ceiling Bracket
Used with tracks or blinds to fix to suspended ceilings.

White
Code: 16HSSCCW
Packed: 100
Min Qty: 10



Joiner



Mini Optimal Profile Joiner
 Silver Code: 16OMJODT
Packed: 10 Min Qty: 10



End Cap & End Stops



Mini Optimal H-Section Profile End Cap

White Code: 16OMECCW
Packed: 100 Min Qty: 100



Twist-Fit End Stop for 4mm Channel

White Code: 16HSESCW
Packed: 100 Min Qty: 100



Metal Twist Stop for 4mm Channel

Silver Code: 16HSTSCS
Packed: 100 Min Qty: 100

Gliders & Glider Accessories



Standard Gliders for 4mm Channel Strips of 20 (20 x 50)

White Code: 16HSSGKW
Packed: 1000 Min Qty: 1000



Click-In Gliders for 4mm Channel

White Code: 16HSCGKW
Packed: 1000 Min Qty: 100



Metal Overlap Arm for 4mm Channel

White Code: 16HSOLIW
Packed: 10 Min Qty: 10



Metal Underlap Arm for 4mm Channel

White Code: 16HSULIW
Packed: 10 Min Qty: 10

SurgeWave® System Gliders & Accessories



SurgeWave® System Gliders-on-a-String for 4mm Channel

Spacing: 60mm Code: 16HS60GLST
Spacing: 80mm Code: 16HS80GLST
Packed: 25m Min Qty: 25m



SurgeWave® System Curtain Tape With 60mm & 80mm Spacing Guides

White Packed: 50m Code: 51TOWA3R
 White Packed: 100m Code: 51TOWA3CR
Min Qty: 100m



Friction Gliders for SurgeWave® System

White Packed: 1 Code: 16HSFG1W
 White Packed: 10 Code: 16HSFGDW
 White Packed: 100 Code: 16HSFGCW



Neat Pleat Guide for SurgeWave® System
Clips onto 4mm & 6mm SurgeWave Gliders

White Code: 16SURNP-
Packed: 10 Min Qty: 10

For more details on how the SurgeWave® System works please see pages 165–180 in this Catalogue



Bends & Bending Tools



Spare Bending Insert Sets (2-piece)

Insert into the glider and bracket channel of aluminium track to prevent damage to the channel whilst bending
Code: 16OMINST
Packed: 1 Min Qty: 1



Made-to-Measure Cutting Service
Code: 16MTMTRK

Mini-Optimal Track Bending Service:
Single Angle Bend Code: 16OMBEND
Continuous Curve Code: 16OMCONT



Please see page 227 for the Renaissance Metal Track Bending Form

DISCLAIMER: Whilst every effort has been made to ensure colour accuracy, due to the limitations of colour printing, please refer to product samples for colour matching. Product dimensions are for guidance only and may differ – please confirm details at time of ordering.

Mini Professional Small Curved Aluminium Profile Track

Mini Professional Small Curved Aluminium Profile Track has a stylish and strong curved profile, offered in four metallic colours and a white finish, available in 3m/6m (9'10"/19'8") lengths or in pre-packed kits which are ready assembled. This track is suitable for many contract applications including use as a decorative blind bottom weight.

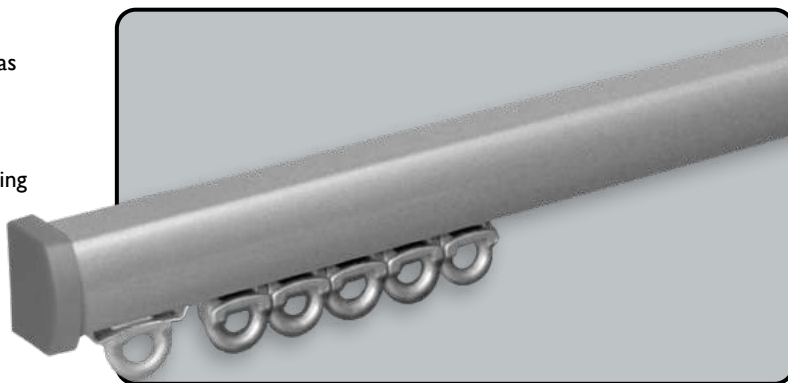

For Curtain Hooks see this Catalogue page 217



Mini Professional Small Curved Aluminium Profile Track 4mm Channel

- Size: 3m (9'10") White Code: I6PM300W
 - Size: 3m (9'10") Silver Code: I6PM300T
 - Size: 3m (9'10") Silver Metallic Code: I6PM300S
- Packed: 10 Lengths **Min Qty: 10**

- Size: 6m (19'8") White Code: I6PM600W
 - Size: 6m (19'8") Silver Code: I6PM600T
 - Size: 6m (19'8") Silver Metallic Code: I6PM600S
- Packed: 10 Lengths **Min Qty: 10**

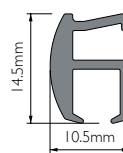

Colour finishes available:

WHITE RAL 9016	W
SILVER RAL 9006	T
SILVER METALLIC	S

Insert your chosen colour letter reference at end of the Kit Code.

Profile Weight: 170g/m

Made-to-measure Kits include Track, Ceiling Brackets, Gliders, End Caps & End Stops. An essential time saver for the professional fitter – see below for details.

Mini Professional Small Curved Profile Track Kit Components

NOTE: Kits are available up to the size ordered and can also be produced to your specific size.

Components	Track Kit Sizes							
	1.00m (3'3")	1.50m (4'11")	2.00m (6'7")	2.50m (8'2")	3.00m* (9'10")	4.00m* (13'1")	5.00m* (16'5")	6.00m* (19'8")
Profile Track	1 x 1.00m	1 x 1.50m	1 x 2.00m	1 x 2.50m	2 x 1.50m	2 x 2.00m	2 x 2.50m	2 x 3.00m
Ceiling Brackets	3	4	5	6	7	9	11	13
End Caps	2	2	2	2	2	2	2	2
Gliders^	10	16	20	26	30	40	50	60
Twist End Stops	2	2	2	2	2	2	2	2
Standard Glider Kit Code †	16PMUS100_	16PMUS150_	16PMUS200_	16PMUS250_	16PMUS300_	16PMUS400_	16PMUS500_	16PMUS600_
60mm SurgeWave Kit Code †	16PMU6100_	16PMU6150_	16PMU6200_	16PMU6250_	16PMU6300_	16PMU6400_	16PMU6500_	16PMU6600_
80mm SurgeWave Kit Code †	16PMU8100_	16PMU8150_	16PMU8200_	16PMU8250_	16PMU8300_	16PMU8400_	16PMU8500_	16PMU8600_

Packed: 1 px/Outer 5 **Min Qty: 1**

NOTE: Kits come with 10 gliders per m unless otherwise specified.

† Insert your chosen colour letter reference at end of the Kit Code.

* Denotes 2 piece profile with joiner. All kits include fittings.

^ For SurgeWave Kits the gliders are replaced with SurgeWave Gliders-on-a-string – see p176–177 to calculate the number of SurgeWave Gliders required.

NOTE: All Kits include Ceiling Brackets as standard – Wall Fix brackets are sold separately – please add your chosen L-Extension bracket or Wall/Ceiling Brackets to your order.



This curtain track is suitable for light-to-medium weight curtains

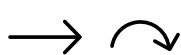

Suitable for straight runs and can also be bent



Kits/components are delivered in transport or retail packaging



Available in contract components for large jobs



Available in kit form for simple ordering



Tracks available made-to-measure

DISCLAIMER: Whilst every effort has been made to ensure colour accuracy, due to the limitations of colour printing, please refer to product samples for colour matching. Product dimensions are for guidance only and may differ – please confirm details at time of ordering.



Mini Professional Small Curved Aluminium Profile Track

Mini Professional Small Curved Aluminium Profile Track – Complete Kits

SILVER
T

new



SILVER METALLIC
S



WHITE
W



DISCLAIMER: Whilst every effort has been made to ensure colour accuracy, due to the limitations of colour printing, please refer to product samples for colour matching. Product dimensions are for guidance only and may differ – please confirm details at time of ordering.



Mini Professional Small Curved Aluminium Profile Track – Accessories

Brackets



Mini Professional Small Curved Profile Wall/Ceiling Bracket

White
Code: 16PMWBCW

Packed: 100 Min Qty: 100



Mini Professional Small Curved Profile Ceiling bracket

White
Code: 16PMCBCW

Packed: 100 Min Qty: 100



Suspended Ceiling Bracket

Used with tracks or blinds to fix to suspended ceilings.

White
Code: 16HSSCCW

Packed: 100
Min Qty: 10



L-Extension Brackets can be used with tracks and blinds to increase the projection from the wall to the desired length. Prevents curtains/blinds catching on protruding door and window handles. Covers are also available for a neat finish. See page 110.



End Cap & End Stops



Mini Professional Small Curved Profile End Cap

White Code: 16PMECCW
 Dark Grey Code: 16PMECCD
 Light Grey Code: 16PMECCL

Packed: 100 Min Qty: 100



Twist-Fit End Stop for 4mm Channel

White Code: 16HSESCW
 Grey Code: 16HSE SCT

Packed: 100 Min Qty: 100



Metal Twist Stop for 4mm Channel

Silver Code: 16HSTSCS

Packed: 100 Min Qty: 100

Gliders & Glider Accessories



Standard 4mm Gliders Strips of 20 (20 x 50)

White Code: 16HSSGKW
 Grey Code: 16HSSGKT

Packed: 1000 Min Qty: 1000



Click-In Gliders for 4mm Channel

White Code: 16HSCGKW

Packed: 1000 Min Qty: 100



Metal Overlap Arm for 4mm Channel

White Code: 16HSOLIW

Packed: 10 Min Qty: 10



Metal Underlap Arm for 4mm Channel

White Code: 16HSULIW

Packed: 10 Min Qty: 10

SurgeWave® System Gliders & Accessories



SurgeWave® System Gliders-on-a-String for 4mm Channel

Spacing: 60mm Code: 16HS60GLST

Spacing: 80mm Code: 16HS80GLST

Packed: 25m Min Qty: 25m



SurgeWave® System Curtain Tape
With 60mm & 80mm Spacing Guides

White Packed: 50m Code: 51TOWA3R

White Packed: 100m Code: 51TOWA3CR

Black Packed: 50m Code: 51TOWAK3R

Min Qty: 100m



Iron-on SurgeWave® System Curtain Tape

White Packed: 50m Code: 51TOWIA3R

Min Qty: 100m

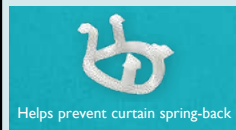

Friction Gliders for SurgeWave® System

White Packed: 1 Code: 16HSFG1W

White Packed: 10 Code: 16HSFGDW

White Packed: 100 Code: 16HSFGCW

Helps prevent curtain spring-back



Neat Pleat Guide for SurgeWave® System
Clips onto 4mm & 6mm SurgeWave Gliders

White Code: 16SURNP-

Packed: 10 Min Qty: 10

For more details on how the SurgeWave® System works please see pages 165–180 in this Catalogue



Joiner



Mini Professional Small Curved Profile Joiner

Silver Code: 16PMJODS

Packed: 10 Min Qty: 10

Bends & Bending Tools



Table Mounted Bending Tool for Mini Professional Small Curved Profile & Professional Large Curved Profile (includes 1 set of bending inserts)

Code: 16CPPBEN Packed: 1

Internal and external bends can be formed

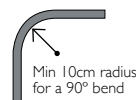

Min 10cm radius for a 90° bend

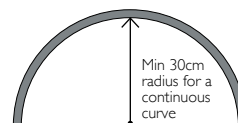

Min 30cm radius for a continuous curve

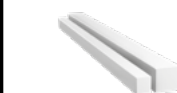

Spare Bending Insert Sets (2-piece)

Insert into the glider and bracket channel of aluminium track to prevent damage to the channel whilst bending

Code: 16PMINST Packed: 1

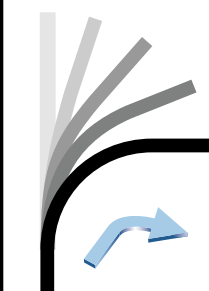

Made-to-Measure Cutting Service
Code: 16MTMTRK

Mini Professional Track Bending Service:
Single Angle Bend Code: 16PMBEND
Continuous Curve Code: 16PMCONT

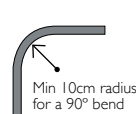

Min 10cm radius for a 90° bend

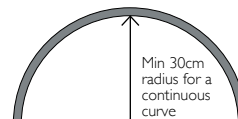

Min 30cm radius for a continuous curve

Please see page 227 for the Renaissance Metal Track Bending Form

DISCLAIMER: Whilst every effort has been made to ensure colour accuracy, due to the limitations of colour printing, please refer to product samples for colour matching. Product dimensions are for guidance only and may differ – please confirm details at time of ordering.

Professional Large Curved Aluminium Profile Track

Professional Large Curved Aluminium Profile Track has a stylish and strong curved profile, offered in a range of eight colour finishes available in 3m/6m (9'10"/19'8") lengths or in pre-packed kits which are ready assembled and available in a clear plastic pack. This track is suitable for many contract applications including use as a decorative blind bottom weight.

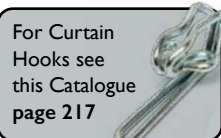

Profile Weight: 240g/m

Professional Large Curved Profile Track 4mm Channel

Size: 3m (9'10")	White	Code: I6CP300W
Size: 3m (9'10")	Silver	Code: I6CP300T
Size: 3m (9'10")	Black	Code: I6CP300K
Size: 3m (9'10")	Antique Brass	Code: I6CP300Q
Size: 3m (9'10")	Silver Metallic	Code: I6CP300S
Size: 3m (9'10")	Anthracite	Code: I6CP300A
Size: 3m (9'10")	Gold	Code: I6CP300G
Size: 3m (9'10")	Sand	Code: I6CP300C
Packed: 10 Lengths	Min Qty: 10	

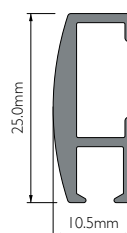

Size: 6m (19'8")	White	Code: I6CP600W
Size: 6m (19'8")	Silver	Code: I6CP600T
Size: 6m (19'8")	Black	Code: I6CP600K
Size: 6m (19'8")	Antique Brass	Code: I6CP600Q
Size: 6m (19'8")	Silver Metallic	Code: I6CP600S
Size: 6m (19'8")	Anthracite	Code: I6CP600A
Size: 6m (19'8")	Gold	Code: I6CP600G
Size: 6m (19'8")	Sand	Code: I6CP600C
Packed: 10 Lengths	Min Qty: 10	



Colour finishes available:

WHITE RAL 9016	W
SILVER RAL 9006	T
BLACK RAL 9005	K
ANTIQUE BRASS	Q
SILVER METALLIC	S
ANTHRACITE	A
GOLD	G
SAND	C

Insert your chosen colour letter reference at end of the Kit Code.

Made-to-measure Kits include Track, Brackets, Gliders, End Caps & End Stops. An essential time saver for the professional fitter – see below for details.

Professional Large Curved Profile Track Kit Components

NOTE: Kits are available up to the size ordered and can also be produced to your specific size.

Components	Track Kit Sizes							
	1.00m (3'3")	1.50m (4'11")	2.00m (6'7")	2.50m (8'2")	3.00m* (9'10")	4.00m* (13'1")	5.00m* (16'5")	6.00m* (19'8")
Profile Track	1 x 1.00m	1 x 1.50m	1 x 2.00m	1 x 2.50m	2 x 1.50m	2 x 2.00m	2 x 2.50m	2 x 3.00m
Brackets**	3	4	5	6	7	9	11	13
End Caps	2	2	2	2	2	2	2	2
Gliders^	10	16	20	26	30	40	50	60
Twist End Stops	2	2	2	2	2	2	2	2
Standard Glider Kit Code †	16CPUS100_	16CPUS150_	16CPUS200_	16CPUS250_	16CPUS300_	16CPUS400_	16CPUS500_	16CPUS600_
60mm SurgeWave Kit Code †	16CPU6100_	16CPU6150_	16CPU6200_	16CPU6250_	16CPU6300_	16CPU6400_	16CPU6500_	16CPU6600_
80mm SurgeWave Kit Code †	16CPU8100_	16CPU8150_	16CPU8200_	16CPU8250_	16CPU8300_	16CPU8400_	16CPU8500_	16CPU8600_

Packed: 1 px / Outer 5 Min Qty: 1 † Insert your chosen colour letter reference at end of the Kit code.

NOTE: Kits come with 10 gliders per m unless otherwise specified.

* Denotes 2 piece profile with joiner. All kits include fittings.

** Standard Glider Kits = 4cm Leverlock Wall/Ceiling Brackets • 60mm SurgeWave Kits = 6cm Wall/Ceiling Leverlock Brackets • 80mm SurgeWave Kits = 8cm Leverlock Brackets

^ For SurgeWave Kits the gliders are replaced with SurgeWave Gliders-on-a-string – see p176–177 to calculate the number of SurgeWave Gliders required.



This curtain track is suitable for light-to-medium weight curtains

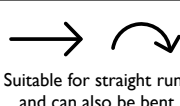

DISCLAIMER: Whilst every effort has been made to ensure colour accuracy, due to the limitations of colour printing, please refer to product samples for colour matching. Product dimensions are for guidance only and may differ – please confirm details at time of ordering.

Professional Large Curved Aluminium Profile Track

Professional Large Curved Aluminium Profile Track – Complete Kits

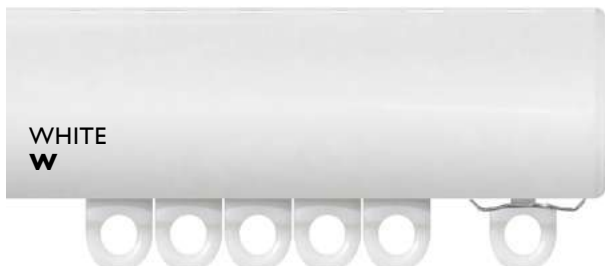
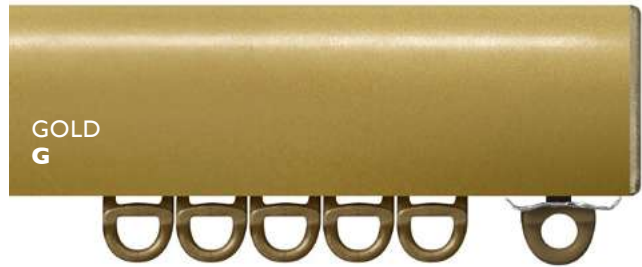

Professional Large Curved Profile Track Kit Components

NOTE: Kits are available up to the size ordered and can also be produced to your specific size.

Components	Track Kit Sizes							
	1.00m (3'3")	1.50m (4'11")	2.00m (6'7")	2.50m (8'2")	3.00m* (9'10")	4.00m* (13'1")	5.00m* (16'5")	6.00m* (19'8")
Profile Track	1 x 1.00m	1 x 1.50m	1 x 2.00m	1 x 2.50m	2 x 1.50m	2 x 2.00m	2 x 2.50m	2 x 3.00m
Brackets**	3	4	5	6	7	9	11	13
End Caps	2	2	2	2	2	2	2	2
Gliders^	10	16	20	26	30	40	50	60
Twist End Stops	2	2	2	2	2	2	2	2
Standard Glider Kit Code †	16CPUS100_	16CPUS150_	16CPUS200_	16CPUS250_	16CPUS300_	16CPUS400_	16CPUS500_	16CPUS600_
60mm SurgeWave Kit Code †	16CPU6100_	16CPU6150_	16CPU6200_	16CPU6250_	16CPU6300_	16CPU6400_	16CPU6500_	16CPU6600_
80mm SurgeWave Kit Code †	16CPU8100_	16CPU8150_	16CPU8200_	16CPU8250_	16CPU8300_	16CPU8400_	16CPU8500_	16CPU8600_

Packed: 1 px / Outer 5 Min Qty: 1 † Insert your chosen colour letter reference at end of the Kit code.

NOTE: Kits come with 10 gliders per m unless otherwise specified.

* Denotes 2 piece profile with joiner. All kits include fittings.

** Standard Glider Kits = 4cm Leverlock Wall/Ceiling Brackets • 60mm SurgeWave Kits = 6cm Wall/Ceiling Leverlock Brackets • 80mm SurgeWave Kits = 8cm Leverlock Brackets

^For SurgeWave Kits the gliders are replaced with SurgeWave Gliders-on-a-string – see p176-177 to calculate the number of SurgeWave Gliders required.



This curtain track is suitable for light-to-medium weight curtains



Suitable for straight runs and can also be bent



Kits/components are delivered in transport or retail packaging



Available in contract components for large jobs



Available in kit form for simple ordering



Tracks available made-to-measure

DISCLAIMER: Whilst every effort has been made to ensure colour accuracy, due to the limitations of colour printing, please refer to product samples for colour matching. Product dimensions are for guidance only and may differ – please confirm details at time of ordering.

Professional Large Curved Aluminium Profile Track – Accessories

Brackets



Ceiling Standard Bracket (with Slot)

White Code: 16HSBCCW
Packed: 100 Min Qty: 100



Ceiling Standard Bracket (with Hole)

White Code: 16HSBHCW
Black Code: 16HSBHCK
Packed: 100 Min Qty: 100



4cm Standard Wall/Ceiling Bracket

White Code: 16HSB4CW
Packed: 100 Min Qty: 100



6cm Standard Wall/Ceiling Bracket

White Code: 16HSB6CW
Packed: 100 Min Qty: 100



3cm Click Wall/Ceiling Bracket

White Code: 16HSC3CW
Packed: 100 Min Qty: 100



4cm Click Wall/Ceiling Bracket

White Code: 16HSC4CW
Packed: 100 Min Qty: 100



5cm Click Wall/Ceiling Bracket

White Code: 16HSC5CW
Packed: 100 Min Qty: 100



4cm Leverlock Wall/Ceiling Bracket

White Code: 16HSL4CW
Grey Code: 16HSL4CT
Black Code: 16HSL4CK
Gold Code: 16HSL4CG



Packed: 100 Min Qty: 100

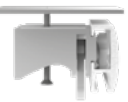

5cm Leverlock Wall/Ceiling Bracket

White Code: 16HSL5CW
Grey Code: 16HSL5CT
Black Code: 16HSL5CK
Gold Code: 16HSL5CG



Packed: 100 Min Qty: 100



6cm Leverlock Wall/Ceiling Bracket

White Code: 16HSL6CW
Grey Code: 16HSL6CT
Black Code: 16HSL6CK
Gold Code: 16HSL6CG



Packed: 100 Min Qty: 100



8cm Leverlock Wall/Ceiling Bracket

White Code: 16HSL8CW
Grey Code: 16HSL8CT
Black Code: 16HSL8CK
Gold Code: 16HSL8CG



Packed: 100 Min Qty: 100



Brackets



Ceiling Leverlock Bracket (with Hole)

White Code: 16HSLCCW
Grey Code: 16HSLCCT
Black Code: 16HSLCCK
Gold Code: 16HSLCCG



Packed: 100 Min Qty: 100



Flush Wall Fix Bracket

White Code: 16HSFBCW
Packed: 100 Min Qty: 100



Professional Large Curved Profile Recess Bracket

Transparent Code: 16CPRBCO
Packed: 100 Min Qty: 10

L-Extension Brackets can be used with tracks and blinds to increase the projection from the wall to the desired length. Covers are also available for a neat finish. See page 110.



3cm L-Extension Bracket

White Code: 16LB031W
Packed: 10 Min Qty: 10



9cm L-Extension Bracket

White Code: 16LB091W
Silver Code: 16LB091S
Black Code: 16LB091K
Packed: 10 Min Qty: 10



14cm L-Extension Bracket

White Code: 16LB141W
Packed: 10 Min Qty: 10

Screw for Double Track use Code: 16LSSCREW Packed: 10 Min Qty: 10



Ceiling Suspension Hanger Kit Ø8mm Tube

White Size: 100cm (3'3") Code: 16CS101W
White Size: 150cm (4'11") Code: 16CS151W

Packed: 1 Min Qty: 1
Note: These can be cut to the required drop

Suitable to work with any bracket or track with ceiling fix option to create distance between the ceiling and the track.



Joiners



H-Section Profile Joiner

Works with Optimal, Principal (White ONLY), Professional & Heavy Duty H-Section Tracks

Code: 16HSJODW

Packed: 10 Min Qty: 10



Professional Large Curved Profile Joint Cover

Gold Code: 16CPJCCG
White Code: 16CPJCCW
Dark Grey Code: 16CPJCCD
Light Grey Code: 16CPJCCL
Black Code: 16CPJCCK
Antique Brass Code: 16CPJCCQ
Sand Code: 16CPJCCC

Packed: 100 Min Qty: 100

DISCLAIMER: Whilst every effort has been made to ensure colour accuracy, due to the limitations of colour printing, please refer to product samples for colour matching. Product dimensions are for guidance only and may differ – please confirm details at time of ordering.

Professional Large Curved Aluminium Profile Track – Accessories

Gliders & Glider Accessories



Standard 4mm Gliders Strips of 20 (20 x 50)

	White	Code: 16HSSGKW
	Grey	Code: 16HSSGKT
	Black	Code: 16HSSGKK
	Gold	Code: 16HSSGKG
Packed: 1000		Min Qty: 1000



Click-In Gliders for 4mm Channel

	White	Code: 16HSCGKW
Packed: 1000		Min Qty: 100



Metal Overlap Arm for 4mm Channel

	White	Code: 16HSOLIW
Packed: 10		Min Qty: 10



Metal Underlap Arm for 4mm Channel

	White	Code: 16HSULIW
Packed: 10		Min Qty: 10

These Glider Attachments can be added to gliders with an 'eye' to connect to curtains



	Plastic S-Hook	Code: 16HO995W
Packed: 1000		Min Qty: 1000

	Large Metal S-Hook 39mm	Code: 16HO072S
	Small Metal S-Hook 29mm	Code: 16HO071S
Packed: 100		Min Qty: 100

SurgeWave® System Gliders & Accessories

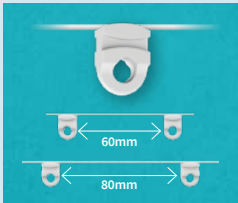

SurgeWave® System Gliders-on-a-String for 4mm Channel

	White	Spacing: 60mm	Code: 16HS60GLST
	White	Spacing: 80mm	Code: 16HS80GLST
	Black	Spacing: 60mm	Code: 16HS60GLSK
	Black	Spacing: 80mm	Code: 16HS80GLSK
Packed: 25m		Min Qty: 25m	



SurgeWave® System Curtain Tape

With 60mm & 80mm Spacing Guides

	White	Packed: 50m	Code: 51TOWA3R
	White	Packed: 100m	Code: 51TOWA3CR
	Black	Packed: 50m	Code: 51TOWAK3R
Min Qty: 100m			



Iron-on SurgeWave® System Curtain Tape

	White	Packed: 50m	Code: 51TOWIA3R
Min Qty: 100m			

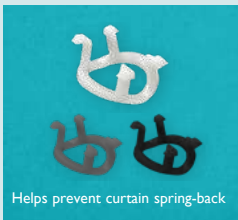

Friction Gliders for SurgeWave® System

	White	Packed: 10	Code: 16HSFGDW
	White	Packed: 100	Code: 16HSFGCW
	Grey	Packed: 10	Code: 16HSFGDT
	Grey	Packed: 100	Code: 16HSFGCT
	Black	Packed: 10	Code: 16HSFGDK
	Black	Packed: 100	Code: 16HSFGCK

Helps prevent curtain spring-back



Neat Pleat Guide for SurgeWave® System

Clips onto 4mm & 6mm SurgeWave Gliders

	White	Code: 16SURNP-
Packed: 10		Min Qty: 10

For more details on how the SurgeWave® System works please see pages 165–180 in this Catalogue



End Caps & End Stops



Professional Large Curved Profile End Caps

	White	Code: 16CPECCW
	Silver	Code: 16CPECCCT
	Black	Code: 16CPECCCK
	Antique Brass	Code: 16CPECCQ
	Silver Metallic	Code: 16CPECCS
	Anthracite	Code: 16CPECCA
	Gold	Code: 16CPECCG
	Sand	Code: 16CPECCC
Packed: 100		Min Qty: 100



Twist-Fit End Stop for 4mm Channel

	White	Code: 16HSESCW
	Black	Code: 16HSESCK
	Grey	Code: 16HSESCCT
	Gold	Code: 16HSESCG
Packed: 100		Min Qty: 100



Metal Twist Stop for 4mm Channel

	Silver	Code: 16HSTSCS
Packed: 100		Min Qty: 100

Bends & Bending Tools



Table Mounted Bending Tool for Mini Professional Small Curved Profile & Professional Large Curved Profile (includes 1 set of bending inserts)

Code: 16CPPBEN	
Packed: 1	Min Qty: 1
Internal and external bends can be formed	



Large Portable Bending Tool for Optimal H-Section, Principal H-Section, Professional Large Curved Profile, W-Section Profile, Heavy Duty H-Section Profile and Cubicle Rail (includes 1 set of bending inserts)

Code: 16MPLBEN	
Packed: 1	Min Qty: 1



Spare Bending Insert Sets (2-piece)

Insert into the glider and bracket channel of aluminium track to prevent damage to the channel whilst bending	
Code: 16CPINST	
Packed: 1	Min Qty: 1



Made-to-Measure Cutting Service

Code: 16MTMTRK

Professional Track Bending Service:

Single Angle Bend	Code: 16CPBEND
Continuous Curve	Code: 16CPCONT



Please see page 227 for the Renaissance Metal Track Bending Form

DISCLAIMER: Whilst every effort has been made to ensure colour accuracy, due to the limitations of colour printing, please refer to product samples for colour matching. Product dimensions are for guidance only and may differ – please confirm details at time of ordering.

Mini U-Section

Aluminium Profile Track

Discreet ceiling and wall mounted curtain rails where a minimal sized track is required to optimise and blend with discretion.

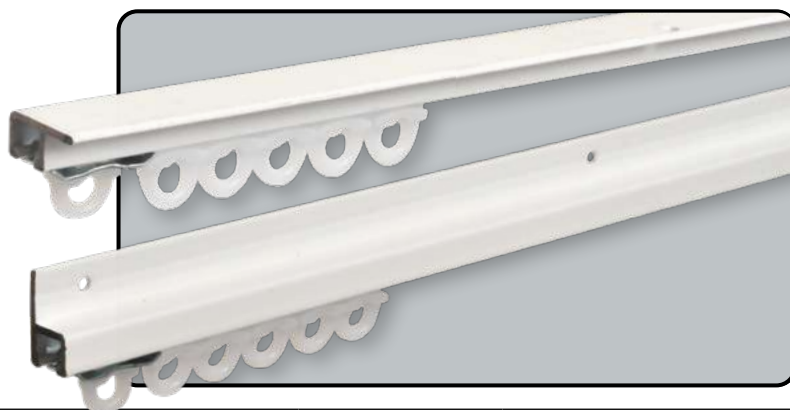

Top Fix U-Section ONLY



For Curtain Hooks see this Catalogue page 217



Mini U-Section Aluminium Profile Track – Top Fix 4mm Channel
Predrilled with holes

Size: 6m (19'8") White Code: 16UT600W

Packed: 10 Lengths Min Qty: 10 *Special order only

125mm between predrilled holes

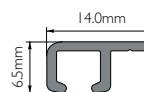

Colour finish available:

WHITE
RAL 9016

Profile Weight: 74g/m

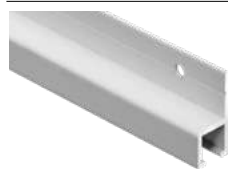

Mini U-Section Aluminium Profile Track – Wall Fix 4mm Channel
Predrilled with holes

Size: 6m (19'8") White Code: 16UW600W

Packed: 10 Lengths Min Qty: 10 *Special order only

125mm between predrilled holes. This track is NOT SurgeWave Compatible.

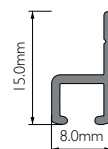

Colour finish available:

WHITE
RAL 9016

Profile Weight: 74g/m

Made-to-measure Kits include Track, Brackets, Gliders & End Stops. An essential time saver for the professional fitter – see the table below for details.

Top Fix and Wall Fix

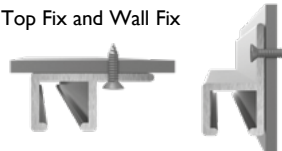

**NO BRACKETS
REQUIRED!**

Mini U-Section Aluminium Profile Track Kit White Components

NOTE: Kits are available up to the size ordered and can also be produced to your specific size.

Components	Track Kit Sizes							
	1.00m (3'3")	1.50m (4'11")	2.00m (6'7")	2.50m (8'2")	3.00m* (9'10")	4.00m* (13'1")	5.00m* (16'5")	6.00m* (19'8")
Profile Track	1 x 1.00m	1 x 1.50m	1 x 2.00m	1 x 2.50m	2 x 1.50m	2 x 2.00m	2 x 2.50m	2 x 3.00m
Gliders [^]	10	16	20	26	30	40	50	60
Twist End Stops	2	2	2	2	2	2	2	2

Top Fix

Standard Glider Kit Code †	16UTUS100W	16UTUS150W	16UTUS200W	16UTUS250W	16UTUS300W	16UTUS400W	16UTUS500W	16UTUS600W
60mm SurgeWave Kit Code †	16UTU6100W	16UTU6150W	16UTU6200W	16UTU6250W	16UTU6300W	16UTU6400W	16UTU6500W	16UTU6600W
80mm SurgeWave Kit Code †	16UTU8100W	16UTU8150W	16UTU8200W	16UTU8250W	16UTU8300W	16UTU8400W	16UTU8500W	16UTU8600W

Wall Fix

Standard Glider Kit Code †	16UWUS100W	16UWUS150W	16UWUS200W	16UWUS250W	16UWUS300W	16UWUS400W	16UWUS500W	16UWUS600W
----------------------------	------------	------------	------------	------------	------------	------------	------------	------------

Packed: 1 px/Outer 5 Min Qty: 1

* Denotes 2 piece profile. All kits include fittings.

[^]For SurgeWave Kits the gliders are replaced with SurgeWave Gliders-on-a-string – see p176-177 to calculate the number of SurgeWave Gliders required.

NOTE: Kits come with 10 gliders per m unless otherwise specified.



This curtain track is suitable for light weight curtains



Suitable for straight runs ONLY



Kits/components are delivered in transport packaging



Available in contract components for large jobs



Available in kit form for simple ordering



Tracks available made-to-measure

DISCLAIMER: Whilst every effort has been made to ensure colour accuracy, due to the limitations of colour printing, please refer to product samples for colour matching. Product dimensions are for guidance only and may differ – please confirm details at time of ordering.

Mini U-Section Aluminium Profile Track – Accessories

End Stops



Twist-Fit End Stop for 4mm Channel
 White Code: 16HSESCW
 Packed: 100 Min Qty: 100



Metal Twist Stop for 4mm Channel
 Silver Code: 16HSTSCS
 Packed: 100 Min Qty: 100

Gliders & Glider Accessories



Standard Gliders for 4mm Channel
 Strips of 20 (20 x 50)
 White Code: 16HSSGKW
 Packed: 1000 Min Qty: 1000



Click-In Gliders for 4mm Channel
 White Code: 16HSCGKW
 Packed: 1000 Min Qty: 100



Metal Overlap Arm for 4mm Channel
 White Code: 16HSOL1W
 Packed: 10 Min Qty: 10



Metal Underlap Arm for 4mm Channel
 White Code: 16HSUL1W
 Packed: 10 Min Qty: 10

These Glider Attachments can be added to gliders with an 'eye' to connect to curtains



Plastic S-Hook Code: 16HO995W
 Packed: 1000 Min Qty: 1000

Large Metal S-Hook 39mm Code: 16HO072S
Small Metal S-Hook 29mm Code: 16HO071S
 Packed: 100 Min Qty: 100

SurgeWave® System Gliders & Accessories



SurgeWave® System Gliders-on-a-String
 for 4mm Channel
 Spacing: 60mm Code: 16HS60GLST
 Spacing: 80mm Code: 16HS80GLST
 Packed: 25m Min Qty: 25m



SurgeWave® System Curtain Tape
 With 60mm & 80mm Spacing Guides
 White Packed: 50m Code: 51TOWA3R
 White Packed: 100m Code: 51TOWA3CR
 Black Packed: 50m Code: 51TOWAK3R
 Min Qty: 100m



Iron-on SurgeWave® System Curtain Tape
 White Packed: 50m Code: 51TOWIA3R
 Min Qty: 100m



Friction Gliders for SurgeWave® System
 White Packed: 1 Code: 16HSFG1W
 White Packed: 10 Code: 16HSFGDW
 White Packed: 100 Code: 16HSFGCW

Helps prevent curtain spring-back



Neat Pleat Guide for SurgeWave® System
 Clips onto 4mm & 6mm SurgeWave Gliders
 White Code: 16SURNP-
 Packed: 10 Min Qty: 10

For more details on how the SurgeWave® System works please see pages 165–180 in this Catalogue



W-Section

Aluminium Profile Track

An unobtrusive and discreet low profile aluminium track capable of managing heavier curtains with a low profile visual impact. Can be ceiling or wall mounted.



For Curtain Hooks see this Catalogue page 217

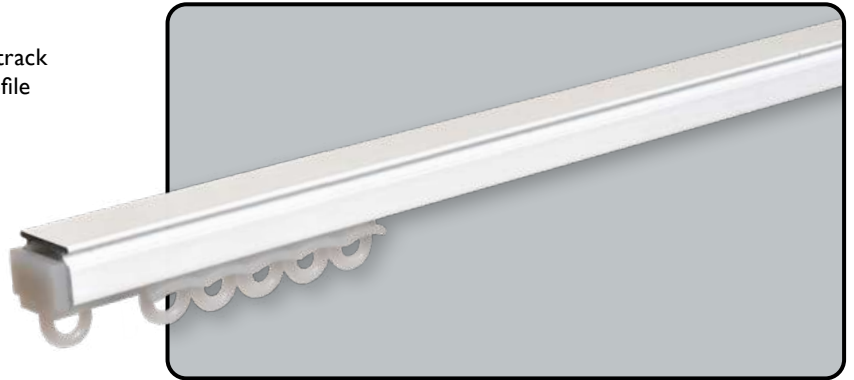
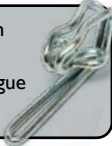

Profile Weight: 116g/m

W-Section Aluminium Profile Track 6mm Channel
Predrilled with holes†
With 220mm spacing between holes

Size: 6m (19'8") White Code: I6WH600W
Size: 6m (19'8") Black Code: I6WH600K
Packed: 10 Lengths Min Qty: 10

†NOTE: W-Section Predrilled Profile is NOT Surge compatible

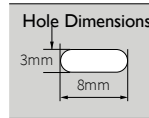
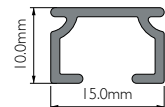

Colour finishes available:

WHITE W
RAL 9016

BLACK K
RAL 9005

Insert your chosen colour letter reference at end of the Kit Code.



W-Section Aluminium Profile Track 6mm Channel

Size: 6m (19'8") White Code: I6WS600W
Size: 6m (19'8") Black Code: I6WS600K
Packed: 10 Lengths Min Qty: 10

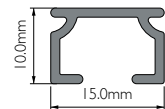

FIXING TIP: Screw Type

We suggest using screws with a 3.5mm diameter screw shank and head diameter of 6.0mm or less

Made-to-measure Kits include non-drilled profile Track, Ceiling Brackets, Gliders and End Caps. An essential time saver for professional fitters – see table below for details.

Ceiling Fix Bracket



How it works: Wall fix option

To wall fix W-Section Track simply add an L-Extension Bracket to W-Section Profile Ceiling Fix Bracket as shown here

L-Extension Bracket available sizes: 3cm, 9cm and 14cm

For wall fix kits please add your chosen L-Extension Brackets as a separate item at time of order. For predrilled Kits without ceiling brackets please specify at time of order.



W-Section Aluminium Profile Track Kit Components

NOTE: Kits are available up to the size ordered and can also be produced to your specific size.

Components	Track Kit Sizes							
	1.00m (3'3")	1.50m (4'11")	2.00m (6'7")	2.50m (8'2")	3.00m* (9'10")	4.00m* (13'1")	5.00m* (16'5")	6.00m* (19'8")
Non-drilled Profile Track	1 x 1.00m	1 x 1.50m	1 x 2.00m	1 x 2.50m	2 x 1.50m	2 x 2.00m	2 x 2.50m	2 x 3.00m
Ceiling Brackets	3	4	5	6	7	9	11	13
End Caps	2	2	2	2	2	2	2	2
Gliders^	10	16	20	26	30	40	50	60
Standard Glider Kit Code †	16WSUS100_	16WSUS150_	16WSUS200_	16WSUS250_	16WSUS300_	16WSUS400_	16WSUS500_	16WSUS600_
60mm SurgeWave Kit Code †	16WSU6100_	16WSU6150_	16WSU6200_	16WSU6250_	16WSU6300_	16WSU6400_	16WSU6500_	16WSU6600_
80mm SurgeWave Kit Code †	16WSU8100_	16WSU8150_	16WSU8200_	16WSU8250_	16WSU8300_	16WSU8400_	16WSU8500_	16WSU8600_
Surge Ribbon 60 Kit Code †	16WSURB6100_	16WSURB6150_	16WSURB6200_	16WSURB6250_	16WSURB6300_	16WSURB6400_	16WSURB6500_	16WSURB6600_
Surge Ribbon 60 Kit Code †	16WSURB8100_	16WSURB8150_	16WSURB8200_	16WSURB8250_	16WSURB8300_	16WSURB8400_	16WSURB8500_	16WSURB8600_

Packed: 1 px / Outer 5 Min Qty: 1

NOTE: Kits come with 10 gliders per m unless otherwise specified.

† Insert your chosen colour letter reference at end of the Kit Code.

* Denotes 2 piece profile with joiner. All kits include fittings.

^ For SurgeWave Kits the gliders are replaced with SurgeWave Gliders-on-a-string or SurgeWave Ribbon Gliders – see p176-177 to calculate the number of SurgeWave Gliders required.

NOTE: All Kits include Ceiling Brackets (for wall fix please add your chosen L-Extension bracket to your order). Predrilled Profile Kits also available but do not include Brackets.



This curtain track is suitable for light-to-medium weight curtains

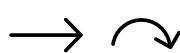

Suitable for straight runs
Can be bent (not Predrilled)



Kits/components are delivered in transport packaging



Available in contract components for large jobs



Available in kit form for simple ordering



Tracks available made-to-measure

DISCLAIMER: Whilst every effort has been made to ensure colour accuracy, due to the limitations of colour printing, please refer to product samples for colour matching. Product dimensions are for guidance only and may differ – please confirm details at time of ordering.

W-Section Aluminium Profile Track – Accessories

Brackets



W-Section Profile Ceiling Bracket

- White Code: 16WSB-I-
- Black Code: 16WSB-1K

Packed: 10 Min Qty: 10



Suspended Ceiling Bracket

Used with tracks or blinds to fix to suspended ceilings.

- White Code: 16HSSCCW

Packed: 100 Min Qty: 10

L-Extension Brackets can be used with tracks and blinds to increase the projection from the wall to the desired length. Covers are also available for a neat finish. See page 110.



3cm L-Extension Bracket

- White Code: 16LB031W

Packed: 10 Min Qty: 10



9cm L-Extension Bracket

- White Code: 16LB091W

- Black Code: 16LB091K

Packed: 10 Min Qty: 10



14cm L-Extension Bracket

- White Code: 16LB141W

Packed: 10 Min Qty: 10



Screw for Double Track use Code: 16LSSCREW Packed: 10 Min Qty: 10



L-Extension Bracket Cover

A one-size-fits all solution for any size L-Extension Bracket – simply snap-off to fit to size.

- White Code: 16LBCOVW

- Black Code: 16LBCOVK

Packed: 10 Min Qty: 10

End Stops



Plastic End Stopper with Screw and Eye for 6mm Channel

- White Code: 16HO743W

- Black Code: 16HO743K

Packed: 100 Min Qty: 100



Large Metal Mid Stop for 6mm Channel

- Silver Code: 16HO044S

Packed: 100 Min Qty: 100



Large Twist-Fit End Stop for 6mm Channel

- White Code: 16HO744W

- Black Code: 16HO744K

Packed: 100 Min Qty: 100



Large Metal Twist Stop for 6mm Channel

- Silver Code: 16HO997S

Packed: 100 Min Qty: 100

Joiner



W-Section Profile Joiner

- White Code: 16WSJODW

Packed: 10 Min Qty: 10

Gliders & Glider Accessories



Standard Gliders – strips of 10 6mm Channel

- White Code: 16HO738W
- Black Code: 16HO738K

Packed: 2000 Min Qty: 1000



Caragliders – strips of 10 for 6mm Channel

- White Code: 16HO999W

Packed: 1000 Min Qty: 1000



Heavy Duty Gliders for 6mm Channel

- White Code: 16HD307W

Packed: 100 Min Qty: 10



Click-in Glider for 6mm Channel

- White Code: 16HO998W

Packed: 1000 Min Qty: 1000



Standard Gliders with Large Metal S-Hook

- White Code: 16HO996W

Packed: 100 Min Qty: 100

Standard Gliders with Small Metal S-Hook

- White Code: 16HO990W

Packed: 100 Min Qty: 100



Caragliders with Large Metal S-Hook

- White Code: 16HO994W

Packed: 100 Min Qty: 100

Caragliders with Large Plastic S-Hook

- White Code: 16HO991W

Packed: 100 Min Qty: 100

These Glider Attachments can be added to gliders with an 'eye' to connect to curtains



Plastic S-Hook Code: 16HO995W

Packed: 1000 Min Qty: 1000

Large Metal S-Hook 39mm Code: 16HO072S

Small Metal S-Hook 29mm Code: 16HO071S

Packed: 100 Min Qty: 100

Overlap Arms



6mm Overlap Arm (Inc. Cord Carrier)

Compatible with all gliders except for Heavy Duty

- Silver Code: 16WSOLI-

Packed: 1 Min Qty: 1



Heavy Duty Underlap Arm ^Δ 6mm Channel

- White Code: 16HD301W

Packed: 10 Min Qty: 10



Heavy Duty Overlap Arm ^Δ 6mm Channel

- White Code: 16HD303W

Packed: 10 Min Qty: 10

^Δ Compatible when using Heavy Duty Gliders **ONLY**

DISCLAIMER: Whilst every effort has been made to ensure colour accuracy, due to the limitations of colour printing, please refer to product samples for colour matching. Product dimensions are for guidance only and may differ – please confirm details at time of ordering.

W-Section Aluminium Profile Track – Accessories

SurgeWave® System Gliders & Accessories

PLEASE NOTE: SurgeWave Gliders are NOT compatible Pre-Drilled W-Section

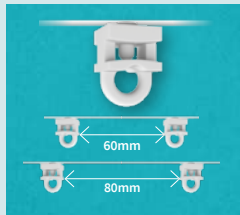

SurgeWave® System Gliders-on-a-String for 6mm Channel

- White Spacing: 60mm Code: I6HH60GLST
 - White Spacing: 80mm Code: I6HH80GLST
 - Black Spacing: 60mm Code: I6HH60GLSK
 - Black Spacing: 80mm Code: I6HH80GLSK
- Packed: 25m Min Qty: 25m

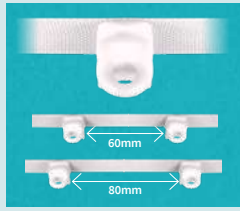

SurgeWave® System Ribbon Gliders for 6mm Channel

- White Spacing: 60mm Code: I6SW6RG60W
 - White Spacing: 80mm Code: I6SW6RG80W
 - Black Spacing: 60mm Code: I6SW6RG60K
 - Black Spacing: 80mm Code: I6SW6RG80K
- Packed: 25m Min Qty: 25m



SurgeWave® Roller Gliders-on-a-String (Narrow) for 6mm Channel

- White Spacing: 60mm Code: I6GL6SR60W
 - White Spacing: 80mm Code: I6GL6SR80W
- Packed: 30m Min Qty: 30m



SurgeWave® System Curtain Tape With 60mm & 80mm Spacing Guides

- White Packed: 50m Code: 51TOWA3R
 - White Packed: 100m Code: 51TOWA3CR
 - Black Packed: 50m Code: 51TOWAK3R
- Min Qty: 100m



Iron-on SurgeWave® System Curtain Tape

- White Packed: 50m Code: 51TOWIA3R
- Min Qty: 100m

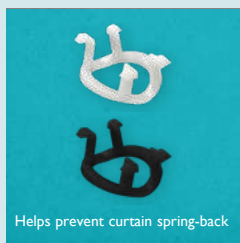

Friction Gliders for SurgeWave® System
NOTE: Not compatible with Ribbon Gliders

- White Packed: 10 Code: I6HSFGDW
- White Packed: 100 Code: I6HSFGCW
- Black Packed: 10 Code: I6HSFGDK
- Black Packed: 100 Code: I6HSFGCK

Helps prevent curtain spring-back



Neat Pleat Guide for SurgeWave® System
Clips onto 4mm & 6mm SurgeWave Gliders

- White Code: I6SURNP-
- Packed: 10 Min Qty: 10

For more details on how the SurgeWave® System works please see pages 165–180 in this Catalogue



Bending



Table Mounted Bending Tool for Optimal H-Section, Principal H-Section & W-Section Profile (includes 1 set of bending inserts)

Internal & external bends can be formed
Code: I6HSPBEN Packed: 1 Min Qty: 1



Large Portable Bending Tool for Optimal H-Section, Principal H-Section, Professional Large Curved Profile, W-Section Profile, Heavy Duty H-Section Profile and Cubicle Rail (includes 1 set of bending inserts)

Code: I6MPLBEN
Packed: 1 Min Qty: 1

Internal and external bends can be formed



Spare Bending Insert Sets (2-piece)

Insert into the glider and bracket channel of aluminium track to prevent damage to the channel whilst bending

Code: I6WSINST Packed: 1 Min Qty: 1



Made-to-Measure Cutting Service

Code: I6MTMTRK

W-Section Track Bending Service:

Single Angle Bend

Code: I6WSBEND

Continuous Curve

Code: I6WSCONT

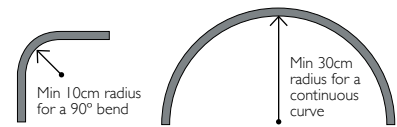

Please see page 227 for the Renaissance Metal Track Bending Form

Recess M-Section Aluminium Profile Track

A heavy duty aluminium track designed to be recessed into plasterboard ceilings and directly fixed to trusses. Also works with SurgeWave® Ribbon Gliders.

Recess M-Section is also ideal for use as side channel guides for Roller Blinds.

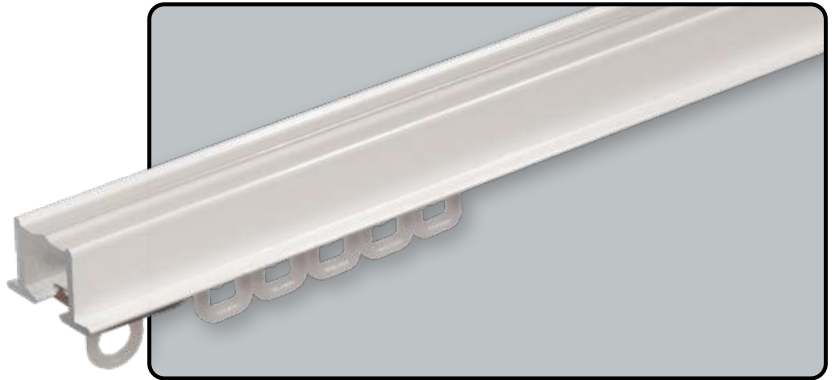

For Curtain Hooks see this Catalogue page 217



Recess M-Section Aluminium Profile Track 6mm Channel

Size: 6m (19'8")

White

Code: I6RMS600W

Packed: 10 Lengths

Min Qty: 10

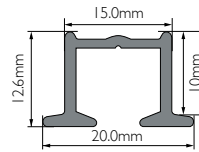

Colour finish available:
WHITE
RAL 9016

Profile Weight: 154g/m

Made-to-measure Kits include Track, Gliders and End Stops. It's an essential time saver for professional fitters – please see the table below for details.

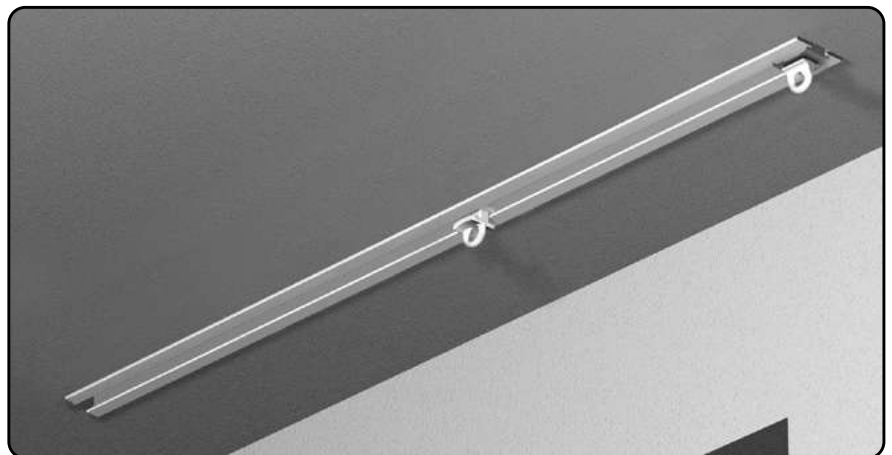

FIXING TIP: Screw Type
We suggest using screws with a 3mm diameter screw shank and head diameter of 5.6mm or less. Length required will depend on the substrate you are fixing the track to.

Recess M-Section Aluminium Profile Track Kit Components

NOTE: Kits are available up to the size ordered and can also be produced to your specific size.

Components	Track Kit Sizes							
	1.00m (3'3")	1.50m (4'11")	2.00m (6'7")	2.50m (8'2")	3.00m* (9'10")	4.00m* (13'1")	5.00m* (16'5")	6.00m* (19'8")
Profile Track	1 x 1.00m	1 x 1.50m	1 x 2.00m	1 x 2.50m	2 x 1.50m	2 x 2.00m	2 x 2.50m	2 x 3.00m
End Stops	2	2	2	2	2	2	2	2
Gliders [^]	10	16	20	26	30	40	50	60
Standard Glider Kit Code	16RMUS100W	16RMUS150W	16RMUS200W	16RMUS250W	16RMUS300W	16RMUS400W	16RMUS500W	16RMUS600W
Surge Ribbon 60 Kit Code	16RMURB6100W	16RMURB6150W	16RMURB6200W	16RMURB6250W	16RMURB6300W	16RMURB6400W	16RMURB6500W	16RMURB6600W
Surge Ribbon 80 Kit Code	16RMURB8100W	16RMURB8150W	16RMURB8200W	16RMURB8250W	16RMURB8300W	16RMURB8400W	16RMURB8500W	16RMURB8600W

Packed: 1 px/Outer 5 Min Qty: 1

NOTE: Kits come with 10 gliders per m unless otherwise specified.

*Track supplied in 2 pieces – unless specified

[^]For SurgeWave Kits the gliders are replaced with SurgeWave Ribbon Gliders – see p176-177 to calculate the number of SurgeWave Gliders required.

<p>This curtain track is suitable for light-to-medium weight curtains</p>	<p>Suitable for straight runs Can also be bent**</p>	<p>Kits/components are delivered in transport packaging</p>	<p>Available in contract components for large jobs</p>	<p>Available in kit form for simple ordering</p>	<p>Tracks available made-to-measure</p>
---	--	---	--	--	---

** For bending requirements please enquire with our Sales Team.

DISCLAIMER: Whilst every effort has been made to ensure colour accuracy, due to the limitations of colour printing, please refer to product samples for colour matching. Product dimensions are for guidance only and may differ – please confirm details at time of ordering.

Recess M-Section Aluminium Profile Track – Accessories

End Stops



Large Metal Mid Stop for 6mm Channel
 Silver Code: 16HO044S
 Packed: 100 Min Qty: 100



Large Twist-Fit End Stop for 6mm Channel
 White Code: 16HO744W
 Packed: 100 Min Qty: 100



Large Metal Twist Stop for 6mm Channel
 Silver Code: 16HO997S
 Packed: 100 Min Qty: 100

Overlap Arms



Overlap Arm for 6mm Channel
 Compatible with all gliders except for Heavy Duty
 Silver Code: 16WSOLI-
 Packed: 1 Min Qty: 1



Heavy Duty Underlap Arm ^Δ 6mm Channel
 White Code: 16HD301W
 Packed: 10 Min Qty: 10



Heavy Duty Overlap Arm ^Δ 6mm Channel
 White Code: 16HD303W
 Packed: 10 Min Qty: 10
^Δ Compatible when using Heavy Duty Gliders **ONLY**

Gliders & Accessories



Standard Gliders – strips of 10 6mm Channel
 White Code: 16HO738W
 Packed: 2000 Min Qty: 1000



Roller Gliders – Strips of 10 for 6mm Channel
 White Packed: 100 Code: 16HO025W
 White Packed: 1000 Code: 16HO025KW
 Min Qty: 100



Caragliders – strips of 10 for 6mm Channel
 White Code: 16HO999W
 Packed: 1000 Min Qty: 1000



Heavy Duty Gliders for 6mm Channel
 White Code: 16HD307W
 Packed: 100 Min Qty: 10



Click-in Glider for 6mm Channel
 White Code: 16HO998W
 Packed: 1000 Min Qty: 1000



Standard Gliders with Large Metal S-Hook
 White Code: 16HO996W
 Packed: 100 Min Qty: 100

Standard Gliders with Small Metal S-Hook
 White Code: 16HO990W
 Packed: 100 Min Qty: 100



Caragliders with Large Metal S-Hook
 White Code: 16HO994W
 Packed: 100 Min Qty: 100

Caragliders with Large Plastic S-Hook
 White Code: 16HO991W
 Packed: 100 Min Qty: 100

SurgeWave® System Gliders & Accessories

NOTE: We do not recommend using SurgeWave® standard 6mm Gliders-on-a-string or SurgeWave Roller Gliders with Recess M-Section

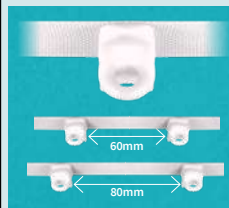

SurgeWave® System Ribbon Gliders for 6mm Channel
 White Spacing: 60mm Code: 16SW6RG60W
 White Spacing: 80mm Code: 16SW6RG80W
 Packed: 25m Min Qty: 25m



SurgeWave® Click-In End Lock 6mm Channel
 Clear Code: 16SUESCW
 Packed: 100 Min Qty: 100



SurgeWave® System Curtain Tape
 With 60mm & 80mm Spacing Guides
 White Packed: 50m Code: 51TOWA3R
 White Packed: 100m Code: 51TOWA3CR
 Black Packed: 50m Code: 51TOWAK3R
 Min Qty: 100m



Iron-on SurgeWave® System Curtain Tape
 White Packed: 50m Code: 51TOWIA3R
 Min Qty: 100m



Neat Pleat Guide for SurgeWave® System
 Clips onto 4mm & 6mm SurgeWave Gliders
 White Code: 16SURNP-
 Packed: 10 Min Qty: 10

For more details on how the SurgeWave® System works please see pages 165–180 in this Catalogue



Bending



Made-to-Measure Cutting Service
 Code: 16MTMTRK

Recess M-Section Track Bending Service:
 Please enquire with our Sales Team.

Please see page 227 for the Renaissance Metal Track Bending Form

DISCLAIMER: Whilst every effort has been made to ensure colour accuracy, due to the limitations of colour printing, please refer to product samples for colour matching. Product dimensions are for guidance only and may differ – please confirm details at time of ordering.

L-Section

Aluminium Profile Track

A heavy-duty direct-to-ceiling fix curtain track. The discreet profile design has evenly spaced pre-drilled holes for quick and easy installation with no brackets required.

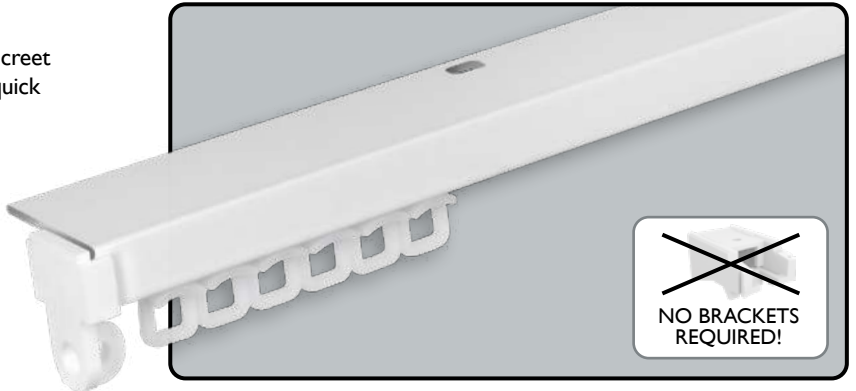

For Curtain Hooks see this Catalogue page 217

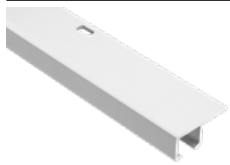

L-Section Aluminium Profile Track 6mm Channel
 Predrilled with holes
 Approx 200mm spacing between holes

Size: 6m (19'8") White Code: 16LS600W
 Packed: 10 Lengths Min Qty: 10

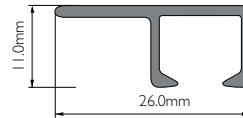

Colour finish available:
WHITE
RAL 9016

Profile Weight: 154g/m

Made-to-measure Kits include Track, Gliders and End Stops. It's an essential time saver for professional fitters – please see the table below for details.

L-Section Aluminium Profile Track Kit Components

NOTE: Kits are available up to the size ordered and can also be produced to your specific size.

Components	Track Kit Sizes							
	1.00m (3'3")	1.50m (4'11")	2.00m (6'7")	2.50m (8'2")	3.00m* (9'10")	4.00m* (13'1")	5.00m* (16'5")	6.00m* (19'8")
Profile Track	1 x 1.00m	1 x 1.50m	1 x 2.00m	1 x 2.50m	2 x 1.50m	2 x 2.00m	2 x 2.50m	2 x 3.00m
End Caps	2	2	2	2	2	2	2	2
Gliders^	10	16	20	26	30	40	50	60
Standard Glider Kit Code	16LSUS100W	16LSUS150W	16LSUS200W	16LSUS250W	16LSUS300W	16LSUS400W	16LSUS500W	16LSUS600W
Roller Glider Kit Code	16LSUR100W	16LSUR150W	16LSUR200W	16LSUR250W	16LSUR300W	16LSUR400W	16LSUR500W	16LSUR600W
60mm SurgeWave Kit Code	16LSU6100W	16LSU6150W	16LSU6200W	16LSU6250W	16LSU6300W	16LSU6400W	16LSU6500W	16LSU6600W
80mm SurgeWave Kit Code	16LSU8100W	16LSU8150W	16LSU8200W	16LSU8250W	16LSU8300W	16LSU8400W	16LSU8500W	16LSU8600W
Roller Surge 60 Kit Code	16LSURS6100W	16LSURS6150W	16LSURS6200W	16LSURS6250W	16LSURS6300W	16LSURS6400W	16LSURS6500W	16LSURS6600W
Roller Surge 80 Kit Code	16LSURS8100W	16LSURS8150W	16LSURS8200W	16LSURS8250W	16LSURS8300W	16LSURS8400W	16LSURS8500W	16LSURS8600W
Surge Ribbon 60 Kit Code	16LSURB6100W	16LSURB6150W	16LSURB6200W	16LSURB6250W	16LSURB6300W	16LSURB6400W	16LSURB6500W	16LSURB6600W
Surge Ribbon 80 Kit Code	16LSURB8100W	16LSURB8150W	16LSURB8200W	16LSURB8250W	16LSURB8300W	16LSURB8400W	16LSURB8500W	16LSURB8600W

Packed: 1 px / Outer 5 Min Qty: 1

NOTE: Kits come with 10 gliders per m unless otherwise specified.

*Track supplied in 2 pieces – unless specified

^For SurgeWave Kits the gliders are replaced with SurgeWave Gliders-on-a-string or SurgeWave Ribbon Gliders – see p176–177 to calculate the number of SurgeWave Gliders required.

	This curtain track is suitable for light-to-medium weight curtains		Suitable for straight runs ONLY		Kits/components are delivered in transport packaging		Available in contract components for large jobs		Available in kit form for simple ordering		Tracks available made-to-measure
--	--	--	---------------------------------	--	--	--	---	--	---	--	----------------------------------

DISCLAIMER: Whilst every effort has been made to ensure colour accuracy, due to the limitations of colour printing, please refer to product samples for colour matching. Product dimensions are for guidance only and may differ – please confirm details at time of ordering.

L-Section Aluminium Profile Track – Accessories

End Stops



L-Section End Cap with Eye
 White Code: 16LSECCW
 Packed: 10 Min Qty: 10



Large Metal Mid Stop for 6mm Channel
 Silver Code: 16HO044S
 Packed: 100 Min Qty: 100



Large Twist-Fit End Stop for 6mm Channel
 White Code: 16HO744W
 Packed: 100 Min Qty: 100



Large Metal Twist Stop for 6mm Channel
 Silver Code: 16HO997S
 Packed: 100 Min Qty: 100

Gliders & Accessories



Standard Gliders – strips of 10 6mm Channel
 White Code: 16HO738W
 Packed: 2000 Min Qty: 1000



Roller Gliders – Strips of 10 for 6mm Channel
 White Packed: 100 Code: 16HO025W
 White Packed: 1000 Code: 16HO025KW
 Min Qty: 100



Caraglidars – strips of 10 for 6mm Channel
 White Code: 16HO999W
 Packed: 1000 Min Qty: 1000



Heavy Duty Gliders for 6mm Channel
 White Code: 16HD307W
 Packed: 100 Min Qty: 10



Click-in Glider for 6mm Channel
 White Code: 16HO998W
 Packed: 1000 Min Qty: 1000



Standard Gliders with Large Metal S-Hook
 White Code: 16HO996W
 Packed: 100 Min Qty: 100



Standard Gliders with Small Metal S-Hook
 White Code: 16HO990W
 Packed: 100 Min Qty: 100

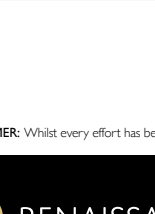

Caraglidars with Large Metal S-Hook
 White Code: 16HO994W
 Packed: 100 Min Qty: 100

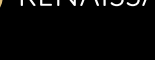

Caraglidars with Large Plastic S-Hook
 White Code: 16HO991W
 Packed: 100 Min Qty: 100

Overlap Arms



Overlap Arm for 6mm Channel
 Compatible with all gliders except for Heavy Duty
 Silver Code: 16WSOLI-
 Packed: 1 Min Qty: 1



Heavy Duty Underlap Arm Δ 6mm Channel
 White Code: 16HD301W
 Packed: 10 Min Qty: 10



Heavy Duty Overlap Arm Δ 6mm Channel
 White Code: 16HD303W
 Packed: 10 Min Qty: 10
 Δ Compatible when using Heavy Duty Gliders **ONLY**

SurgeWave® System Gliders & Accessories



SurgeWave® System Gliders-on-a-String for 6mm Channel
 White Spacing: 60mm Code: 16HH60GLST
 White Spacing: 80mm Code: 16HH80GLST
 Packed: 25m Min Qty: 25m

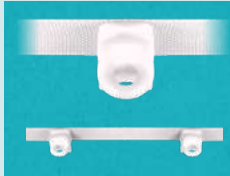

SurgeWave® System Ribbon Gliders for 6mm Channel
 White Spacing: 60mm Code: 16SW6RG60W
 White Spacing: 80mm Code: 16SW6RG80W
 Packed: 25m Min Qty: 25m



SurgeWave® Roller Gliders-on-a-String (Narrow) for 6mm Channel
 White Spacing: 60mm Code: 16GL6SR60W
 White Spacing: 80mm Code: 16GL6SR80W
 Packed: 30m Min Qty: 30m



SurgeWave® Click-In End Lock 6mm Channel
 Clear Code: 16SUESCW
 Packed: 100 Min Qty: 100



SurgeWave® System Curtain Tape
 With 60mm & 80mm Spacing Guides
 White Packed: 50m Code: 51TOWA3R
 White Packed: 100m Code: 51TOWA3CR
 Black Packed: 50m Code: 51TOWAK3R
 Min Qty: 100m



Iron-on SurgeWave® System Curtain Tape
 White Packed: 50m Code: 51TOWIA3R
 Min Qty: 100m

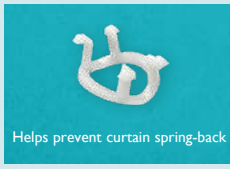

Friction Gliders for SurgeWave® System
NOTE: Not compatible with Ribbon Gliders
 White Packed: 1 Code: 16HSFG1W
 White Packed: 10 Code: 16HSFGDW
 White Packed: 100 Code: 16HSFGCW



Neat Pleat Guide for SurgeWave® System
 Clips onto 4mm & 6mm SurgeWave Gliders
 White Code: 16SURNP-
 Packed: 10 Min Qty: 10

For more details on how the SurgeWave® System works please see pages 165–180 in this Catalogue



Silent Glide

Our silent gliding track

Silent Glide is an economic alternative to similar styled specified semi-circular tracks, superb appearance and performance, Silent Glide is a heavy duty unobtrusive track designed for any curtain up to heavy weight curtains, and may be fixed by click or lever lock brackets for ceiling fix. When brand and performance is specified, use the Renaissance Brand.

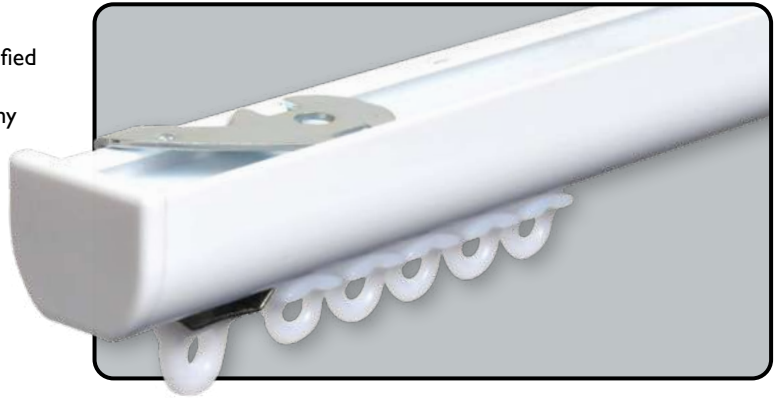

Silent Glide Aluminium Profile Track 6mm Channel

Size: 6m (19'8") White Code: 16SG600W
 Size: 6m (19'8") Silver Code: 16SG600W
 Size: 6m (19'8") Black Code: 16SG600W
 Packed: 20 Lengths Min Qty: 20

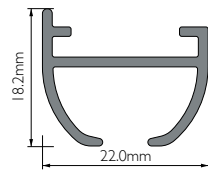

Colour finishes available:

WHITE RAL 9016	W
SILVER RAL 9006	T
BLACK RAL 9005	K

Insert your chosen colour letter reference at end of the Kit Code.

Profile Weight: 224g/m

Silent Glide Wall fix option
 To wall fix Silent Glide add an L-Extension Bracket to the Ceiling Lever Brackets
 3, 9 & 14cm L-Extension Bracket available + covers.
Note: L-Extension Brackets are sold separately and not supplied in Silent Glide Track Kits – please add in addition to Kit code

How it works:
 Easy fix Silent Glide Profile plastic Ceiling Click Brackets in action.

Fix

Unfix

Ceiling Lever Brackets are **hidden from show** thanks to the unique profile design.

Access to bracket easily from behind...
 ...but hidden from view from the front!

Components	Track Kit Sizes							
	1.00m (3'3")	1.50m (4'11")	2.00m (6'7")	2.50m (8'2")	3.00m* (9'10")	4.00m* (13'1")	5.00m* (16'5")	6.00m* (19'8")
Profile Track	1 x 1.00m	1 x 1.50m	1 x 2.00m	1 x 2.50m	2 x 1.50m	2 x 2.00m	2 x 2.50m	2 x 3.00m
Ceiling Brackets**	3	4	5	6	7	9	11	13
End Caps	2	2	2	2	2	2	2	2
Twist End Stops	2	2	2	2	2	2	2	2
Glidens^	10	16	20	26	30	40	50	60
Standard Glider Kit Code †	16SGUS100_	16SGUS150_	16SGUS200_	16SGUS250_	16SGUS300_	16SGUS400_	16SGUS500_	16SGUS600_
Roller Glider Kit Code †	16SGUR100_	16SGUR150_	16SGUR200_	16SGUR250_	16SGUR300_	16SGUR400_	16SGUR500_	16SGUR600_
60mm SurgeWave Kit Code †	16SGU6100_	16SGU6150_	16SGU6200_	16SGU6250_	16SGU6300_	16SGU6400_	16SGU6500_	16SGU6600_
80mm SurgeWave Kit Code †	16SGU8100_	16SGU8150_	16SGU8200_	16SGU8250_	16SGU8300_	16SGU8400_	16SGU8500_	16SGU8600_
Roller Surge 60 Kit Code †	16SGURS6100_	16SGURS6150_	16SGURS6200_	16SGURS6250_	16SGURS6300_	16SGURS6400_	16SGURS6500_	16SGURS6600_
Roller Surge 80 Kit Code †	16SGURS8100_	16SGURS8150_	16SGURS8200_	16SGURS8250_	16SGURS8300_	16SGURS8400_	16SGURS8500_	16SGURS8600_
Surge Ribbon 60 Kit Code †	16SGURB6100_	16SGURB6150_	16SGURB6200_	16SGURB6250_	16SGURB6300_	16SGURB6400_	16SGURB6500_	16SGURB6600_
Surge Ribbon 80 Kit Code †	16SGURB8100_	16SGURB8150_	16SGURB8200_	16SGURB8250_	16SGURB8300_	16SGURB8400_	16SGURB8500_	16SGURB8600_

Packed: 1 px / Outer 5 **Min Qty:** 1 † Insert your chosen colour letter reference at end of the Kit Code.
 * Denotes 2 piece profile with joiner. All kits include fittings. ** Ceiling Lever Brackets included as standard in all kits. For wall fix option please order L-Extension Brackets separately.
 ^ For SurgeWave Kits the gliders are replaced with SurgeWave Gliders-on-a-string or SurgeWave Ribbon Gliders – see p176-177 to calculate the number of SurgeWave Gliders required.

<p>This curtain track is suitable for medium-to-heavy weight curtains</p>	<p>Suitable for straight runs and can also be bent</p>	<p>Kits/components are delivered in transport packaging</p>	<p>Available in contract components for large jobs</p>	<p>Available in kit form for simple ordering</p>	<p>Tracks available made-to-measure</p>
---	--	---	--	--	---

DISCLAIMER: Whilst every effort has been made to ensure colour accuracy, due to the limitations of colour printing, please refer to product samples for colour matching. Product dimensions are for guidance only and may differ – please confirm details at time of ordering.

Silent Glide Aluminium Profile Track – Accessories

Brackets



Silent Glide Profile Plastic Ceiling Click Bracket

White Code: I6SGCCBW
Packed: 50 Min Qty: 10



Silent Glide Profile Ceiling Lever Bracket

Silver Code: I6SGCLBW
Packed: 50 Min Qty: 10



To wall fix just add an L-Extension Bracket to the Ceiling Lever Brackets

L-Extension Brackets can be used with tracks and blinds to increase the projection from the wall to the desired length. Covers are also available for a neat finish. See page 110.



3cm L-Extension Bracket

White Code: I6LB031W
Packed: 10 Min Qty: 10



9cm L-Extension Bracket

White Code: I6LB091W
 Silver Code: I6LB091S
 Black Code: I6LB091K
Packed: 10 Min Qty: 10

S 80mm

S 60mm



14cm L-Extension Bracket

White Code: I6LB141W
Packed: 10 Min Qty: 10

S 80mm

S 60mm

Screw for Double Track use Code: I6LSSCREW Packed: 10 Min Qty: 10



L-Extension Bracket Cover

A one-size-fits all solution for any size L-Extension Bracket – simply snap-off to fit to size.

White Code: I6LBCOVW
 Grey Code: I6LBCOVT
 Black Code: I6LBCOVK
Packed: 10 Min Qty: 10

End Cap & End Stops



Silent Glide Profile End Cap

White Code: I6SGECCW
 Grey Code: I6SGECCCT
 Black Code: I6SGECCCK
Packed: 100 Min Qty: 100



Large Metal Mid Stop for 6mm Channel

Silver Code: I6HO044S
Packed: 100 Min Qty: 100



Large Twist-Fit End Stop for 6mm Channel

White Code: I6HO744W
 Grey Code: I6HO744T
 Black Code: I6HO744K
Packed: 100 Min Qty: 100



Large Metal Twist Stop for 6mm Channel

Silver Code: I6HO997S
Packed: 100 Min Qty: 100

Joiner



Silent Glide Profile Joiner

White Code: I6SGJOIW
Packed: 50 Min Qty: 10



Gliders



Standard Gliders – Strips of 10 6mm Channel

White Code: I6HO738W
 Grey Code: I6HO738T
 Black Code: I6HO738K
Packed: 2000 Min Qty: 1000

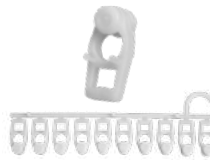

Roller Gliders – Strips of 10 for 6mm Channel

White Packed: 100 Code: I6HO025W
 White Packed: 1000 Code: I6HO025KW
Min Qty: 100

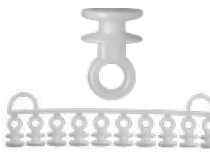

Caraglidars – Strips of 10 6mm Channel

White Code: I6HO999W
Packed: 1000 Min Qty: 1000



Heavy Duty Gliders for 6mm Channel

White Code: I6HD307W
Packed: 100 Min Qty: 10



Click-in Glider for 6mm Channel

White Code: I6HO998W
Packed: 1000 Min Qty: 1000

SurgeWave® System Gliders

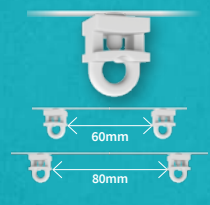

SurgeWave® System Gliders-on-a-String for 6mm Channel

White Spacing: 60mm Code: I6HH60GLST
 White Spacing: 80mm Code: I6HH80GLST
 Black Spacing: 60mm Code: I6HH60GLSK
 Black Spacing: 80mm Code: I6HH80GLSK
Packed: 25m Min Qty: 25m

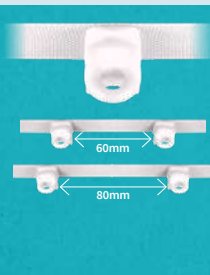

SurgeWave® System Ribbon Gliders for 6mm Channel

White Spacing: 60mm Code: I6SW6RG60W
 White Spacing: 80mm Code: I6SW6RG80W
 Grey Spacing: 60mm Code: I6SW6RG60G
 Grey Spacing: 80mm Code: I6SW6RG80G
 Black Spacing: 60mm Code: I6SW6RG60K
 Black Spacing: 80mm Code: I6SW6RG80K
Packed: 25m Min Qty: 25m



SurgeWave® Roller Gliders-on-a-String (Narrow) for 6mm Channel

White Spacing: 60mm Code: I6GL6SR60W
 White Spacing: 80mm Code: I6GL6SR80W
Packed: 30m Min Qty: 30m



SurgeWave® Click-In End Lock 6mm Channel

Clear Code: I6SUESCW
Packed: 100 Min Qty: 100

See overleaf for more Silent Glide SurgeWave® System Accessories

Silent Glide Aluminium Profile Track – Accessories

SurgeWave® System Accessories



SurgeWave® System Curtain Tape
With 60mm & 80mm Spacing Guides

<input type="checkbox"/> White	Packed: 50m	Code: 51TOWA3R
<input type="checkbox"/> White	Packed: 100m	Code: 51TOWA3CR
<input type="checkbox"/> Black	Packed: 50m	Code: 51TOWAK3R

Min Qty: 100m



Iron-on SurgeWave® System Curtain Tape

<input type="checkbox"/> White	Packed: 50m	Code: 51TOWIA3R
--------------------------------	-------------	-----------------

Min Qty: 100m



Friction Gliders for SurgeWave® System

NOTE: **Not** compatible with Ribbon Gliders

<input type="checkbox"/> White	Packed: 10	Code: 16HSFGDW
<input type="checkbox"/> White	Packed: 100	Code: 16HSFGCW
<input type="checkbox"/> Grey	Packed: 10	Code: 16HSFGDT
<input type="checkbox"/> Grey	Packed: 100	Code: 16HSFGCT
<input type="checkbox"/> Black	Packed: 10	Code: 16HSFGDK
<input type="checkbox"/> Black	Packed: 100	Code: 16HSFGCK

Helps prevent curtain spring-back



Neat Pleat Guide for SurgeWave® System
Clips onto 4mm & 6mm SurgeWave Gliders

<input type="checkbox"/> White	Code: 16SURNP-
Packed: 10	Min Qty: 10

For more details on how the SurgeWave® System works please see pages 165–180 in this Catalogue



Bending Service



Made-to-Measure Cutting Service
Code: 16MTMTRK

Silent Glide Track Bending Service:

Single Angle Bend

Code: 16SGBEND

Continuous Curve

Code: 16SGCONT

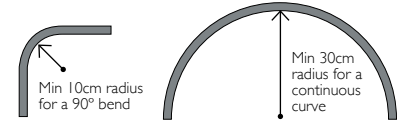

Please see page 227 for the Renaissance Metal Track Bending Form



10mm Track Spacers Ideal for projecting a bracket further from the wall or ceiling

<input type="checkbox"/> White	Code: 16HSSPCW
Packed: 100	Min Qty: 100

Silent Glide Wall fix option

To wall fix Silent Glide add an L-Extension Bracket to the Ceiling Lever Brackets

3, 9 & 14cm L-Extension Bracket available + covers.

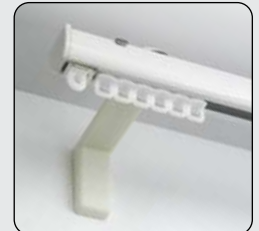

L-Extension Brackets are sold separately and not supplied in Track Kits – please add in addition Kit code

Add an L-Extension Bracket Cover for a neat finish

The one-size-fits all solution for any size L-Extension Bracket. Simply snaps-off to fit to size!

Available in 3 colour finishes to match your Silent Glide track colour choice.



Gliders with S-Hooks & Overlap Arms



Standard Gliders with Large Metal S-Hook

<input type="checkbox"/> White	Code: 16HO996W
Packed: 100	Min Qty: 100



Standard Gliders with Small Metal S-Hook

<input type="checkbox"/> White	Code: 16HO990W
Packed: 100	Min Qty: 100



Caraglidars with Large Metal S-Hook

<input type="checkbox"/> White	Code: 16HO994W
Packed: 100	Min Qty: 100



Caraglidars with Large Plastic S-Hook

<input type="checkbox"/> White	Code: 16HO991W
Packed: 100	Min Qty: 100



6mm Overlap Arm

Compatible with all gliders except for Heavy Duty

<input type="checkbox"/> Silver	Code: 16WSOLI-
Packed: 1	Min Qty: 1



Heavy Duty Underlap Arm ^Δ 6mm Channel

<input type="checkbox"/> White	Code: 16HD301W
Packed: 10	Min Qty: 10

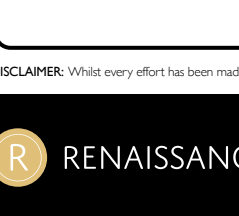

Heavy Duty Overlap Arm ^Δ 6mm Channel

<input type="checkbox"/> White	Code: 16HD303W
Packed: 10	Min Qty: 10

^Δ Compatible when using Heavy Duty Gliders **ONLY**

DISCLAIMER: Whilst every effort has been made to ensure colour accuracy, due to the limitations of colour printing, please refer to product samples for colour matching. Product dimensions are for guidance only and may differ – please confirm details at time of ordering.

Heavy Duty Corded Aluminium Profile Track

Corded heavy duty curtain track ideally suited for contracts and heavy curtains. Tracks can be joined for large spans.

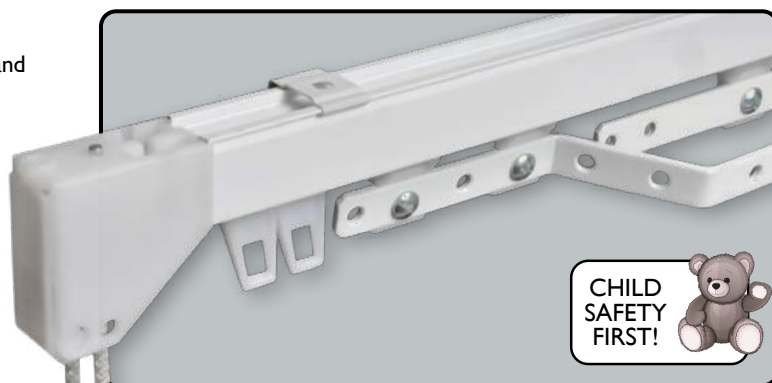

For Curtain Hooks see this Catalogue page 217

CHILD SAFETY FIRST! 



Heavy Duty Corded Aluminium Profile Track 6mm Channel

Size: 6m (19'8")
Packed: 5 Lengths

White
Min Qty: 5

Code: 16HD600W

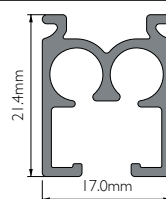

Colour finish available:
WHITE
RAL 9016

Profile Weight: 286g/m

Made-to-measure Kits include Track, Ceiling Brackets, Gliders, End Caps and End Stops. An essential time saver for fitters – see table below for details.

How it works: Wall fix option



Heavy Duty Corded Profile Top Fix Bracket + L-Extension Bracket – available in 3, 9 and 14cm sizes + covers

NOTE: L-Extension Brackets are sold separately and not supplied in Track Kits.

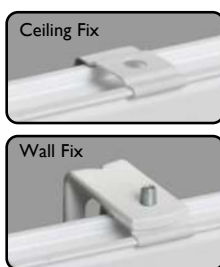

Also available
Spring Loaded Wall & Spring Loaded Ceiling Brackets (see overleaf)



Heavy Duty Corded Aluminium Profile Track Kit Components

NOTE: Kits are available up to the size ordered and can also be produced to your specific size.

Components	Track Kit Sizes							
	1.00m (3'3")	1.50m (4'11")	2.00m (6'7")	2.50m (8'2")	3.00m* (9'10")	4.00m* (13'1")	5.00m* (16'5")	6.00m* (19'8")
Profile Track	1 x 1.00m	1 x 1.50m	1 x 2.00m	1 x 2.50m	2 x 1.50m	2 x 2.00m	2 x 2.50m	2 x 3.00m
Ceiling Brackets†	3	4	5	6	7	9	11	13
End Caps	2	2	2	2	2	2	2	2
Twist End Stops	2	2	2	2	2	2	2	2
Heavy Duty Gliders^	10	16	20	26	30	40	50	60
Heavy Duty Glider Kit Code †	16HDCS100W	16HDCS150W	16HDCS200W	16HDCS250W	16HDCS300W	16HDCS400W	16HDCS500W	16HDCS600W
60mm SurgeWave Kit Code †	16HDC6100W	16HDC6150W	16HDC6200W	16HDC6250W	16HDC6300W	16HDC6400W	16HDC6500W	16HDC6600W
80mm SurgeWave Kit Code †	16HDC8100W	16HDC8150W	16HDC8200W	16HDC8250W	16HDC8300W	16HDC8400W	16HDC8500W	16HDC8600W
Roller Surge 60 Kit Code †	16HDCRS6100W	16HDCRS6150W	16HDCRS6200W	16HDCRS6250W	16HDCRS6300W	16HDCRS6400W	16HDCRS6500W	16HDCRS6600W
Roller Surge 80 Kit Code †	16HDCRS8100W	16HDCRS8150W	16HDCRS8200W	16HDCRS8250W	16HDCRS8300W	16HDCRS8400W	16HDCRS8500W	16HDCRS8600W

Packed: 1 px / Outer 5 Min Qty: 1

Please specify centre split or side stacked (RHS or LHS) when ordering MTM Corded. Please also specify RHS or LHS control.

* Denotes 2 piece profile with joiner. All kits include fittings. † For wall fix option please order L-Extension Brackets separately.

^ For SurgeWave Kits the gliders are replaced with SurgeWave Gliders-on-a-string – see p176-177 to calculate the number of SurgeWave Gliders required.

NOTE: Kits come with 10 gliders per m unless otherwise specified

 This curtain track is suitable for medium-to-heavy weight curtains	 Suitable for straight runs and can also be bent	 Kits/components are delivered in transport packaging	 Available in contract components for large jobs	 Available in kit form for simple ordering	 Tracks available made-to-measure
--	---	--	--	---	--

DISCLAIMER: Whilst every effort has been made to ensure colour accuracy, due to the limitations of colour printing, please refer to product samples for colour matching. Product dimensions are for guidance only and may differ – please confirm details at time of ordering.

Heavy Duty Corded Aluminium Profile Track – Accessories

Core Cording Components



Heavy Duty Corded Profile Cording Mechanism (Set – Left & Right)

White Code: 16HD305W
Packed: 10 Min Qty: 10



Heavy Duty Corded Profile Cord Connector/Conductor

White Code: 16HD306W
Packed: 10 Min Qty: 10



Heavy Duty Corded Cord 3.2mm

White Code: 16MOC32W
Packed: 500m Min Qty: 10m

Brackets



Heavy Duty Corded Profile Top Fix Bracket

Silver Code: 16HD304W
Packed: 10 Min Qty: 10



Spring-Loaded Ceiling Bracket

White Code: 16HDCSPIW
Packed: 10 Min Qty: 10



Spring-Loaded Wall Bracket

White Code: 16HDWSP1W
Packed: 10 Min Qty: 10

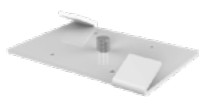

Suspended Ceiling Bracket

Used with tracks or blinds to fix to suspended ceilings.

White Code: 16HSSCCW
Packed: 100 Min Qty: 10

L-Extension Brackets can be used with tracks and blinds to increase the projection from the wall to the desired length. Covers are also available for a neat finish. See page 110.



3cm L-Extension Bracket

White Code: 16LB031W
Packed: 10 Min Qty: 10



9cm L-Extension Bracket

White Code: 16LB091W
Packed: 10 Min Qty: 10



14cm L-Extension Bracket

White Code: 16LB141W
Packed: 10 Min Qty: 10



Screw for Double Track use Code: 16LSSCREW Packed: 10 Min Qty: 10



L-Extension Bracket Cover

A one-size-fits all solution for any size L-Extension Bracket – simply snap-off to fit to size.

White Code: 16LBCOVW
Packed: 10 Min Qty: 10

Track Joiner



Heavy Duty Corded Profile Joiner

White Code: 16HD310W
Packed: 10 Min Qty: 10

End Stops



Large Metal Mid Stop for 6mm Channel

Silver Code: 16HO044S
Packed: 100 Min Qty: 100



Large Twist-Fit End Stop for 6mm Channel

White Code: 16HO744W
Packed: 100 Min Qty: 100



Large Metal Twist Stop for 6mm Channel

Silver Code: 16HO997S
Packed: 100 Min Qty: 100

Gliders & Glider Accessories



Standard Gliders – Strips of 10 6mm Channel

White Code: 16HO738W
Packed: 2000 Min Qty: 1000



Roller Gliders – Strips of 10 for 6mm Channel

White Packed: 100 Code: 16HO025W
 White Packed: 1000 Code: 16HO025KW
Min Qty: 100

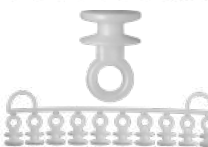

Caragliders – Strips of 10 6mm Channel

White Code: 16HO999W
Packed: 1000 Min Qty: 1000



Heavy Duty Gliders for 6mm Channel

White Code: 16HD307W
Packed: 100 Min Qty: 10



Click-in Glider for 6mm Channel

White Code: 16HO998W
Packed: 1000 Min Qty: 1000



Standard Gliders with Large Metal S-Hook

White Code: 16HO996W
Packed: 100 Min Qty: 100



Standard Gliders with Small Metal S-Hook

White Code: 16HO990W
Packed: 100 Min Qty: 100



Caragliders with Large Metal S-Hook

White Code: 16HO994W
Packed: 100 Min Qty: 100

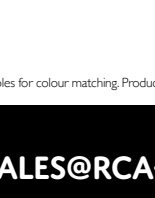

Caragliders with Large Plastic S-Hook

White Code: 16HO991W
Packed: 100 Min Qty: 100

These Glider Attachments can be added to gliders with an 'eye' to connect to curtains

Plastic S-Hook Code: 16HO995W

Packed: 1000 Min Qty: 1000

Large Metal S-Hook 39mm Code: 16HO072S

Small Metal S-Hook 29mm Code: 16HO071S

Packed: 100 Min Qty: 100

DISCLAIMER: Whilst every effort has been made to ensure colour accuracy, due to the limitations of colour printing, please refer to product samples for colour matching. Product dimensions are for guidance only and may differ – please confirm details at time of ordering.

Heavy Duty Corded Aluminium Profile Track – Accessories

Overlap Arms



Corded 6mm Track Overlap Arm with Swivel Gliders
Specially designed for smooth running on curves
Code: 16MCOLAR
Packed: 10 Min Qty: 10



Heavy Duty Underlap Arm ^Δ 6mm Channel
 White Code: 16HD301W
Packed: 10 Min Qty: 10



Heavy Duty Overlap Arm ^Δ 6mm Channel
 White Code: 16HD303W
Packed: 10 Min Qty: 10
^Δ Compatible when using Heavy Duty Gliders **ONLY**

SurgeWave® System Gliders & Accessories



SurgeWave® System Gliders-on-a-String for 6mm Channel
 White Spacing: 60mm Code: 16HH60GLST
 White Spacing: 80mm Code: 16HH80GLST
Packed: 25m Min Qty: 25m



SurgeWave® System Ribbon Gliders for 6mm Channel
 White Spacing: 60mm Code: 16SW6RG60W
 White Spacing: 80mm Code: 16SW6RG80W
Packed: 25m Min Qty: 25m



SurgeWave® Roller Gliders-on-a-String (Narrow) for 6mm Channel
 White Spacing: 60mm Code: 16GL6SR60W
 White Spacing: 80mm Code: 16GL6SR80W
Packed: 30m Min Qty: 30m



SurgeWave® Click-In End Lock 6mm Channel
 Clear Code: 16SUESCW
Packed: 100 Min Qty: 100



SurgeWave® System Curtain Tape
With 60mm & 80mm Spacing Guides
 White Packed: 50m Code: 51TOWA3R
 White Packed: 100m Code: 51TOWA3CR
 Black Packed: 50m Code: 51TOWAK3R
Min Qty: 100m



Iron-on SurgeWave® System Curtain Tape
 White Packed: 50m Code: 51TOWIA3R
Min Qty: 100m



Friction Gliders for SurgeWave® System
 White Packed: 1 Code: 16HSFG1W
 White Packed: 10 Code: 16HSFGDW
 White Packed: 100 Code: 16HSFGCW

Helps prevent curtain spring-back

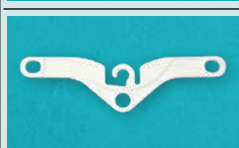

Neat Pleat Guide for SurgeWave® System
Clips onto 4mm & 6mm SurgeWave Gliders
 White Code: 16SURNP-
Packed: 10 Min Qty: 10

For more details on how the SurgeWave® System works please see pages 165–180 in this Catalogue



Bending



Table Mounted Bending Tool for Heavy Duty Corded Profile
(includes 1 set of bending inserts)
Code: 16HDLBEN Packed: 1

Internal and external bends can be formed



Spare Bending Insert Sets (2-piece)
Insert into the glider and bracket channel of aluminium track to prevent damage to the channel whilst bending
Code: 16HDINST Packed: 1 Min Qty: 1



Made-to-Measure Cutting Service
Code: 16MTMTRK

Heavy Duty Corded Track Bending Service:
Single Angle Bend Code: 16HDBEND
Continuous Curve Code: 16HDCONT



Please see page 227 for the Renaissance Metal Track Bending Form

Corded Track Child Safety Accessories



Safety Boxes
To be mounted to the wall for use with continuous chain and/or cord operations. For use with vertical and dual control blinds
Single Safety Box Code: 58WASBSG
Double Safety Box Code: 58WASBDB
Packed: 100 Min Qty: 10



Safety Warning Tag with string
Code: 58WASTST
Packed: 100 Min Qty: 10



Clear Safety Cord Guide
Code: 58WASCCL
Packed: 100 Min Qty: 100



Cord Tensioners
 White
Plastic Tensioner Code: 18CTCTPW
Metal Tensioner Code: 18CTCTMW
Packed: 1 px/Outer 10



10mm Track Spacers Ideal for projecting a bracket further from the wall or ceiling
 White Code: 16HSSPCW
Packed: 100 Min Qty: 100

DISCLAIMER: Whilst every effort has been made to ensure colour accuracy, due to the limitations of colour printing, please refer to product samples for colour matching. Product dimensions are for guidance only and may differ – please confirm details at time of ordering.

Heavy Duty H-Section Aluminium Profile Track

Large traditional Heavy Duty H-Section Aluminium Profile Track for heavy domestic and contract curtain installations.

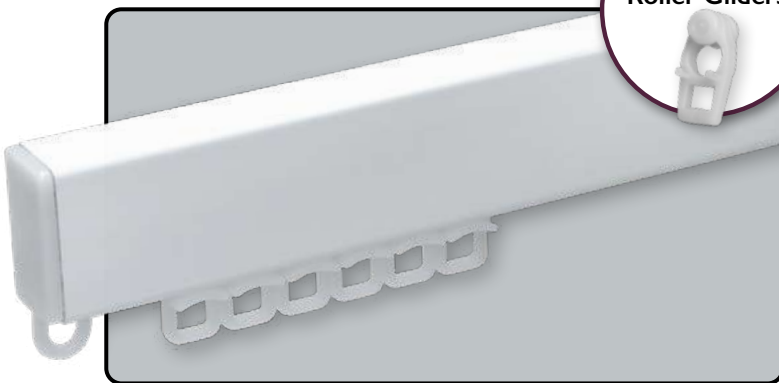

For Curtain Hooks see this Catalogue page 217

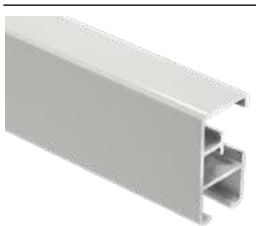

Profile Weight: 224g/m

Heavy Duty H-Section Aluminium Profile Track 6mm Channel

- Size: 6m (19'8") White Code: I6HH600W
- Size: 6m (19'8") Silver Code: I6HH600T
- Size: 6m (19'8") Black Code: I6HH600K
- Packed: 10 Lengths Min Qty: 10

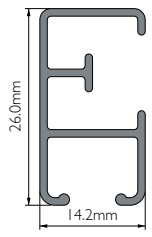

Colour finishes available:

WHITE RAL 9016	W
SILVER RAL 9006	T
BLACK RAL 9005	K

Insert your chosen colour letter reference at end of the Kit Code.

Made-to-measure Kits include Track, Brackets, Gliders and End Caps with eyes. An essential time saver for professional fitters – see table below for details.

Components	Track Kit Sizes							
	1.00m (3'3")	1.50m (4'11")	2.00m (6'7")	2.50m (8'2")	3.00m* (9'10")	4.00m* (13'1")	5.00m* (16'5")	6.00m* (19'8")
Profile Track	1 x 1.00m	1 x 1.50m	1 x 2.00m	1 x 2.50m	2 x 1.50m	2 x 2.00m	2 x 2.50m	2 x 3.00m
Brackets**	3	4	5	6	7	9	11	13
End Cap with Eye	2	2	2	2	2	2	2	2
Gliders^	10	16	20	26	30	40	50	60
Standard Glider Kit Code †	16HHUS100_	16HHUS150_	16HHUS200_	16HHUS250_	16HHUS300_	16HHUS400_	16HHUS500_	16HHUS600_
Roller Glider Kit Code †	16HHUR100_	16HHUR150_	16HHUR200_	16HHUR250_	16HHUR300_	16HHUR400_	16HHUR500_	16HHUR600_
60mm SurgeWave Kit Code †	16HHU6100_	16HHU6150_	16HHU6200_	16HHU6250_	16HHU6300_	16HHU6400_	16HHU6500_	16HHU6600_
80mm SurgeWave Kit Code †	16HHU8100_	16HHU8150_	16HHU8200_	16HHU8250_	16HHU8300_	16HHU8400_	16HHU8500_	16HHU8600_
Roller Surge 60 Kit Code †	16HHURS6100_	16HHURS6150_	16HHURS6200_	16HHURS6250_	16HHURS6300_	16HHURS6400_	16HHURS6500_	16HHURS6600_
Roller Surge 80 Kit Code †	16HHURS8100_	16HHURS8150_	16HHURS8200_	16HHURS8250_	16HHURS8300_	16HHURS8400_	16HHURS8500_	16HHURS8600_
Surge Ribbon 60 Kit Code †	16HHURB6100_	16HHURB6150_	16HHURB6200_	16HHURB6250_	16HHURB6300_	16HHURB6400_	16HHURB6500_	16HHURB6600_
Surge Ribbon 80 Kit Code †	16HHURB8100_	16HHURB8150_	16HHURB8200_	16HHURB8250_	16HHURB8300_	16HHURB8400_	16HHURB8500_	16HHURB8600_

Packed: 1 px / Outer 5 **Min Qty:** 1 † Insert your chosen colour letter reference at end of the Kit Code.

NOTE: Kits come with 10 gliders per m unless otherwise specified.

* Denotes 2 piece profile with joiner. All kits include fittings.
 ** Standard Glider Kits = 4cm Leverlock Wall/Ceiling Brackets • 60mm SurgeWave Kits = 6cm Wall/Ceiling Leverlock Brackets • 80mm SurgeWave Kits = 8cm Leverlock Brackets
 ^ For SurgeWave Kits the gliders are replaced with SurgeWave Gliders-on-a-string or SurgeWave Ribbon Gliders – see **p176-177** to calculate the number of SurgeWave Gliders required.

<p>KG MEDIUM HEAVY</p>	<p>This curtain track is suitable for medium-to-heavy weight curtains</p>	<p>Suitable for straight runs and can also be bent</p>	<p>Kits/components are delivered in transport packaging</p>	<p>Available in contract components for large jobs</p>	<p>Available in kit form for simple ordering</p>	<p>Tracks available made-to-measure</p>
---------------------------------------	---	--	---	--	--	---

DISCLAIMER: Whilst every effort has been made to ensure colour accuracy, due to the limitations of colour printing, please refer to product samples for colour matching. Product dimensions are for guidance only and may differ – please confirm details at time of ordering.

Heavy Duty H-Section Aluminium Profile Track – Accessories

Brackets



Ceiling Standard Bracket (with Slot)

White Code: 16HSBCCW
Packed: 100 Min Qty: 100

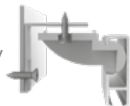

Ceiling Standard Bracket (with Hole)

White Code: 16HSBHCW
 Black Code: 16HSBHCK
Packed: 100 Min Qty: 100



4cm Standard Wall/Ceiling Bracket

White Code: 16HSB4CW
Packed: 100 Min Qty: 100

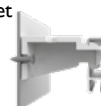

6cm Standard Wall/Ceiling Bracket

White Code: 16HSB6CW
Packed: 100 Min Qty: 100



4cm Leverlock Wall/Ceiling Bracket

White Code: 16HSL4CW
 Grey Code: 16HSL4CT
 Black Code: 16HSL4CK
Packed: 100 Min Qty: 100



5cm Leverlock Wall/Ceiling Bracket

White Code: 16HSL5CW
 Grey Code: 16HSL5CT
 Black Code: 16HSL5CK
Packed: 100 Min Qty: 100



6cm Leverlock Wall/Ceiling Bracket

White Code: 16HSL6CW
 Grey Code: 16HSL6CT
 Black Code: 16HSL6CK
Packed: 100 Min Qty: 100

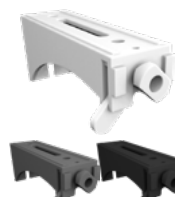

8cm Leverlock Wall/Ceiling Bracket

White Code: 16HSL8CW
 Grey Code: 16HSL8CT
 Black Code: 16HSL8CK
Packed: 100 Min Qty: 100



Ceiling Leverlock Bracket (with Hole)

White Code: 16HSLCCW
 Grey Code: 16HSLCCT
 Black Code: 16HSLCCK
Packed: 100 Min Qty: 100



Flush Wall Fix Bracket

White Code: 16HSFBCW
Packed: 100 Min Qty: 100

L-Extension Brackets & Covers

L-Extension Brackets can be used with tracks and blinds to increase the projection from the wall to the desired length. Covers are also available for a neat finish. See page 110.



3cm L-Extension Bracket

White Code: 16LB031W
Packed: 10 Min Qty: 10



9cm L-Extension Bracket

White Code: 16LB091W
 Silver Code: 16LB091S
 Black Code: 16LB091K
Packed: 10 Min Qty: 10



14cm L-Extension Bracket

White Code: 16LB141W
Packed: 10 Min Qty: 10



Screw for Double Track use Code: 16LSSCREW Packed: 10 Min Qty: 10



L-Extension Bracket Cover

A one-size-fits all solution for any size L-Extension Bracket – simply snap-off to fit to size.

White Code: 16LBCOVW
 Grey Code: 16LBCOVT
 Black Code: 16LBCOVK
Packed: 10 Min Qty: 10

End Cap & End Stops



Heavy Duty H-Section End Cap with Eye

White Code: 16HHECCW
 Grey Code: 16HHECCT
 Black Code: 16HHECCK
Packed: 100 Min Qty: 100



Large Metal Mid Stop for 6mm Channel

Silver Code: 16HO044S
Packed: 100 Min Qty: 100



SurgeWave Click-In End Lock 6mm Channel

Clear Code: 16SUESCW
Packed: 100 Min Qty: 100



Large Twist-Fit End Stop for 6mm Channel

White Code: 16HO744W
 Grey Code: 16HO744T
 Black Code: 16HO744K
Packed: 100 Min Qty: 100



Large Metal Twist Stop for 6mm Channel

Silver Code: 16HO997S
Packed: 100 Min Qty: 100

Track Joiner



H-Section Profile Joiner

Works with Optimal, Principal (White ONLY), Professional & Heavy Duty H-Section Tracks

Code: 16HSJODW

Packed: 10 Min Qty: 10

DISCLAIMER: Whilst every effort has been made to ensure colour accuracy, due to the limitations of colour printing, please refer to product samples for colour matching. Product dimensions are for guidance only and may differ – please confirm details at time of ordering.

Heavy Duty H-Section Aluminium Profile Track – Accessories

Gliders & Overlap Arms



Standard Gliders – Strips of 10 6mm Channel

- White Code: 16HO738W
 - Grey Code: 16HO738T
 - Black Code: 16HO738K
- Packed: 2000 Min Qty: 1000



Roller Gliders – Strips of 10 for 6mm Channel

- White Packed: 100 Code: 16HO025W
 - White Packed: 1000 Code: 16HO025KW
- Min Qty: 100

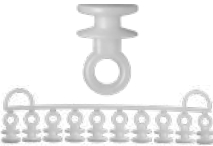

Caraglidars – Strips of 10 6mm Channel

- White Code: 16HO999W
- Packed: 1000 Min Qty: 1000



Heavy Duty Gliders for 6mm Channel

- White Code: 16HD307W
- Packed: 100 Min Qty: 10



Click-in Glider for 6mm Channel

- White Code: 16HO998W
- Packed: 1000 Min Qty: 1000



Standard Gliders with Large Metal S-Hook

- White Code: 16HO996W
- Packed: 100 Min Qty: 100

Standard Gliders with Small Metal S-Hook

- White Code: 16HO990W
- Packed: 100 Min Qty: 100



Caraglidars with Large Metal S-Hook

- White Code: 16HO994W
- Packed: 100 Min Qty: 100

Caraglidars with Large Plastic S-Hook

- White Code: 16HO991W
- Packed: 100 Min Qty: 100

These Glider Attachments can be added to gliders with an 'eye' to connect to curtains



- Plastic S-Hook Code: 16HO995W
- Packed: 1000 Min Qty: 1000

Large Metal S-Hook 39mm Code: 16HO072S

Small Metal S-Hook 29mm Code: 16HO071S

- Packed: 100 Min Qty: 100



6mm Overlap Arm

Compatible with all gliders except for Heavy Duty

- Silver Code: 16WSOLI-
- Packed: 1 Min Qty: 1



Heavy Duty Underlap Arm ^Δ 6mm Channel

- White Code: 16HD301W
- Packed: 10 Min Qty: 10



Heavy Duty Overlap Arm ^Δ 6mm Channel

- White Code: 16HD303W
- Packed: 10 Min Qty: 10

^Δ Compatible when using Heavy Duty Gliders **ONLY**

SurgeWave® System Gliders & Accessories

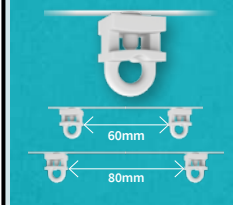

SurgeWave® System Gliders-on-a-String for 6mm Channel

- White Spacing: 60mm Code: 16HH60GLST
 - White Spacing: 80mm Code: 16HH80GLST
 - Black Spacing: 60mm Code: 16HH60GLSK
 - Black Spacing: 80mm Code: 16HH80GLSK
- Packed: 25m Min Qty: 25m

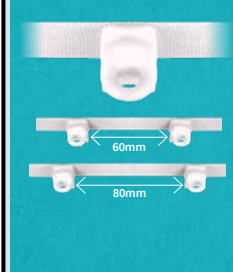

SurgeWave® System Ribbon Gliders for 6mm Channel

- White Spacing: 60mm Code: 16SW6RG60W
 - White Spacing: 80mm Code: 16SW6RG80W
 - Grey Spacing: 60mm Code: 16SW6RG60G
 - Grey Spacing: 80mm Code: 16SW6RG80G
 - Black Spacing: 60mm Code: 16SW6RG60K
 - Black Spacing: 80mm Code: 16SW6RG80K
- Packed: 25m Min Qty: 25m



SurgeWave® Roller Gliders-on-a-String (Narrow) for 6mm Channel

- White Spacing: 60mm Code: 16GL6SR60W
 - White Spacing: 80mm Code: 16GL6SR80W
- Packed: 30m Min Qty: 30m



SurgeWave® Click-In End Lock 6mm Channel

- Clear Code: 16SUESCW
- Packed: 100 Min Qty: 100



SurgeWave® System Curtain Tape With 60mm & 80mm Spacing Guides

- White Packed: 50m Code: 51TOWA3R
 - White Packed: 100m Code: 51TOWA3CR
 - Black Packed: 50m Code: 51TOWAK3R
- Min Qty: 100m



Iron-on SurgeWave® System Curtain Tape

- White Packed: 50m Code: 51TOWIA3R
- Min Qty: 100m



Friction Gliders for SurgeWave® System

NOTE: Not compatible with Ribbon Gliders

- White Packed: 10 Code: 16HSFGDW
- White Packed: 100 Code: 16HSFGCW
- Grey Packed: 10 Code: 16HSFGDT
- Grey Packed: 100 Code: 16HSFGCT
- Black Packed: 10 Code: 16HSFGDK
- Black Packed: 100 Code: 16HSFGCK



Neat Pleat Guide for SurgeWave® System Clips onto 4mm & 6mm SurgeWave Gliders

- White Code: 16SURNP-
- Packed: 10 Min Qty: 10

For more details on how the SurgeWave® System works please see pages 165–180 in this Catalogue



10mm Track Spacers Ideal for projecting a bracket further from the wall or ceiling

- White Code: 16HSSPCW
- Packed: 100 Min Qty: 100

Heavy Duty H-Section Aluminium Profile Track – Accessories

Bending



Large Portable Bending Tool for Optimal H-Section, Principal H-Section, Professional Large Curved Profile, W-Section Profile, Heavy Duty H-Section Profile and Cubicle Rail (includes 1 set of bending inserts)

Code: I6MPLBEN

Packed: 1 Min Qty: 1

Internal and external bends can be formed

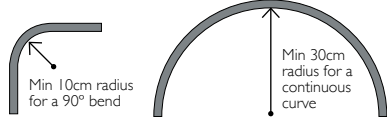

Spare Bending Insert Sets (2-piece)

Code: I6HHINST

Packed: 1 Min Qty: 1



Made-to-Measure Cutting Service

Code: I6MTMTRK

Heavy Duty H-Section Track Bending Service:
Single Angle Bend Code: I6HHBEND
Continuous Curve Code: I6HHCONT



Please see page 227 for the Renaissance Metal Track Bending Form

SurgeWave® Ribbon Gliders

Our neatest 6mm SurgeWave® gliders yet!

Available in 60mm & 80mm spacing and in 3 colours:
White • Black • Grey

For full details see page 174



COMPATIBLE PRODUCT

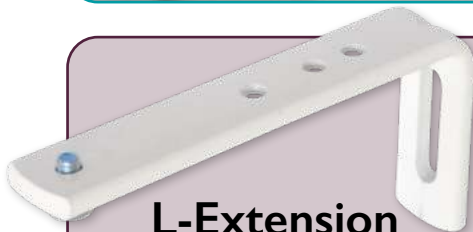

L-Extension Brackets

To help stop blinds/curtains catching on protruding radiators or door handles. Also ideal for wall mounted SurgeWave Tracks to ensure there is enough clearance space for the deep pleats SurgeWave creates.

Available in various Sizes & Colours



Double Track Solution

Additional L-Extension Screw also available to allow for Double Track usage too!



ONE SIZE FITS ALL SOLUTION

Available in 3 colours

L-Extension Bracket Covers

For a super-neat finish the one size cover is compatible with all sizes of L-Extension Brackets

This design will work on all sizes of L-Extension bracket. Simply bend the bracket cover at the designated break marker and it will snap-off to your required size. Simple!

For Double Track the bracket cover can only be used up to the first track

DISCLAIMER: Whilst every effort has been made to ensure colour accuracy, due to the limitations of colour printing, please refer to product samples for colour matching. Product dimensions are for guidance only and may differ – please confirm details at time of ordering.

Cubicle Rail

Aluminium Track

Contract heavy duty aluminium curtain rail for use on large spans, straight or bent lengths, with additional ceiling support for high ceilings, with or without wall fixing, for creating adjoining cubicles/dividers. Ideal for use in hospitals, clinics, surgeries, hotels, offices, changing rooms, shower cubicles etc. Open channel at the top of the rail means it can be fixed without drilling, while the top cover keeps the rail clean and protected. All items available in Strong Powder Coated White or Silver Anodised finish.

An optional PVC Top Cover is also available for easy cleaning and improved hygiene.

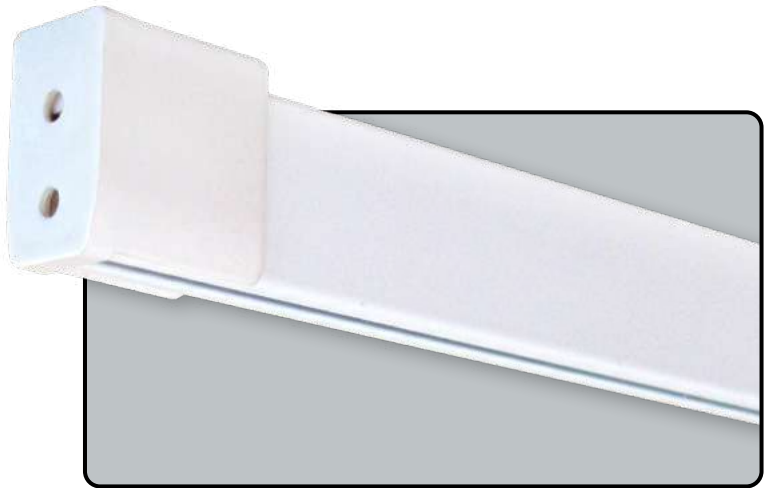

Cubicle Rail 6mm Channel

Size: 6m (19'8")

Size: 6m (19'8")

Packed: 10 Lengths

 Silver Anodised Code: 16HO600S

 White Code: 16HO600W

Min Qty: 10

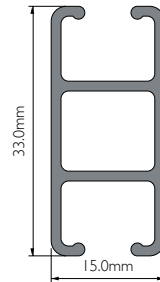

Colour finishes available:

WHITE
RAL 9016

SILVER ANODISED

Profile Weight: 359g/m

Various accessories available:



Cubicle Rail is not available in Kits please order by component form. Call us to discuss your own bespoke layout requirements.



This curtain track is suitable for medium-to-heavy weight curtains



Suitable for straight runs and can also be bent



Kits/components are delivered in transport packaging



Available in contract components for large jobs



Ceiling Suspension solutions available



Tracks available made-to-measure

DISCLAIMER: Whilst every effort has been made to ensure colour accuracy, due to the limitations of colour printing, please refer to product samples for colour matching. Product dimensions are for guidance only and may differ – please confirm details at time of ordering.

Cubicle Rail Aluminium Track – Accessories

Brackets



Cubicle Rail Adjustable Metal Bracket for angled ceilings

Silver Anodised Code: 16HO143S
 White Code: 16HO143W
 Packed: 10 Min Qty: 10



Cubicle Rail Fixed Metal Side/Wall Bracket

Silver Anodised Code: 16HO140S
 White Code: 16HO140W
 Packed: 10 Min Qty: 10



Cubicle Rail Adjustable Metal Bracket for angled walls

Silver Anodised Code: 16HO142S
 White Code: 16HO142W
 Packed: 10 Min Qty: 10



6cm L-Wall Bracket

Silver Code: 16HO006S
 White Code: 16HO006W
 Packed: 25 Min Qty: 10



10cm L-Wall Bracket

Silver Code: 16HO110S
 White Code: 16HO110W
 Packed: 25 Min Qty: 10



14cm L-Wall Bracket

Silver Code: 16HO114S
 White Code: 16HO114W
 Packed: 20 Min Qty: 10



T-Join Connecting Piece/Ceiling Fix Bracket

Silver Code: 16HO015S
 White Code: 16HO015W
 Packed: 100 Min Qty: 10

Remove 2 screws for ceiling fix



Cubicle Rail Wide L-Wall Bracket

White Code: 16HOBLCW
 Silver Anodised Code: 16HOB LCS
 Packed: 100 Min Qty: 10
 Can be turned through 90° if longer machine screws are used.



Cubicle Rail Wide T-Wall Bracket

White Code: 16HOBTCW
 Silver Anodised Code: 16HOB TCS
 Packed: 100 Min Qty: 10



10mm Track Spacers Ideal for projecting a bracket further from the wall or ceiling

White Code: 16HSSPCW
 Packed: 100 Min Qty: 100



Abrasive Aluminium Track Cleaner

Ideal for removing small scratches and blemishes. For use on Silver Anodised tracks only.
 Code: 16ALABRA Packed: 1 Min Qty: 1

Brackets

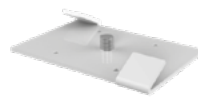

Suspended Ceiling Bracket

Used with tracks or blinds to fix to suspended ceilings.

White Code: 16HSSCCW
 Packed: 100 Min Qty: 10



T-Join Connecting Piece/Ceiling Fix Bracket

Silver Anodised Code: 16HO015S
 White Code: 16HO015W

Remove 2 screws for ceiling fix

Packed: 100 Min Qty: 10



16mm Tube for Ceiling Support – 5m (16'5") length

Silver Anodised Code: 16HOF43S
 White Code: 16HOF43W
 Packed: 10 Lengths Min Qty: 10



16mm Tube/Rail connector for Ceiling Support

Silver Anodised Code: 16HOF45S
 White Code: 16HOF45W
 Packed: 10 Min Qty: 10

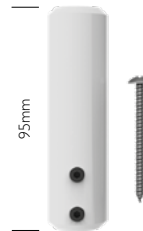

16mm Ceiling/Tube connector for Ceiling Support

Silver Anodised Code: 16HOF42S
 White Code: 16HOF42W
 Packed: 10 Min Qty: 10



16mm Connector Direct Track/Ceiling

Silver Anodised Code: 16HO939S
 White Code: 16HO939W
 Packed: 10 Min Qty: 10



16mm Tube complete Ceiling Support

Size: 100cm Silver Anodised Code: 16HOC10S
 Size: 100cm White Code: 16HOC10W
 Size: 125cm Silver Anodised Code: 16HOC13S
 Size: 125cm White Code: 16HOC13W
 Size: 150cm Silver Anodised Code: 16HOC15S
 Size: 150cm White Code: 16HOC15W
 Size: 175cm Silver Anodised Code: 16HOC18S
 Size: 175cm White Code: 16HOC18W
 Size: 200cm Silver Anodised Code: 16HOC20S
 Size: 200cm White Code: 16HOC20W
 Packed: 10 Min Qty: 10



V-Hanger Complete

Drop: 80cm Silver Anodised Code: 16HOV08S
 Drop: 80cm White Code: 16HOV08W
 Drop: 100cm Silver Anodised Code: 16HOV10S
 Drop: 100cm White Code: 16HOV10W
 Drop: 150cm Silver Anodised Code: 16HOV15S
 Drop: 150cm White Code: 16HOV15W
 Packed: 1 Min Qty: 1

DISCLAIMER: Whilst every effort has been made to ensure colour accuracy, due to the limitations of colour printing, please refer to product samples for colour matching. Product dimensions are for guidance only and may differ – please confirm details at time of ordering.

Cubicle Rail Aluminium Track – Accessories

Joiners and Covers



Cubicle Rail 30cm Bridge for joining on bends
 Silver Code: 16HO014S
 White Code: 16HO014W
 Packed: 1 Min Qty: 1



Cubicle Rail Joiner
 Silver Code: 16HO002S
 Packed: 25 Min Qty: 10



T-Join Connecting Piece/Ceiling Fix Bracket
 White Code: 16HO015W
 Silver Code: 16HO015S
 Remove 2 screws for ceiling fix Packed: 100 Min Qty: 10

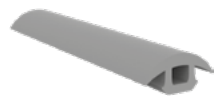

PVC Profile Top Cover
 Grey Code: 16HO016T
 White Code: 16HO016W
 Packed: 50m Approx Min Qty: 10m

End Stops and End Caps



Plastic End Stopper with Screw Eye
 White Code: 16HO743W
 Packed: 100 Min Qty: 100



Large Metal Mid Stop for 6mm Channel
 Silver Code: 16HO044S
 Packed: 100 Min Qty: 100



SurgeWave Click-In End Stop for 6mm Channel
 Clear Code: 16SUESCW
 Packed: 100 Min Qty: 100



Large Twist-Fit End Stop for 6mm Channel
 White Code: 16HO744W
 Grey Code: 16HO744T
 Packed: 100 Min Qty: 100



Large Metal Twist Stop for 6mm Channel
 Silver Code: 16HO997S
 Packed: 100 Min Qty: 100



Cubicle Rail Side Bracket/End Cap Fixed Eye
 Grey Code: 16HO018T
 White Code: 16HO018W
 Packed: 100 Min Qty: 10



Cubicle Rail End Cap (without holes)
 Sealed to prevent infection getting access to track
 Grey Code: 16HO040T
 White Code: 16HO040W
 Packed: 40 Min Qty: 10



Cubicle Rail Side Bracket/End Cap (with holes)
 For wall fix
 Grey Code: 16HO017T
 White Code: 16HO017W
 Packed: 40 Min Qty: 10

Gliders & Overlap Arms



Standard Gliders – Strips of 10 6mm Channel
 White Code: 16HO738W
 Grey Code: 16HO738T
 Packed: 2000 Min Qty: 1000



Roller Gliders – Strips of 10 for 6mm Channel
 White Packed: 100 Code: 16HO025W
 White Packed: 1000 Code: 16HO025KW
 Min Qty: 100

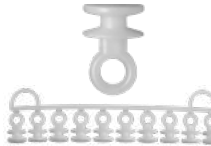

Caraglidars – Strips of 10 6mm Channel
 White Code: 16HO999W
 Packed: 1000 Min Qty: 1000



Heavy Duty Gliders for 6mm Channel
 White Code: 16HD307W
 Packed: 100 Min Qty: 10



Click-in Glider for 6mm Channel
 White Code: 16HO998W
 Packed: 1000 Min Qty: 1000



Standard Gliders with Large Metal S-Hook
 White Code: 16HO996W
 Packed: 100 Min Qty: 100



Standard Gliders with Small Metal S-Hook
 White Code: 16HO990W
 Packed: 100 Min Qty: 100



Caraglidars with Large Metal S-Hook
 White Code: 16HO994W
 Packed: 100 Min Qty: 100



Caraglidars with Large Plastic S-Hook
 White Code: 16HO991W
 Packed: 100 Min Qty: 100

These Glider Attachments can be added to gliders with an 'eye' to connect to curtains



Plastic S-Hook Code: 16HO995W
 Packed: 1000 Min Qty: 1000



Large Metal S-Hook 39mm Code: 16HO072S
Small Metal S-Hook 29mm Code: 16HO071S
 Packed: 100 Min Qty: 100

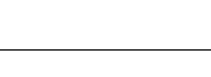

6mm Overlap Arm
 Compatible with all gliders except for Heavy Duty
 Silver Code: 16WSOLI-
 Packed: 1 Min Qty: 1



Heavy Duty Underlap Arm ^Δ 6mm Channel
 White Code: 16HD301W
 Packed: 10 Min Qty: 10



Heavy Duty Overlap Arm ^Δ 6mm Channel
 White Code: 16HD303W
 Packed: 10 Min Qty: 10

^Δ Compatible when using Heavy Duty Gliders **ONLY**

DISCLAIMER: Whilst every effort has been made to ensure colour accuracy, due to the limitations of colour printing, please refer to product samples for colour matching. Product dimensions are for guidance only and may differ – please confirm details at time of ordering.

Cubicle Rail Aluminium Track – Accessories

Additional Tools



Cubicle Rail Notching Tool

A special cutting tool to create notches in your cubicle rail to allow additional gliders to be added or taken away from your track easily without having to dismantle or remove from it's installed position.

Code: I6HONTCH

Packed: 1 Min Qty: 1



Notching Tool Hole V-Spring Covers

To fill the gaps left by the notching tool and allows installed gliders to work as normal.

Code: I6HONTST

Packed: 1 Min Qty: 1

Cubicle Curtains



Disposable Cubicle Curtains Blue

With Antimicrobial Protection
100% Recyclable Polypropylene Non-woven
Curtains have a drop of 2m. See full details below.

Width: 7.5m (Can be cut to smaller size)

Certified to BS5867-2:2008 Type C

Code: I6HODICTN75B

Packed: 10 Min Qty: 10



Are you looking
for Medi Gliders?

PLEASE SEE PAGE 220

Bends & Bending



Table Mounted Bending Tool for Cubicle Rail (includes 1 set of bending inserts)

Internal & external bends can be formed

Code: I6HOSBEN

Packed: 1 Min Qty: 1



Large Portable Bending Tool for Optimal H-Section, Principal H-Section, Professional Large Curved Profile, W-Section Profile, Heavy Duty H-Section Profile and Cubicle Rail (includes 1 set of bending inserts)

Internal & external bends can be formed

Code: I6MPLBEN

Packed: 1 Min Qty: 1



Spare Bending Inserts for Cubicle Rail (50cm set of 2 pieces)

Insert into the glider & bracket channel of aluminium track to prevent damage to the channel when bending

Code: I6HOINST

Packed: 1 Min Qty: 1



Made-to-Measure Cutting Service

Code: I6MTMTRK

Cubicle Rail Bending Service:

Single Angle Bend

Code: I6HOBEND

Continuous Curve

Code: I6HOCONT



See p226 for details on how to download Cubicle Rail bending form

Disposable Cubicle Curtains

With Antimicrobial Protection



Flame Retardant



100% Recyclable Material



Antimicrobial Protection

Curtain Material 100% Recyclable Polypropylene Non-woven

Sizes Width: 7.5m (Can be cut to smaller size)
Drop: 2m

Key Features

- Supplied in a hygienic protective polythene wrapper – once curtains are hung the wrapper is simple to remove.
- No individual fitting of hangers required.
- Supplied with clear Audit Date Labels.
- Pre-fitted holdbacks help to keep Curtains securely folded away when not in use.
- Certified to BS5867-2:2008 Type C
- Treated with antimicrobial protection

Disposable Cubicle Curtains are made from 100% Recyclable Polypropylene Non-woven material which meets with British Flame retardant standards. They are also treated with ultra-fresh antimicrobial protection.



DISCLAIMER: Whilst every effort has been made to ensure colour accuracy, due to the limitations of colour printing, please refer to product samples for colour matching. Product dimensions are for guidance only and may differ – please confirm details at time of ordering.



RENAISSANCE

TEL 0113 250 4499

• EMAIL SALES@RCA-UK.COM

• VISIT RCA-UK.COM

145

Motiva Flat

Aluminium Profile Track

Motiva Flat is the curtain track with a modern touch that truly stands out. With it's tall, sleek design it brings a contemporary edge to traditional window treatments. Available in our core choice of three colours, competitively priced, Motiva Flat is ideal for the contract market where enhanced design and economy of cost are required.

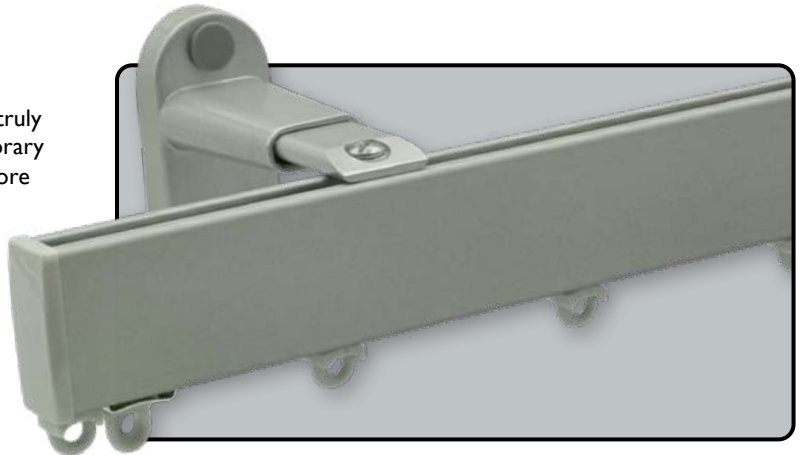

For Curtain Hooks see this Catalogue page 217



Motiva Flat Aluminium Profile Track 6mm Channel

- Size: 6m (19'8") White Code: I6MF600W
- Size: 6m (19'8") Silver Code: I6MF600T
- Size: 6m (19'8") Black Code: I6MF600K
- Packed: 10 Lengths Min Qty: 10

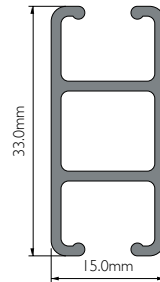

Colour finishes available:

WHITE RAL 9016	W
SILVER RAL 9006	T
BLACK RAL 9005	K

Insert your chosen colour letter reference at end of the Kit Code.

Profile Weight: 359g/m

Made-to-measure Kits include Track, Brackets, Gliders, End Caps & End Stops. An essential time saver for professional fitters – see table below for details.

Motiva Flat Aluminium Profile Track Kit Components

NOTE: Kits are available up to the size ordered and can also be produced to your specific size.

Components	Track Kit Sizes							
	1.00m (3'3")	1.50m (4'11")	2.00m (6'7")	2.50m (8'2")	3.00m* (9'10")	4.00m* (13'1")	5.00m* (16'5")	6.00m* (19'8")
Profile Track	1 x 1.00m	1 x 1.50m	1 x 2.00m	1 x 2.50m	2 x 1.50m	2 x 2.00m	2 x 2.50m	2 x 3.00m
Ceiling Brackets	2	3	4	4	5	7	9	10
8-12cm Adj Wall Brackets	2	2	3	4	4	5	7	8
End Caps	2	2	2	2	2	2	2	2
Gliders^	10	16	20	26	30	40	50	60
Twist End Stops	2	2	2	2	2	2	2	2
Standard Glider Kit Code†	16MFUS100_	16MFUS150_	16MFUS200_	16MFUS250_	16MFUS300_	16MFUS400_	16MFUS500_	16MFUS600_
Roller Glider Kit Code	16MFUR100_	16MFUR150_	16MFUR200_	16MFUR250_	16MFUR300_	16MFUR400_	16MFUR500_	16MFUR600_
60mm SurgeWave Kit Code†	16MFU6100_	16MFU6150_	16MFU6200_	16MFU6250_	16MFU6300_	16MFU6400_	16MFU6500_	16MFU6600_
80mm SurgeWave Kit Code†	16MFU8100_	16MFU8150_	16MFU8200_	16MFU8250_	16MFU8300_	16MFU8400_	16MFU8500_	16MFU8600_
Roller Surge 60 Kit Code†	16MFURS6100_	16MFURS6150_	16MFURS6200_	16MFURS6250_	16MFURS6300_	16MFURS6400_	16MFURS6500_	16MFURS6600_
Roller Surge 80 Kit Code†	16MFURS8100_	16MFURS8150_	16MFURS8200_	16MFURS8250_	16MFURS8300_	16MFURS8400_	16MFURS8500_	16MFURS8600_
Surge Ribbon 60 Kit Code†	16MFURB6100_	16MFURB6150_	16MFURB6200_	16MFURB6250_	16MFURB6300_	16MFURB6400_	16MFURB6500_	16MFURB6600_
Surge Ribbon 80 Kit Code†	16MFURB8100_	16MFURB8150_	16MFURB8200_	16MFURB8250_	16MFURB8300_	16MFURB8400_	16MFURB8500_	16MFURB8600_

Packed: 1 px / Outer 5 Min Qty: 1

NOTE: Kits come with 10 gliders per m unless otherwise specified.

† Insert your chosen colour letter reference at end of the Kit Code and Surge code.

Motiva Flat kits are supplied with Ceiling Brackets **or** 8-12cm Adjustable Wall Brackets as standard – alternative designs are available on request.

* Denotes 2 piece profile with joiner – single length kits up to 6m are available but must be requested at time of ordering. All kits include fittings.

^ For SurgeWave Kits the gliders are replaced with SurgeWave Gliders-on-a-string or SurgeWave Ribbon Gliders – see **p176-177** to calculate the number of SurgeWave Gliders required.

	This curtain track is suitable for medium-to-heavy weight curtains		Suitable for straight runs and can also be bent		Kits/components are delivered in transport packaging		Available in contract components for large jobs		Available in kit form for simple ordering		Tracks available made-to-measure
--	--	--	---	--	--	--	---	--	---	--	----------------------------------

DISCLAIMER: Whilst every effort has been made to ensure colour accuracy, due to the limitations of colour printing, please refer to product samples for colour matching. Product dimensions are for guidance only and may differ – please confirm details at time of ordering.

Motiva Flat Aluminium Track – Accessories

Motiva Brackets



Motiva Ceiling Bracket

- White Code: 16MOBCCW
 - Silver Code: 16MOBCCCT
 - Black Code: 16MOBCCCK
- Packed: 100 Min Qty: 10



Motiva Extendable 8–12cm Wall Bracket

- White Code: 16MOB3CW
 - Silver Code: 16MOB3CT
 - Black Code: 16MOB3CK
- Packed: 100 Min Qty: 10

S 80mm

S 60mm



Motiva Extendable 15–19cm Wall Bracket

- White Code: 16MOB6CW
 - Silver Code: 16MOB6CT
 - Black Code: 16MOB6CK
- Packed: 100 Min Qty: 10

S 80mm

S 60mm

Includes additional Screw for Double Track usage



Motiva Flat Recess Bracket

- Grey Code: 16HO018T
 - White Code: 16HO018W
 - Black Code: 16MF018K
- Packed: 100 Min Qty: 10

End Cap & End Stops



Motiva Flat End Cap

- White Code: 16MFEC CW
 - Silver Code: 16MFEC CT
 - Black Code: 16MFEC CK
- Packed: 100 Min Qty: 100



Large Metal Mid Stop for 6mm Channel

- Silver Code: 16HO044S
- Packed: 100 Min Qty: 100



Large Twist-Fit End Stop for 6mm Channel

- White Code: 16HO744W
 - Grey Code: 16HO744T
 - Black Code: 16HO744K
- Packed: 100 Min Qty: 100



Large Metal Twist Stop for 6mm Channel

- Silver Code: 16HO997S
- Packed: 100 Min Qty: 100

Track Joiner



Motiva Flat Profile Joiner

- Silver Code: 16HO002S
- Packed: 25 Min Qty: 10

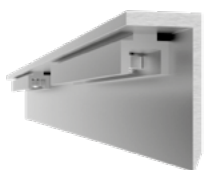

Motiva Flat 30cm Bridge for joining on bends

- White Code: 16HO014W
 - Silver Code: 16HO014T
 - Black Code: 16HO014K
- Packed: 1 Min Qty: 1

Track Cover

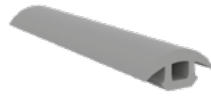

PVC Profile Top Cover

- Grey Code: 16HO016T
 - White Code: 16HO016W
- Packed: 50m Approx Min Qty: 10m

Gliders

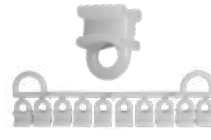

Standard Gliders – Strips of 10 6mm Channel

- White Code: 16HO738W
 - Grey Code: 16HO738T
 - Black Code: 16HO738K
- Packed: 2000 Min Qty: 1000



Roller Gliders – Strips of 10 for 6mm Channel

- White Packed: 100 Code: 16HO025W
 - White Packed: 1000 Code: 16HO025KW
- Min Qty: 100

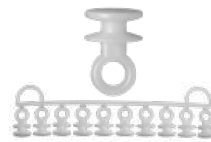

Caraglidars – Strips of 10 6mm Channel

- White Code: 16HO999W
- Packed: 1000 Min Qty: 1000



Heavy Duty Gliders for 6mm Channel

- White Code: 16HD307W
- Packed: 100 Min Qty: 10



Click-in Glider for 6mm Channel

- White Code: 16HO998W
- Packed: 1000 Min Qty: 1000

SurgeWave® System Gliders

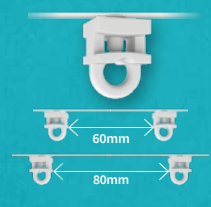

SurgeWave® System Gliders-on-a-String for 6mm Channel

- White Spacing: 60mm Code: 16HH60GLST
 - White Spacing: 80mm Code: 16HH80GLST
 - Black Spacing: 60mm Code: 16HH60GLSK
 - Black Spacing: 80mm Code: 16HH80GLSK
- Packed: 25m Min Qty: 25m

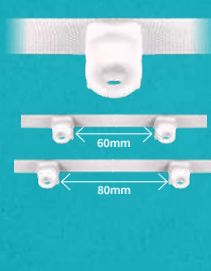

SurgeWave® System Ribbon Gliders for 6mm Channel

- White Spacing: 60mm Code: 16SW6RG60W
 - White Spacing: 80mm Code: 16SW6RG80W
 - Grey Spacing: 60mm Code: 16SW6RG60G
 - Grey Spacing: 80mm Code: 16SW6RG80G
 - Black Spacing: 60mm Code: 16SW6RG60K
 - Black Spacing: 80mm Code: 16SW6RG80K
- Packed: 25m Min Qty: 25m



SurgeWave® Roller Gliders-on-a-String (Narrow) for 6mm Channel

- White Spacing: 60mm Code: 16GL6SR60W
 - White Spacing: 80mm Code: 16GL6SR80W
- Packed: 30m Min Qty: 30m



SurgeWave® Click-In End Lock 6mm Channel

- Clear Code: 16SUESCW
- Packed: 100 Min Qty: 100

See overleaf for more Motiva Flat SurgeWave® System Accessories

DISCLAIMER: Whilst every effort has been made to ensure colour accuracy, due to the limitations of colour printing, please refer to product samples for colour matching. Product dimensions are for guidance only and may differ – please confirm details at time of ordering.

Motiva Flat Aluminium Track – Accessories

SurgeWave® System Accessories



SurgeWave® System Curtain Tape

With 60mm & 80mm Spacing Guides

<input type="checkbox"/> White	Packed: 50m	Code: 51TOWA3R
<input type="checkbox"/> White	Packed: 100m	Code: 51TOWA3CR
<input type="checkbox"/> Black	Packed: 50m	Code: 51TOWAK3R
Min Qty: 100m		



Iron-on SurgeWave® System Curtain Tape

<input type="checkbox"/> White	Packed: 50m	Code: 51TOWIA3R
Min Qty: 100m		



Friction Gliders for SurgeWave® System

NOTE: **Not** compatible with Ribbon Gliders

<input type="checkbox"/> White	Packed: 10	Code: 16HSFGDW
<input type="checkbox"/> White	Packed: 100	Code: 16HSFGCW
<input type="checkbox"/> Grey	Packed: 10	Code: 16HSFGDT
<input type="checkbox"/> Grey	Packed: 100	Code: 16HSFGCT
<input type="checkbox"/> Black	Packed: 10	Code: 16HSFGDK
<input type="checkbox"/> Black	Packed: 100	Code: 16HSFGCK

Helps prevent curtain spring-back



Neat Pleat Guide for SurgeWave® System

Clips onto 4mm & 6mm SurgeWave Gliders

<input type="checkbox"/> White	Code: 16SURNP-
Packed: 10	Min Qty: 10

For more details on how the SurgeWave® System works please see pages 165–180 in this Catalogue



Gliders with S-Hooks & Overlap Arms



Standard Gliders with Large Metal S-Hook

<input type="checkbox"/> White	Code: 16HO996W
Packed: 100	Min Qty: 100



Standard Gliders with Small Metal S-Hook

<input type="checkbox"/> White	Code: 16HO990W
Packed: 100	Min Qty: 100



Caraglidars with Large Metal S-Hook

<input type="checkbox"/> White	Code: 16HO994W
Packed: 100	Min Qty: 100

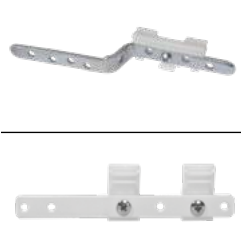

Caraglidars with Large Plastic S-Hook

<input type="checkbox"/> White	Code: 16HO991W
Packed: 100	Min Qty: 100



These Glider Attachments can be added to gliders with an 'eye' to connect to curtains

Plastic S-Hook	Code: 16HO995W
Packed: 1000	Min Qty: 1000

Large Metal S-Hook 39mm Code: 16HO072S

Small Metal S-Hook 29mm Code: 16HO071S

Packed: 100	Min Qty: 100
-------------	--------------



6mm Overlap Arm

Compatible with all gliders except for Heavy Duty

<input type="checkbox"/> Silver	Code: 16WSOLI-
Packed: 1	Min Qty: 1



Heavy Duty Underlap Arm ^Δ 6mm Channel

<input type="checkbox"/> White	Code: 16HD301W
Packed: 10	Min Qty: 10



Heavy Duty Overlap Arm ^Δ 6mm Channel

<input type="checkbox"/> White	Code: 16HD303W
Packed: 10	Min Qty: 10

^Δ Compatible when using Heavy Duty Gliders **ONLY**

Suspended Brackets

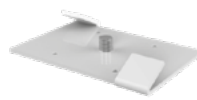

Suspended Ceiling Bracket

Used with tracks or blinds to fix to suspended ceilings.

<input type="checkbox"/> White	Code: 16HSSCCW
Packed: 100	Min Qty: 10



16mm Tube complete Ceiling Support

Size: 100cm (3'3")	<input type="checkbox"/> Silver	Code: 16HOC10T
Size: 100cm (3'3")	<input type="checkbox"/> Black	Code: 16HOC10K
Size: 100cm (3'3")	<input type="checkbox"/> White	Code: 16HOC10W
Size: 125cm (4'1")	<input type="checkbox"/> Silver	Code: 16HOC13T
Size: 125cm (4'1")	<input type="checkbox"/> Black	Code: 16HOC13K
Size: 125cm (4'1")	<input type="checkbox"/> White	Code: 16HOC13W
Size: 150cm (4'11")	<input type="checkbox"/> Silver	Code: 16HOC15T
Size: 150cm (4'11")	<input type="checkbox"/> Black	Code: 16HOC15K
Size: 150cm (4'11")	<input type="checkbox"/> White	Code: 16HOC15W
Size: 175cm (5'9")	<input type="checkbox"/> Silver	Code: 16HOC18T
Size: 175cm (5'9")	<input type="checkbox"/> Black	Code: 16HOC18K
Size: 175cm (5'9")	<input type="checkbox"/> White	Code: 16HOC18W
Size: 200cm (6'7")	<input type="checkbox"/> Silver	Code: 16HOC20T
Size: 200cm (6'7")	<input type="checkbox"/> Black	Code: 16HOC20K
Size: 200cm (6'7")	<input type="checkbox"/> White	Code: 16HOC20W
Packed: 10	Min Qty: 10	

16mm Tube Ceiling Support is also available in component form for Motiva Flat – please see Motiva Round page 153 for details

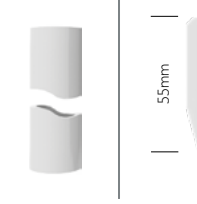

V-Hanger Complete

Drop: 80cm (2'7")	<input type="checkbox"/> Silver	Code: 16HOV08T
Drop: 80cm (2'7")	<input type="checkbox"/> Black	Code: 16HOV08K
Drop: 80cm (2'7")	<input type="checkbox"/> White	Code: 16HOV08W
Drop: 100cm (3'3")	<input type="checkbox"/> Silver	Code: 16HOV10T
Drop: 100cm (3'3")	<input type="checkbox"/> Black	Code: 16HOV10K
Drop: 100cm (3'3")	<input type="checkbox"/> White	Code: 16HOV10W
Drop: 150cm (4'11")	<input type="checkbox"/> Silver	Code: 16HOV15T
Drop: 150cm (4'11")	<input type="checkbox"/> Black	Code: 16HOV15K
Drop: 150cm (4'11")	<input type="checkbox"/> White	Code: 16HOV15W
Packed: 1	Min Qty: 1	

Bending Service



Made-to-Measure Cutting Service

Code: 16MTMTRK

Motiva Flat Track Bending Service:

Single Angle Bend	Code: 16MFBEND
Continuous Curve	Code: 16MFCONT

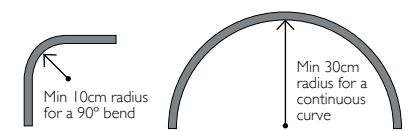

Please see page 227 for the Renaissance Metal Track Bending Form

DISCLAIMER: Whilst every effort has been made to ensure colour accuracy, due to the limitations of colour printing, please refer to product samples for colour matching. Product dimensions are for guidance only and may differ – please confirm details at time of ordering.

Motiva Round Uncorded Aluminium Profile Track

Motiva Round is a heavy duty 28mm pole style track and is available in our core choice of three colours. Competitively priced, Motiva Round offers the benefits of tracking with the aesthetically pleasing appearance of a pole, and is ideal for the contract market where enhanced design and economy of cost are required. Motiva Round can also be used to create cubicles.

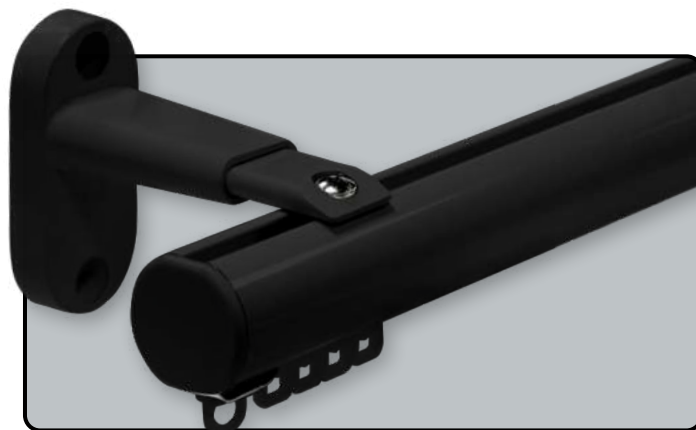

Profile Weight: 473g/m

Motiva Round Uncorded Aluminium Profile Track 6mm Channel

- Size: 6m (19'8") White Code: 16MO600W
 - Size: 6m (19'8") Silver Code: 16MO600T
 - Size: 6m (19'8") Black Code: 16MO600K
- Packed: 20 Min Qty: 10

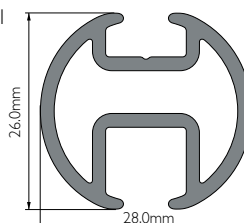

Colour finishes available:

WHITE RAL 9016	W
SILVER RAL 9006	T
BLACK RAL 9005	K

Insert your chosen colour letter reference at end of the Kit Code.

Motiva Round Finials

Metal End Cap & Ball Finials are also available as an optional extra.

See Motiva Round components on p151

Note: Ceiling Fix is not compatible for Ball Finials



Made-to-measure Kits include Track, Brackets, Gliders, End Caps & End Stops. An essential time saver for professional fitters – see table below for details.

Motiva Round Uncorded Aluminium Profile Track Kit Components

NOTE: Kits are available up to the size ordered and can also be produced to your specific size.

Components	Track Kit Sizes							
	1.00m (3'3")	1.50m (4'11")	2.00m (6'7")	2.50m (8'2")	3.00m* (9'10")	4.00m* (13'1")	5.00m* (16'5")	6.00m* (19'8")
Profile Track	1 x 1.00m	1 x 1.50m	1 x 2.00m	1 x 2.50m	2 x 1.50m	2 x 2.00m	2 x 2.50m	2 x 3.00m
Ceiling Brackets	2	3	4	4	5	7	9	10
8-12cm Adj Wall Brackets	2	2	3	4	4	5	7	8
End Caps	2	2	2	2	2	2	2	2
Twist End Stops	2	2	2	2	2	2	2	2
Gliders^	10	16	20	26	30	40	50	60
Standard Glider Kit Code †	16MOUS100_	16MOUS150_	16MOUS200_	16MOUS250_	16MOUS300_	16MOUS400_	16MOUS500_	16MOUS600_
Roller Glider Kit Code †	16MOUR100_	16MOUR150_	16MOUR200_	16MOUR250_	16MOUR300_	16MOUR400_	16MOUR500_	16MOUR600_
60mm SurgeWave Kit Code †	16MOU6100_	16MOU6150_	16MOU6200_	16MOU6250_	16MOU6300_	16MOU6400_	16MOU6500_	16MOU6600_
80mm SurgeWave Kit Code †	16MOU8100_	16MOU8150_	16MOU8200_	16MOU8250_	16MOU8300_	16MOU8400_	16MOU8500_	16MOU8600_
Roller Surge 60 Kit Code †	16MOURS6100_	16MOURS6150_	16MOURS6200_	16MOURS6250_	16MOURS6300_	16MOURS6400_	16MOURS6500_	16MOURS6600_
Roller Surge 80 Kit Code †	16MOURS8100_	16MOURS8150_	16MOURS8200_	16MOURS8250_	16MOURS8300_	16MOURS8400_	16MOURS8500_	16MOURS8600_
Surge Ribbon 60 Kit Code †	16MOURB6100_	16MOURB6150_	16MOURB6200_	16MOURB6250_	16MOURB6300_	16MOURB6400_	16MOURB6500_	16MOURB6600_
Surge Ribbon 80 Kit Code †	16MOURB8100_	16MOURB8150_	16MOURB8200_	16MOURB8250_	16MOURB8300_	16MOURB8400_	16MOURB8500_	16MOURB8600_

Packed: 1 px / Outer 5 Min Qty: 1

NOTE: Kits come with 10 gliders per m unless otherwise specified.

† Insert your chosen colour letter reference at end of the Kit Code and Surge code.

Motiva Round kits are supplied with Ceiling Brackets or 8-12cm Adjustable Wall Brackets as standard – alternative designs are available on request.

* Denotes 2 piece profile with joiner – single length kits up to 6m are available but must be requested at time of ordering. All kits include fittings.

^For SurgeWave Kits the gliders are replaced with SurgeWave Gliders-on-a-string or SurgeWave Ribbon Gliders – see p176-177 to calculate the number of SurgeWave Gliders required.



This curtain track is suitable for medium-to-heavy weight curtains

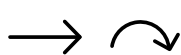

Suitable for straight runs and can also be bent



Kits/components are delivered in transport packaging



Available in contract components for large jobs



Available in kit form for simple ordering



Tracks available made-to-measure

DISCLAIMER: Whilst every effort has been made to ensure colour accuracy, due to the limitations of colour printing, please refer to product samples for colour matching. Product dimensions are for guidance only and may differ – please confirm details at time of ordering.

Motiva Round Corded Aluminium Profile Track

Motiva Round, our heavy duty 28mm pole style track, is also available as a Corded Track. Ideal for domestic, institutional or commercial curtains where simplicity is by design. Motiva may be specified with our Surge wave curtain system which complements any décor.



For Curtain Hooks see this Catalogue page 217



Motiva Round Corded Aluminium Profile Track 6mm Channel

- Size: 6m (19'8") White Code: I6MC600W
 - Size: 6m (19'8") Silver Code: I6MC600T
 - Size: 6m (19'8") Black Code: I6MC600K
- Packed: 20 Min Qty: 10

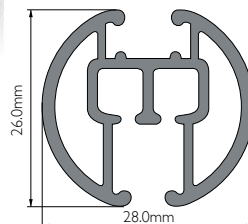

Colour finishes available:

WHITE RAL 9016	W
SILVER RAL 9006	T
BLACK RAL 9005	K

Insert your chosen colour letter reference at end of the Kit Code.

Profile Weight: 432g/m

Motiva Round Finials

Metal End Cap & Ball Finials are also available as an optional extra.

See Motiva Round components on p151

Note: Ceiling Fix is not compatible for Ball Finials



Made-to-measure Corded Kits include Track, Brackets, Gliders, End Caps, End Stops and Overlap Arms. An essential time saver for professional fitters – see table below for details.

Motiva Round Corded Aluminium Profile Track Kit Components

NOTE: Kits are available up to the size ordered and can also be produced to your specific size.

Components	Track Kit Sizes							
	1.00m (3'3")	1.50m (4'11")	2.00m (6'7")	2.50m (8'2")	3.00m* (9'10")	4.00m* (13'1")	5.00m* (16'5")	6.00m* (19'8")
Profile Track	1 x 1.00m	1 x 1.50m	1 x 2.00m	1 x 2.50m	2 x 1.50m	2 x 2.00m	2 x 2.50m	2 x 3.00m
8-12cm Wall Brackets	2	3	4	5	5	6	7	8
End Caps	2	2	2	2	2	2	2	2
Twist End Stops	2	2	2	2	2	2	2	2
Gliders^	10	16	20	26	30	40	50	60
Heavy Duty Glider Kit Code †	16MOCs100_	16MOCs150_	16MOCs200_	16MOCs250_	16MOCs300_	16MOCs400_	16MOCs500_	16MOCs600_
Roller Glider Kit Code †	16MOCr100_	16MOCr150_	16MOCr200_	16MOCr250_	16MOCr300_	16MOCr400_	16MOCr500_	16MOCr600_
60mm SurgeWave Kit Code †	16MOC6100_	16MOC6150_	16MOC6200_	16MOC6250_	16MOC6300_	16MOC6400_	16MOC6500_	16MOC6600_
80mm SurgeWave Kit Code †	16MOC8100_	16MOC8150_	16MOC8200_	16MOC8250_	16MOC8300_	16MOC8400_	16MOC8500_	16MOC8600_
Roller Surge 60 Kit Code †	16MOCrs6100_	16MOCrs6150_	16MOCrs6200_	16MOCrs6250_	16MOCrs6300_	16MOCrs6400_	16MOCrs6500_	16MOCrs6600_
Roller Surge 80 Kit Code †	16MOCrs8100_	16MOCrs8150_	16MOCrs8200_	16MOCrs8250_	16MOCrs8300_	16MOCrs8400_	16MOCrs8500_	16MOCrs8600_
Surge Ribbon 60 Kit Code †	16MOCrb6100_	16MOCrb6150_	16MOCrb6200_	16MOCrb6250_	16MOCrb6300_	16MOCrb6400_	16MOCrb6500_	16MOCrb6600_
Surge Ribbon 80 Kit Code †	16MOCrb8100_	16MOCrb8150_	16MOCrb8200_	16MOCrb8250_	16MOCrb8300_	16MOCrb8400_	16MOCrb8500_	16MOCrb8600_

Packed: 1 px / Outer 5 Min Qty: 1

NOTE: Kits come with 10 gliders per m unless otherwise specified.

† Insert your chosen colour letter reference at end of the Kit Code.

* Denotes 2 piece profile with joiner – single length kits up to 6m are available but must be requested at time of ordering. All kits include fittings.

^ For SurgeWave Kits the gliders are replaced with SurgeWave Gliders-on-a-string or SurgeWave Ribbon Gliders – see p176-177 to calculate the number of SurgeWave Gliders required.

<p>KG MEDIUM HEAVY</p>	<p>This curtain track is suitable for medium-to-heavy weight curtains</p>	<p>Suitable for straight runs and can also be bent</p>	<p>Kits/components are delivered in transport packaging</p>	<p>Available in contract components for large jobs</p>	<p>Available in kit form for simple ordering</p>	<p>Tracks available made-to-measure</p>
---------------------------------------	---	--	---	--	--	---

DISCLAIMER: Whilst every effort has been made to ensure colour accuracy, due to the limitations of colour printing, please refer to product samples for colour matching. Product dimensions are for guidance only and may differ – please confirm details at time of ordering.

Motiva Round Aluminium Profile Track – Accessories

Motiva Brackets

Motiva Ceiling Bracket



White Code: 16MOBCCW
 Silver Code: 16MOBCCCT
 Black Code: 16MOBCCCK
 Packed: 100 Min Qty: 10



Motiva Extendable 8–12cm Wall Bracket



White Code: 16MOB3CW
 Silver Code: 16MOB3CT
 Black Code: 16MOB3CK
 Packed: 100 Min Qty: 10



Motiva Extendable 15–19cm Wall Bracket



White Code: 16MOB6CW
 Silver Code: 16MOB6CT
 Black Code: 16MOB6CK
 Packed: 100 Min Qty: 10



Includes additional Screw for Double Track usage

Motiva Round Plastic Recess Bracket



White Code: 16MORBCW
 Silver Code: 16MORBCT
 Black Code: 16MORBCK
 Packed: 100 Min Qty: 10



End Cap & End Stops

Motiva Round Uncorded Plastic End Cap



White Code: 16MOECCW
 Black Code: 16MOECCCK
 Grey Code: 16MOECCCT
 Packed: 100 Min Qty: 10

Motiva Round Corded Plastic End Cap



White Code: 16MCEC1W
 Black Code: 16MCEC1K
 Grey Code: 16MCEC1G
 Packed: 100 Min Qty: 10

Large Metal Mid Stop for 6mm Channel



Silver Code: 16HO044S
 Packed: 100 Min Qty: 100

Large Twist Fit End Stop for 6mm Channel



White Code: 16HO744W
 Grey Code: 16HO744T
 Black Code: 16HO744K
 Packed: 100 Min Qty: 100

Not compatible with Corded

Large Metal Twist Stop for 6mm Channel



Silver Code: 16HO997S
 Packed: 100 Min Qty: 100

SurgeWave® Click-In End Lock



SurgeWave® Click-In End Lock 6mm Channel
 Clear Code: 16SUESCW
 Packed: 100 Min Qty: 100

Motiva Metal End Caps & Finials

Motiva Round Metal End Cap



White Code: 16MOAECW
 Black Code: 16MOAECK
 Silver Code: 16MOAECT
 Packed: 100 Min Qty: 10

Motiva Round Metal Ball Finial



White Code: 16MOABCW
 Black Code: 16MOABCK
 Silver Code: 16MOABCT
 Packed: 100 Min Qty: 10

Track Joiner

Motiva Round Profile Track Joiner



Silver Code: 16MOJOIN
 Packed: 1 Min Qty: 1

Motiva Corded Accessories & Safety Accessories

Motiva Corded Overlap Arm with Swivel Gliders



Specially designed for smooth running on curves
 Code: 16MCOLAR
 Packed: 10 Min Qty: 10
 Compatible with Integrated Cord Mechanism below

Motiva Corded Integrated Mechanism Set of 2



Specially designed to fit discretely inside the track
 Code: 16MCCORM
 Packed: 10 Min Qty: 10

Motiva Corded Profile Cord Connector



White Code: 16HD306W
 Packed: 10 Min Qty: 10

Motiva Corded Heavy Duty Cord 3.2mm



White Code: 16MOC32W
 Black Code: 16MOC32K
 Packed: 500m Min Qty: 10m

Safety Boxes



Single Safety Box Code: 58WASBSG
 Double Safety Box Code: 58WASBDB
 Packed: 100 Min Qty: 10

Safety Warning Tag with string



Code: 58WASTST
 Packed: 100 Min Qty: 10

Clear Safety Cord Guide



Code: 58WASCCL
 Packed: 100 Min Qty: 100

Cord Tensioners



White
 Plastic Tensioner Code: 18CTCTPW
 Metal Tensioner Code: 18CTCTMW
 Packed: 1 px / Outer 10

DISCLAIMER: Whilst every effort has been made to ensure colour accuracy, due to the limitations of colour printing, please refer to product samples for colour matching. Product dimensions are for guidance only and may differ – please confirm details at time of ordering.

Motiva Round Aluminium Profile Track – Accessories

Gliders & Overlap Arms



Standard Gliders – Strips of 10 6mm Channel

- White Code: 16HO738W
 - Grey Code: 16HO738T
 - Black Code: 16HO738K
- Packed: 2000 Min Qty: 1000



Roller Gliders – Strips of 10 for 6mm Channel

- White Packed: 100 Code: 16HO025W
 - White Packed: 1000 Code: 16HO025KW
- Min Qty: 100

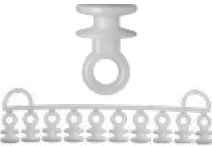

Caraglidars – Strips of 10 6mm Channel

- White Code: 16HO999W
- Packed: 1000 Min Qty: 1000



Heavy Duty Gliders for 6mm Channel

- White Code: 16HD307W
- Packed: 100 Min Qty: 10



Motiva Heavy Duty Roller Glider For Motiva Uncorded Profile ONLY

- White Code: 16HO992W
- Packed: 100 Min Qty: 100



Click-in Glider for 6mm Channel

- White Code: 16HO998W
- Packed: 1000 Min Qty: 1000



Standard Gliders with Large Metal S-Hook

- White Code: 16HO996W
- Packed: 100 Min Qty: 100



Standard Gliders with Small Metal S-Hook

- White Code: 16HO990W
- Packed: 100 Min Qty: 100



Caraglidars with Large Metal S-Hook

- White Code: 16HO994W
- Packed: 100 Min Qty: 100



Caraglidars with Large Plastic S-Hook

- White Code: 16HO991W
- Packed: 100 Min Qty: 100

Overlap Arms – Motiva Uncorded Only



6mm Overlap Arm

- Compatible with all gliders except for Heavy Duty
- Silver Code: 16WSOLI-
- Packed: 1 Min Qty: 1



Heavy Duty Underlap Arm ^Δ 6mm Channel

- White Code: 16HD301W
- Packed: 10 Min Qty: 10



Heavy Duty Overlap Arm ^Δ 6mm Channel

- White Code: 16HD303W
- Packed: 10 Min Qty: 10

^Δ Compatible when using Heavy Duty Gliders **ONLY**

SurgeWave[®] System Gliders & Accessories

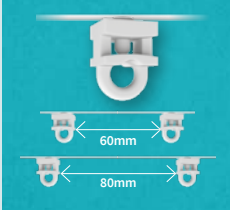

SurgeWave[®] System Gliders-on-a-String for 6mm Channel

- White Spacing: 60mm Code: 16HH60GLST
 - White Spacing: 80mm Code: 16HH80GLST
 - Black Spacing: 60mm Code: 16HH60GLSK
 - Black Spacing: 80mm Code: 16HH80GLSK
- Packed: 25m Min Qty: 25m

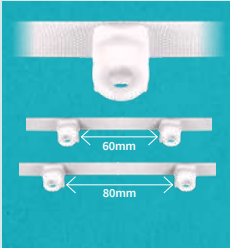

SurgeWave[®] Ribbon Gliders for 6mm Channel

- White Spacing: 60mm Code: 16SW6RG60W
 - White Spacing: 80mm Code: 16SW6RG80W
 - Grey Spacing: 60mm Code: 16SW6RG60G
 - Grey Spacing: 80mm Code: 16SW6RG80G
 - Black Spacing: 60mm Code: 16SW6RG60K
 - Black Spacing: 80mm Code: 16SW6RG80K
- Packed: 25m Min Qty: 25m



SurgeWave[®] Roller Gliders-on-a-String (Narrow) for 6mm Channel

- White Spacing: 60mm Code: 16GL6SR60W
 - White Spacing: 80mm Code: 16GL6SR80W
- Packed: 30m Min Qty: 30m



SurgeWave[®] System Curtain Tape

- With 60mm & 80mm Spacing Guides
- White Packed: 50m Code: 51TOWA3R
 - White Packed: 100m Code: 51TOWA3CR
 - Black Packed: 50m Code: 51TOWAK3R
- Min Qty: 100m



Iron-on SurgeWave[®] System Curtain Tape

- White Packed: 50m Code: 51TOWIA3R
- Min Qty: 100m



Friction Gliders for SurgeWave[®] System

- NOTE: Not compatible with Ribbon Gliders
- White Packed: 10 Code: 16HSFGDW
 - White Packed: 100 Code: 16HSFGCW
 - Grey Packed: 10 Code: 16HSFGDT
 - Grey Packed: 100 Code: 16HSFGCT
 - Black Packed: 10 Code: 16HSFGDK
 - Black Packed: 100 Code: 16HSFGCK
- Helps prevent curtain spring-back

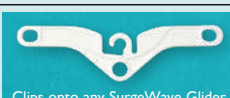

Neat Pleat Guide for SurgeWave[®] System

- White Code: 16SURNP-
- Packed: 10 Min Qty: 10

For more details on how the SurgeWave[®] System works please see pages 165–180 in this Catalogue



Bending & Cutting Service



Made-to-Measure Cutting Service Code: 16MTMTRK

- Motiva Uncorded Track Bending Service:**
- Single Angle Bend Code: 16MOBEND
 - Continuous Curve Code: 16MOCONT

- Motiva Corded Track Bending Service:**
- Single Angle Bend Code: 16MCBEND
 - Continuous Curve Code: 16MCCONT



Please see page 227 for the Renaissance Metal Track Bending Form

DISCLAIMER: Whilst every effort has been made to ensure colour accuracy, due to the limitations of colour printing, please refer to product samples for colour matching. Product dimensions are for guidance only and may differ – please confirm details at time of ordering.

Motiva Round Aluminium Profile Track – Accessories

Motiva Round Joiners



T-Join Connecting Piece/Ceiling Fix Bracket
Remove 2 screws for ceiling fix

- White Code: 16HO015W
 - Silver Code: 16HO015T
 - Black Code: 16HO015K
- Packed: 100 Min Qty: 10



Motiva Round Profile Connection Bridge

- White Code: 16MOJNCW
 - Silver Code: 16MOJNCT
 - Black Code: 16MOJNCK
- Packed: 100 Min Qty: 10



Motiva Round Plastic Recess Bracket

- White Code: 16MORBCW
 - Silver Code: 16MORBCT
 - Black Code: 16MORBCK
- Packed: 100 Min Qty: 10



Motiva Round T-Connector

- White Code: 16MOTCCW
 - Silver Code: 16MOTCCT
 - Black Code: 16MOTCCK
- Packed: 100 Min Qty: 10

Suspended Brackets



Suspended Ceiling Bracket

- Used with tracks or blinds to fix to suspended ceilings.
- White Code: 16HSSCCW
- Packed: 100 Min Qty: 10



16mm Tube for Ceiling Support – 5m (16'5") length

- Silver Code: 16HOF43T
 - Black Code: 16HOF43K
 - White Code: 16HOF43W
- Packed: 10 Lengths Min Qty: 10



16mm Tube/Rail connector for Ceiling Support

- Silver Code: 16HOF45T
 - Black Code: 16HOF45K
 - White Code: 16HOF45W
- Packed: 10 Min Qty: 10



16mm Ceiling/Tube connector for Ceiling Support

- Silver Code: 16HOF42T
 - Black Code: 16HOF42K
 - White Code: 16HOF42W
- Packed: 10 Min Qty: 10



16mm Connector Direct Track/Ceiling

- Silver Code: 16HO939T
 - Black Code: 16HO939K
 - White Code: 16HO939W
- Packed: 10 Min Qty: 10

Suspended Brackets



16mm Tube complete Ceiling Support

- Size: 100cm (3'3") Silver Code: 16HOC10T
 - Size: 100cm (3'3") Black Code: 16HOC10K
 - Size: 100cm (3'3") White Code: 16HOC10W
 - Size: 125cm (4'1") Silver Code: 16HOC13T
 - Size: 125cm (4'1") Black Code: 16HOC13K
 - Size: 125cm (4'1") White Code: 16HOC13W
 - Size: 150cm (4'11") Silver Code: 16HOC15T
 - Size: 150cm (4'11") Black Code: 16HOC15K
 - Size: 150cm (4'11") White Code: 16HOC15W
 - Size: 175cm (5'9") Silver Code: 16HOC18T
 - Size: 175cm (5'9") Black Code: 16HOC18K
 - Size: 175cm (5'9") White Code: 16HOC18W
 - Size: 200cm (6'7") Silver Code: 16HOC20T
 - Size: 200cm (6'7") Black Code: 16HOC20K
 - Size: 200cm (6'7") White Code: 16HOC20W
- Packed: 10 Min Qty: 10



V-Hanger Complete

- Drop: 80cm (2'7") Silver Code: 16HOV08T
 - Drop: 80cm (2'7") Black Code: 16HOV08K
 - Drop: 80cm (2'7") White Code: 16HOV08W
 - Drop: 100cm (3'3") Silver Code: 16HOV10T
 - Drop: 100cm (3'3") Black Code: 16HOV10K
 - Drop: 100cm (3'3") White Code: 16HOV10W
 - Drop: 150cm (4'11") Silver Code: 16HOV15T
 - Drop: 150cm (4'11") Black Code: 16HOV15K
 - Drop: 150cm (4'11") White Code: 16HOV15W
- Packed: 1 Min Qty: 1

DISCLAIMER: Whilst every effort has been made to ensure colour accuracy, due to the limitations of colour printing, please refer to product samples for colour matching. Product dimensions are for guidance only and may differ – please confirm details at time of ordering.

Ocular

Ellipse Profile Track

For those with a true eye for beauty, meet Ocular, the most elegant curtain track you will ever see. The revolutionary ellipse-shaped curtain track combines sophisticated design with modern finishes. Why settle for an ordinary track when you can experience the beauty of Ocular?



For Curtain Hooks see this Catalogue page 217



Ocular Profile Track 6mm Channel

Size: 6m (19'8")

Size: 6m (19'8")

Size: 6m (19'8")

Size: 6m (19'8")

Size: 6m (19'8")

Packed: 20

- Polar
- Dune
- Mist
- Storm
- Noir

Min Qty: 10

Code: I6OC600P

Code: I6OC600D

Code: I6OC600M

Code: I6OC600S

Code: I6OC600N

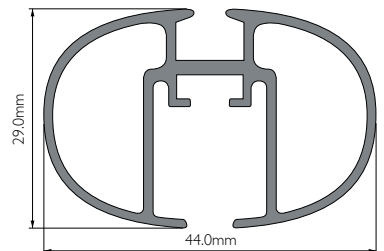

Colour finishes available Insert your chosen colour letter reference at end of the Kit Code.

‡ Indicates closest RAL colour from NCS converter

POLAR RAL 9016	P	DUNE RAL 1019 ‡	D	MIST RAL 9006	M	STORM RAL 7024 ‡	S	NOIR RAL 9005	N
-------------------	----------	--------------------	----------	------------------	----------	---------------------	----------	------------------	----------



Ocular Aluminium Profile Track Kit Components

NOTE: Kits are available up to the size ordered and can also be produced to your specific size.

Components	Track Kit Sizes							
	1.00m (3'3")	1.50m (4'11")	2.00m (6'7")	2.50m (8'2")	3.00m* (9'10")	4.00m* (13'1")	5.00m* (16'5")	6.00m* (19'8")
Profile Track	1 x 1.00m	1 x 1.50m	1 x 2.00m	1 x 2.50m	2 x 1.50m	2 x 2.00m	2 x 2.50m	2 x 3.00m
Ceiling Brackets	2	3	4	4	5	7	9	10
12cm Curved Wall Brackets	2	2	3	4	4	5	7	8
End Caps	2	2	2	2	2	2	2	2
Roller Gliders^	10	16	20	26	30	40	50	60
Twist End Stops**	2	2	2	2	2	2	2	2
Roller Gliders	16OCUPR100_	16OCUPR150_	16OCUPR200_	16OCUPR250_	16OCUPR300_	16OCUPR400_	16OCUPR500_	16OCUPR600_
80mm SurgeWave Rollers	16OCUP8100_	16OCUP8150_	16OCUP8200_	16OCUP8250_	16OCUP8300_	16OCUP8400_	16OCUP8500_	16OCUP8600_

Packed: 1 px / Outer 5 Min Qty: 1

Insert your chosen colour letter reference at end of the Kit Codes (see colour swatches above).

NOTE: Kits come with 10 gliders per m unless otherwise specified.

Ocular kits are supplied with Ceiling Brackets or 12cm Curved Wall Brackets as standard – alternative designs are available on request.

* Denotes 2 piece profile with joiner – single length kits up to 6m are available but must be requested at time of ordering. All kits include fittings.

** SurgeWave End Caps without Eyes and Twist End Stops are supplied for SurgeWave kits

^For SurgeWave Kits the gliders are replaced with Ocular SurgeWave Roller Gliders-on-a-string – see p176-177 to calculate the number of SurgeWave Gliders required.

KG MEDIUM HEAVY	This curtain track is suitable for medium-to-heavy weight curtains	→	Suitable for straight runs ONLY		Kits/components are delivered in transport packaging		Available in contract components for large jobs		Available in kit form for simple ordering		Tracks available made-to-measure
------------------------------	--	---	---------------------------------	--	--	--	---	--	---	--	----------------------------------

DISCLAIMER: Whilst every effort has been made to ensure colour accuracy, due to the limitations of colour printing, please refer to product samples for colour matching. Product dimensions are for guidance only and may differ – please confirm details at time of ordering.

Ocular Track – Accessories

Brackets



Ocular Curve Wall Bracket 7cm

<input type="checkbox"/> Polar	Code: 16OCB7SCP
<input type="checkbox"/> Dune	Code: 16OCB7SCD
<input type="checkbox"/> Mist	Code: 16OCB7SCM
<input type="checkbox"/> Storm	Code: 16OCB7SCS
<input type="checkbox"/> Noir	Code: 16OCB7SCN
Packed: 1	Min Qty: 1



Ocular Curve Wall Bracket 12cm

<input type="checkbox"/> Polar	Code: 16OCB2LCP
<input type="checkbox"/> Dune	Code: 16OCB2LCD
<input type="checkbox"/> Mist	Code: 16OCB2LCM
<input type="checkbox"/> Storm	Code: 16OCB2LCS
<input type="checkbox"/> Noir	Code: 16OCB2LCN
Packed: 1	Min Qty: 1

S 80mm



Ocular Straight Wall Bracket 9cm

<input type="checkbox"/> Polar	Code: 16OCB9SSP
<input type="checkbox"/> Dune	Code: 16OCB9SSD
<input type="checkbox"/> Mist	Code: 16OCB9SSM
<input type="checkbox"/> Storm	Code: 16OCB9SSS
<input type="checkbox"/> Noir	Code: 16OCB9SSN
Packed: 1	Min Qty: 1

S 80mm



Ocular Straight Wall Bracket 11cm

<input type="checkbox"/> Polar	Code: 16OCB1LSP
<input type="checkbox"/> Dune	Code: 16OCB1LSD
<input type="checkbox"/> Mist	Code: 16OCB1LSM
<input type="checkbox"/> Storm	Code: 16OCB1LSS
<input type="checkbox"/> Noir	Code: 16OCB1LSN
Packed: 1	Min Qty: 1

S 80mm



Ocular Ceiling Fix Bracket with clip-on cover

<input type="checkbox"/> Polar	Code: 16OCBCCP
<input type="checkbox"/> Dune	Code: 16OCBCCD
<input type="checkbox"/> Mist	Code: 16OCBCCM
<input type="checkbox"/> Storm	Code: 16OCBCCS
<input type="checkbox"/> Noir	Code: 16OCBCCN
Packed: 1	Min Qty: 1

End Caps & End Stoppers



Ocular End Cap with Eye

<input type="checkbox"/> Polar	Code: 16OCECEP
<input type="checkbox"/> Dune	Code: 16OCECED
<input type="checkbox"/> Mist	Code: 16OCECEM
<input type="checkbox"/> Storm	Code: 16OCECES
<input type="checkbox"/> Noir	Code: 16OCECEN
Packed: 1	Min Qty: 1



Ocular SurgeWave End Cap*

<input type="checkbox"/> Polar	Code: 16OCECCP
<input type="checkbox"/> Dune	Code: 16OCECCD
<input type="checkbox"/> Mist	Code: 16OCECCM
<input type="checkbox"/> Storm	Code: 16OCECCS
<input type="checkbox"/> Noir	Code: 16OCECCN
Packed: 1	Min Qty: 1

*These End Caps also require additional 6mm Large End Stopper Twist Fit for SurgeWave to work



Large Twist Fit End Stop for 6mm Channel

<input type="checkbox"/> White	Code: 16HO744W
<input type="checkbox"/> Grey	Code: 16HO744T
<input type="checkbox"/> Black	Code: 16HO744K
Packed: 100	Min Qty: 100

Joiners



Ocular Profile Connector Kit

<input type="checkbox"/> Silver	Code: 16OCJOIN
Packed: 1	Min Qty: 1

Gliders



Ocular Roller Gliders

<input type="checkbox"/> Polar	Code: 16OCGLPRSP
<input type="checkbox"/> Dune	Code: 16OCGLPRSD
<input type="checkbox"/> Storm	Code: 16OCGLPRSS
<input type="checkbox"/> Noir	Code: 16OCGLPRSN
Packed: 75	Min Qty: 1

SurgeWave® System Gliders & Accessories



Ocular SurgeWave Roller Gliders-on-a-String

<input type="checkbox"/> Polar	Spacing: 80mm	Code: 16OCGLPR8P
Packed: 40m Roll	Min Qty: 1m	



SurgeWave® Click-In End Lock 6mm Channel

<input type="checkbox"/> Clear	Code: 16SUESCW
Packed: 100	Min Qty: 100

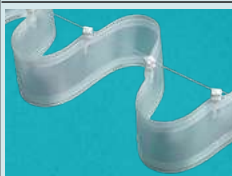

SurgeWave® System Curtain Tape

With 60mm & 80mm Spacing Guides

<input type="checkbox"/> White	Packed: 50m	Code: 51TOWA3R
<input type="checkbox"/> White	Packed: 100m	Code: 51TOWA3CR
<input type="checkbox"/> Black	Packed: 50m	Code: 51TOWAK3R
Min Qty: 100m		



Iron-on SurgeWave® System Curtain Tape

<input type="checkbox"/> White	Packed: 50m	Code: 51TOWIA3R
Min Qty: 100m		



Friction Gliders for SurgeWave® System

<input type="checkbox"/> White	Packed: 10	Code: 16HSFGDW
<input type="checkbox"/> White	Packed: 100	Code: 16HSFGCW
<input type="checkbox"/> Grey	Packed: 10	Code: 16HSFGDT
<input type="checkbox"/> Grey	Packed: 100	Code: 16HSFGCT
<input type="checkbox"/> Black	Packed: 10	Code: 16HSFGDK
<input type="checkbox"/> Black	Packed: 100	Code: 16HSFGCK

Helps prevent curtain spring-back



Neat Pleat Guide for SurgeWave® System

<input type="checkbox"/> White	Code: 16SURNP-
Packed: 10	Min Qty: 10

For more details on how the SurgeWave® System works please see pages 165–180 in this Catalogue



Ocular Samples & POS



Ocular Track Colour Stick

Includes all 5 Track colour samples	
Code: 80OCCOLSTICK	Packed: 1



Ocular Track Sample

40cm with Brackets

Code: 80OCSAMPTRK	Packed: 1
-------------------	------------------



Ocular Track POS Sample Box

Includes all 5 Track colour samples and a selection of brackets in variety of colours.	
Code: 80OCDISPBOX	Packed: 1

DISCLAIMER: Whilst every effort has been made to ensure colour accuracy, due to the limitations of colour printing, please refer to product samples for colour matching. Product dimensions are for guidance only and may differ – please confirm details at time of ordering.

Ocular LIT – LED Kit Upgrades



Ocular LIT Upgrade Kit Components

Components	Track Kit Sizes							
	1.00m (3'3")	1.50m (4'11")	2.00m (6'7")	2.50m (8'2")	3.00m (9'10")	4.00m (13'1")	5.00m (16'5")	6.00m (19'8")
Driver	1 x 30W	1 x 30W	1 x 30W	1 x 30W	1 x 75W	1 x 75W	1 x 75W	1 x 75W
Switch + Plug								
LED Strip	1.00m	1.50m	2.00m	2.50m	3.00m	4.00m	5.00m	6.00m
Snap-on Adapter								
Ocular LIT Upgrade	16OCLUP100_	16OCLUP150_	16OCLUP200_	16OCLUP250_	16OCLUP300_	16OCLUP400_	16OCLUP500_	16OCLUP600_
Packed: 1 px	Min Qty: 1							

Ocular LIT – LED Components

Ocular Lit



Ocular Lit LED Strip

Chip on board design

Code: 16OCLEDS

Packed: 50m Roll Min Qty: 1m



Ocular Lit LED Driver

24V Constant Voltage

30W for 1–3m length Code: 16OCLD30W

75W for 3–6m length Code: 16OCLD75W

Packed: 1 Min Qty: 1



Ocular Lit Solderless Connector

Tape to Wire for 8mm LED Tape

Code: 16OCCTW8

Packed: Pack of 6 Min Qty: 1



Ocular Lit Mains Switch

3m Cable Flex with Switch and Plug

Code: 16OCCFSP3

Packed: 1 Min Qty: 1



DISCLAIMER: Whilst every effort has been made to ensure colour accuracy, due to the limitations of colour printing, please refer to product samples for colour matching. Product dimensions are for guidance only and may differ – please confirm details at time of ordering.

OCULAR IS
NOW AVAILABLE
WITH LED LIGHTS

Lights off

Lights on!



DISCLAIMER: Whilst every effort has been made to ensure colour accuracy, due to the limitations of colour printing, please refer to product samples for colour matching. Product dimensions are for guidance only and may differ – please confirm details at time of ordering.

METAL CURTAIN TRACKS

Glide-Aside® Motorised Track

Battery Powered Motor



Intelligent motorised tracks for optimum ease of use, Renaissance Glide-Aside® Motorised Tracks are strong, competitively priced and available for simple installation of straight track.

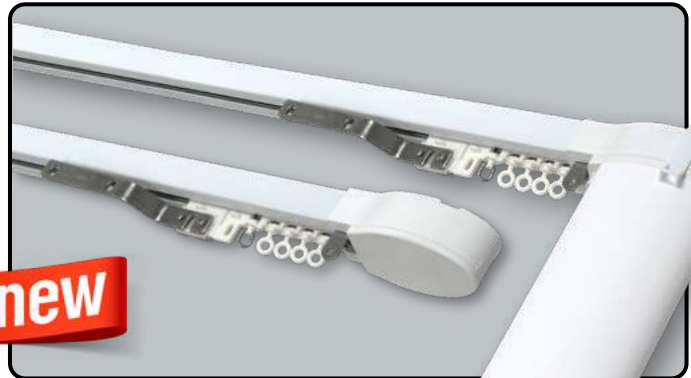

Glide-Aside® Motorised Track
Aluminium Profile 6mm Channel
Size: 6m (19'8") White
Code: 16GA600W
Packed: 10 Lengths Min Qty: 10

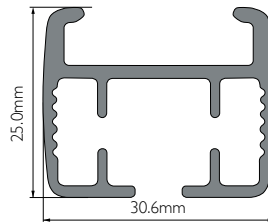

Colour finish available:
WHITE
RAL 9016

All Glide-Aside Kits include a Single Channel Dual Remote as standard. An optional 15-Channel LCD Remote is available as an extra. Each Glide-Aside Track requires a separate mains supply.



KEY FEATURES INCLUDE:

- ✓ Automatic Curtain Tug Start
- ✓ Steel wire strengthened drive belt
- ✓ Smooth-running large Roller Gliders
- ✓ Simple-to-programme limit settings
- ✓ Single side-draw or centre opening option



Glide-Aside® can be set for single side draw or centre opening curtains



Glide-Aside® works at a tug of the curtain

Glide-Aside® Battery Powered Kits Components

NOTE: Kits include a Handheld Single Channel Dual Remote. A 15-Channel LCD Remote is available as an optional extra.

Components	Track Kit Sizes											
	1.00m (3'3")	1.50m (4'11")	2.00m (6'7")	2.50m (8'2")	3.00m (9'10")	3.50m (11'6")	4.00m (13'1")	4.50m (14'9")	5.00m (16'5")	5.50m (18'1")	6.00m (19'8")	
Ceiling Brackets†	3	4	5	6	7	8	9	9	10	10	10	
Roller Gliders^	10	16	20	26	30	36	40	46	50	56	60	
Battery Roller	16GABR100W	16GABR150W	16GABR200W	16GABR250W	16GABR300W	16GABR350W	16GABR400W	16GABR450W	16GABR500W	16GABR550W	16GABR600W	
Battery Surge 80	16GAB8100W	16GAB8150W	16GAB8200W	16GAB8250W	16GAB8300W	16GAB8350W	16GAB8400W	16GAB8450W	16GAB8500W	16GAB8550W	16GAB8600W	
Battery Surge 60	16GAB6100W	16GAB6150W	16GAB6200W	16GAB6250W	16GAB6300W	16GAB6350W	16GAB6400W	16GAB6450W	16GAB6500W	16GAB6550W	16GAB6600W	

Packed: 1 px / Outer 5 Min Qty: 1

All kits include fittings and instructions.

† For Wall Fix please add additional L-Extension Brackets of your choice to the Kit order.

^ For SurgeWave Kits the gliders are replaced with SurgeWave Roller Gliders-on-a-string – see p176-177 to calculate the no. of SurgeWave Gliders required.



This curtain track is suitable for medium-to-heavy weight curtains



Suitable for straight runs ONLY



Kits/components are delivered in transport packaging



Available in contract components for large jobs



Available in kit form for simple ordering



Tracks available made-to-measure

DISCLAIMER: Whilst every effort has been made to ensure colour accuracy, due to the limitations of colour printing, please refer to product samples for colour matching. Product dimensions are for guidance only and may differ – please confirm details at time of ordering.



Glide-Aside® Motorised Track

240v
WIRED

100kg
MAX

240v Mains Powered Motor

Intelligent motorised tracks for optimum ease of use, Renaissance Glide-Aside® Motorised Tracks are strong, competitively priced and available for simple installation of straight track.

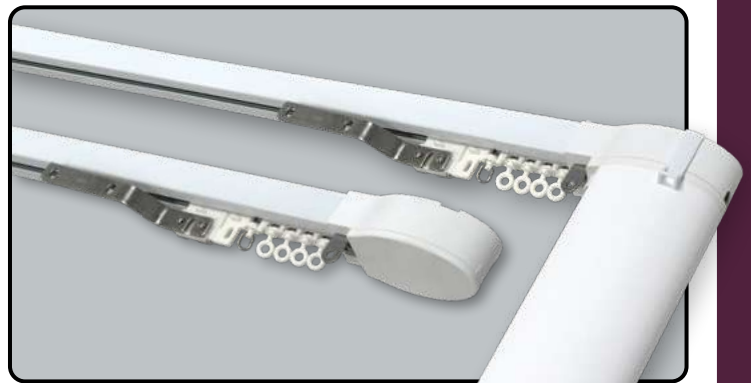

Glide-Aside® Motorised Track
Aluminium Profile 6mm Channel

Size: 6m (19'8") White

Code: 16GA600W

Packed: 10 Lengths Min Qty: 10

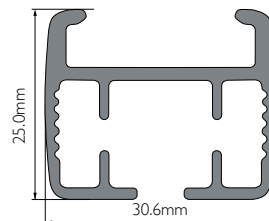

5-YEAR MOTOR
GUARANTEE
BUS Compatible.

Colour finish available:

WHITE
RAL 9016



All Glide-Aside Kits include a Single Channel Dual Remote as standard. An optional 15-Channel LCD Remote is available as an extra. Each Glide-Aside Track requires a separate mains supply.

KEY FEATURES INCLUDE:

- ✓ Automatic Curtain Tug Start
- ✓ Steel wire strengthened drive belt
- ✓ Smooth-running large Roller Gliders
- ✓ Simple-to-programme limit settings
- ✓ Single side-draw or centre opening option



Glide-Aside® can be set for single side draw or centre opening curtains



Glide-Aside® works at a tug of the curtain

Glide-Aside® 240v Mains Powered Kits Components

NOTE: Kits include a Handheld Single Channel Dual Remote. A 15-Channel LCD Remote is available as an optional extra.

Components	Track Kit Sizes											
	1.00m (3'3")	1.50m (4'11")	2.00m (6'7")	2.50m (8'2")	3.00m (9'10")	3.50m (11'6")	4.00m (13'1")	4.50m (14'9")	5.00m (16'5")	5.50m (18'1")	6.00m (19'8")	
Ceiling Brackets†	3	4	5	6	7	8	9	9	10	10	10	
Roller Gliders^	10	16	20	26	30	36	40	46	50	56	60	
Mains Roller	16GAWR100W	16GAWR150W	16GAWR200W	16GAWR250W	16GAWR300W	16GAWR350W	16GAWR400W	16GAWR450W	16GAWR500W	16GAWR550W	16GAWR600W	
Mains Surge 80	16GAW8100W	16GAW8150W	16GAW8200W	16GAW8250W	16GAW8300W	16GAW8350W	16GAW8400W	16GAW8450W	16GAW8500W	16GAW8550W	16GAW8600W	
Mains Surge 60	16GAW6100W	16GAW6150W	16GAW6200W	16GAW6250W	16GAW6300W	16GAW6350W	16GAW6400W	16GAW6450W	16GAW6500W	16GAW6550W	16GAW6600W	

Packed: 1 px / Outer 5 Min Qty: 1

All kits include fittings and instructions.

† For Wall Fix please add additional L-Extension Brackets of your choice to the Kit order.

^ For SurgeWave Kits the gliders are replaced with SurgeWave Roller Gliders-on-a-string – see p176-177 to calculate the no. of SurgeWave Gliders required.

240v
WIRED

100kg
MAX



This curtain track is suitable for medium-to-heavy weight curtains



Suitable for straight runs ONLY



Kits/components are delivered in transport packaging



Available in contract components for large jobs



Available in kit form for simple ordering



Tracks available made-to-measure

DISCLAIMER: Whilst every effort has been made to ensure colour accuracy, due to the limitations of colour printing, please refer to product samples for colour matching. Product dimensions are for guidance only and may differ – please confirm details at time of ordering.

Glide-Aside® Motorised Curtain Track – Motor Options

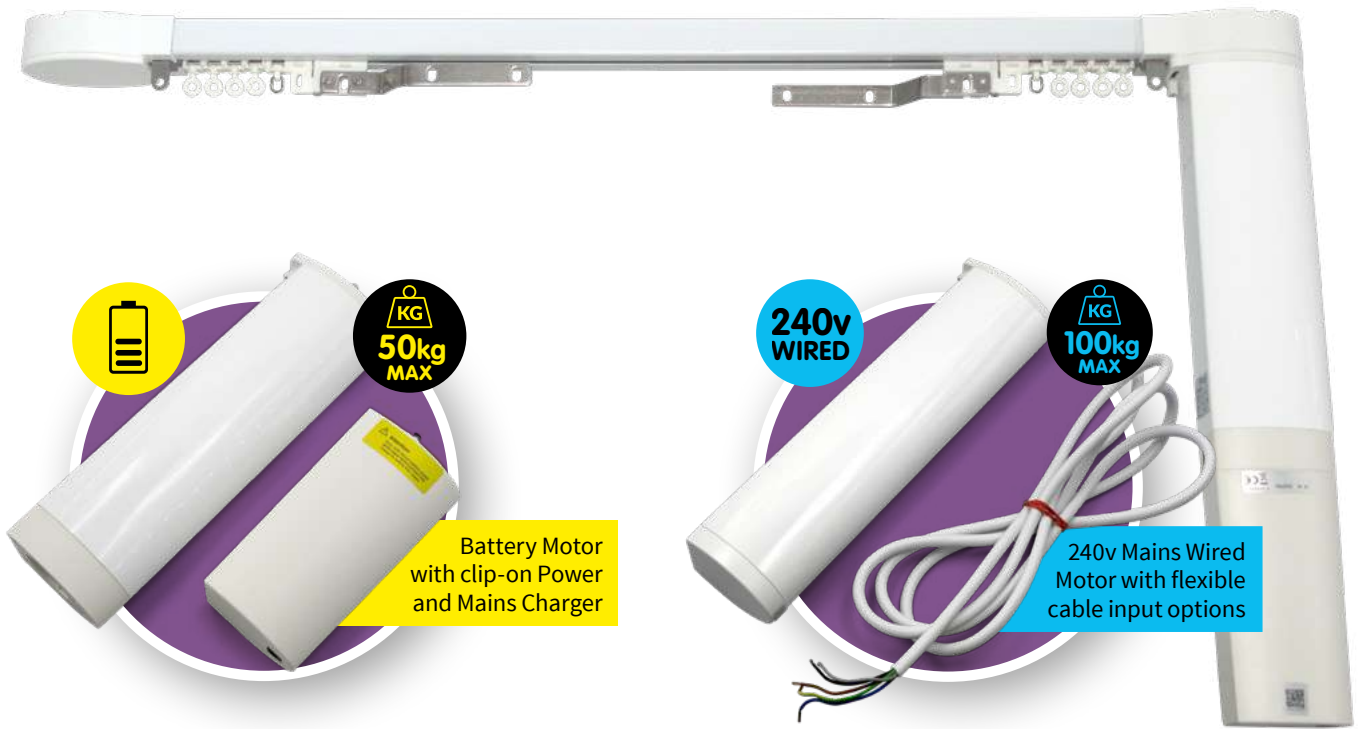

Glide-Aside® Battery Power Components



Glide-Aside Battery Motor With Clip-On Battery

Code: I6GAAMOWB

Packed: 1
Min Qty: 1



Glide-Aside Battery Charger 220v Power Supply Unit

Code: I6GAABCT

Packed: 1 Min Qty: 1

Glide-Aside® Mains Power Components



Glide-Aside 240v Wired Power Motor

Code: I6GAAMOWE

Packed: 1
Min Qty: 1

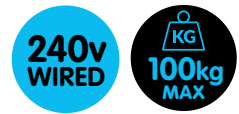

Glide-Aside Wired Power 3-pin Plug + 3 Amp Fuse

Code: I6GAAPLUG

Packed: 1 Min Qty: 1

Glide-Aside® Motorised Curtain Track – Control Options

Glide-Aside® Handheld Remote Transmitters



Glide-Aside Handheld Single Channel Dual Remote

Code: I6GAATI W

Packed: 1 Min Qty: 1

Included in all kits as standard

Includes
wall-mount
magnetic
cradle



Glide-Aside Handheld 15-Channel Dual Remote with LCD Screen

Code: I6GAAT5W

Packed: 1 Min Qty: 1

Includes
wall-mount
magnetic
cradle

Glide-Aside® Remote & Smart Home Accessories



Glide-Aside Wall Mounted Single Channel Remote (Battery Operated)

Code: I6GAAWTK

Packed: 1 Min Qty: 1



Glide-Aside Smart Home Connector Hub

Code: I6GAASHH

Packed: 1 Min Qty: 1

DISCLAIMER: Whilst every effort has been made to ensure colour accuracy, due to the limitations of colour printing, please refer to product samples for colour matching. Product dimensions are for guidance only and may differ – please confirm details at time of ordering.

Glide-Aside® Motorised Curtain Track Components

Glide-Aside® Track Components



Glide-Aside Drive Belt Joiner

Code: I6GAEDRJN
Packed: 10 Min Qty: 10



Glide-Aside End Stopper

Code: I6GAES1S
Packed: 10 Min Qty: 10



Glide-Aside End Stopper Bumper Sponge

Code: I6GAMBS-K
Packed: 10 Min Qty: 10



Glide-Aside Drive Belt

Code: I6GADRV1
Packed: 50m Min Qty: 10m



Glide-Aside Motor End Hook

Code: I6GAMEHW
Packed: 10 Min Qty: 10



Glide-Aside Track Joiner

Code: I6GATRJOIN
Packed: 10 Min Qty: 1

Glide-Aside Track Joiner Screws

Code: I6GATRJO SC



Glide-Aside Overlap Arm

Code: I6GAOV1S
Packed: 5 Min Qty: 5



Glide-Aside Motor Drive End

Code: I6GAMD1W
Packed: 5 Min Qty: 5



Glide-Aside Motor Drive End with Cover

Code: I6GAMDCW
Packed: 5 Min Qty: 5



Glide-Aside End Pulley

Code: I6GAEC1W
Packed: 5 Min Qty: 5

Glide-Aside® Gliders



Glide-Aside Large Roller Glider

White Code: I6GAAGLW
Packed: 100 Min Qty: 10

SurgeWave® System Gliders & Accessories



Glide-Aside SurgeWave® System Roller Glider-on-a-String

White Spacing: 60mm Code: I6GA60RGSW
 White Spacing: 80mm Code: I6GA80RGSW
Packed: 40m Roll Min Qty: 1m



SurgeWave® System Curtain Tape

With 60mm & 80mm Spacing Guides

White Packed: 50m Code: 51TOWA3R
 White Packed: 100m Code: 51TOWA3CR
 Black Packed: 50m Code: 51TOWAK3R
Min Qty: 100m



Iron-on SurgeWave® System Curtain Tape

White Packed: 50m Code: 51TOWIA3R
Min Qty: 100m

For more details on how the SurgeWave® System works please see pages 165–180 in this Catalogue



Glide-Aside® Brackets



Ceiling Lever Bracket

White Code: I6GAABCW
Packed: 100 Min Qty: 10

To wall fix just add an L-Extension Bracket to the Ceiling Lever Brackets

L-Extension Brackets can be used with tracks and blinds to increase the projection from the wall to the desired length. Covers are also available for a neat finish. See page 110.



3cm L-Extension Bracket

White Code: I6LB031W
Packed: 10 Min Qty: 10



9cm L-Extension Bracket

White Code: I6LB091W
Packed: 10 Min Qty: 10

S80mm
S60mm



14cm L-Extension Bracket

White Code: I6LB141W
Packed: 10 Min Qty: 10

S80mm
S60mm



L-Extension Bracket Cover

A one-size-fits all solution for any size L-Extension Bracket – simply snap-off to fit to size.

White Code: I6LBCOVW
Packed: 10 Min Qty: 10

How it works: Fixing Options



Ceiling Lever Bracket
Supplied as standard in all
Glide-Aside kits



L-Extension Bracket for Wall Fix
Available in 3, 9 & 14cm sizes.
Please order separately.

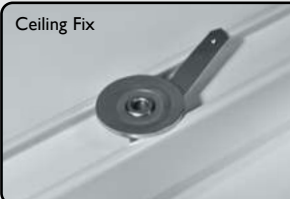

Ceiling Fix



Wall Fix

DISCLAIMER: Whilst every effort has been made to ensure colour accuracy, due to the limitations of colour printing, please refer to product samples for colour matching. Product dimensions are for guidance only and may differ – please confirm details at time of ordering.





Veltrack Profile

Curtain Blackout Solution

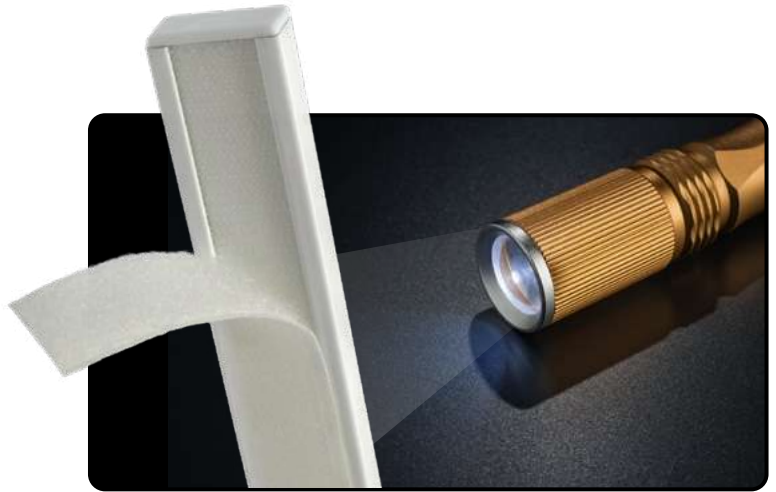
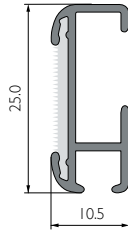
Using Standard Ceiling Fix Brackets to fix Veltrack Profile running vertically either side of a window so curtains can be held flush to the wall to prevent light coming through.

Ideal for curtains using SurgeWave® System to ensure final end pleats fall neat and secure.



Veltrack Blackout Components	
	<p>Veltrack Profile Size: 3m (9'10") <input type="checkbox"/> White Code: I7HV300W Packed: 10 Lengths Min Qty: 10</p> <p>Size: 6m (19'8") <input type="checkbox"/> White Code: I7HV600W Packed: 20 Lengths Min Qty: 20</p>
	<p>End Caps for Veltrack Profile <input type="checkbox"/> White Code: I7HVECCW Packed: 100 Min Qty: 10</p>
	<p>Ceiling Standard Bracket (with Hole) <input type="checkbox"/> White Code: I6HSBHCW Packed: 100 Min Qty: 100</p>
	<p>20mm Loop Tape Sew-On <input type="checkbox"/> White Code: 53C1SLRW <input checked="" type="checkbox"/> Black Code: 53C1SLRK Packed: 25m Roll</p>

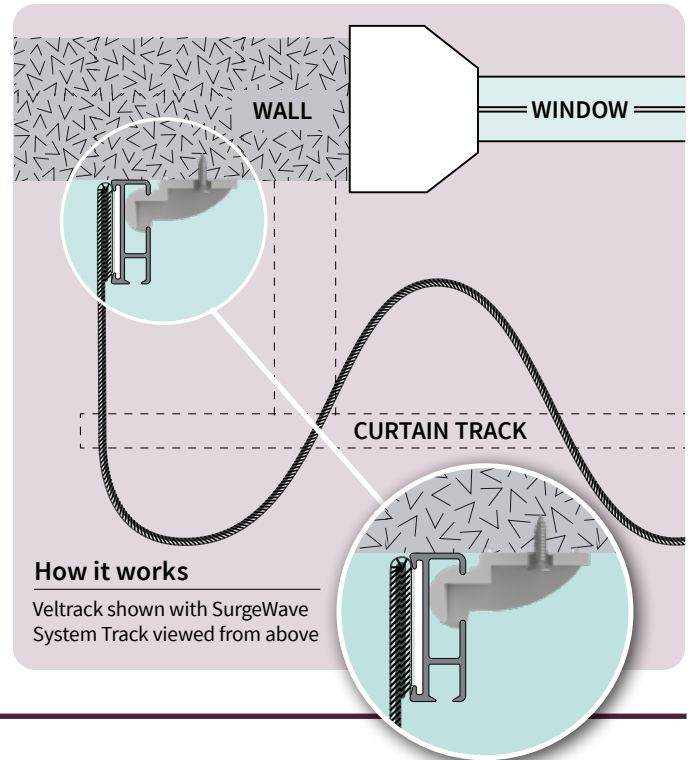



Blackout Profile new

Direct Fix – Pre-Drilled Holes

A direct fix to wall solution for creating a vertical Hook & Loop profile either side of a window so curtains can be held flush to the wall to prevent light coming through.

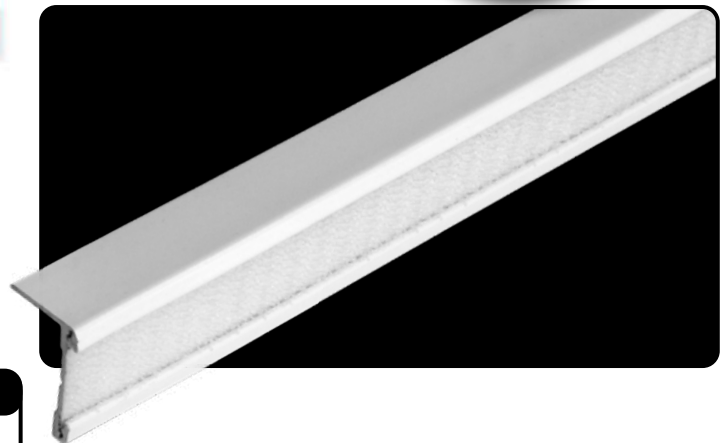
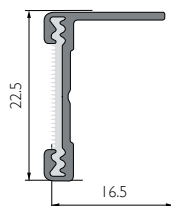
Ideal for curtains using SurgeWave® System to ensure final end pleats fall neat and secure.

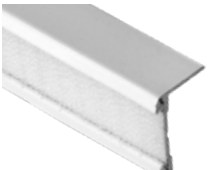

Blackout Profile Components	
	<p>Blackout Profile Pre-drilled Holes Size: 3m (9'10") <input type="checkbox"/> White Code: I7BP300W Packed: 10 Lengths Min Qty: 10</p> <p>Size: 6m (19'8") <input type="checkbox"/> White Code: I7BP600W Packed: 20 Lengths Min Qty: 20</p>
	<p>20mm Loop Tape Sew-On <input type="checkbox"/> White Code: 53C1SLRW <input checked="" type="checkbox"/> Black Code: 53C1SLRK Packed: 25m Roll</p>

DISCLAIMER: Whilst every effort has been made to ensure colour accuracy, due to the limitations of colour printing, please refer to product samples for colour matching. Product dimensions are for guidance only and may differ – please confirm details at time of ordering.

How to install Veltrack

Install your lengths of Veltrack Profile vertically each side of your window frame with Hook & Loop side of the profile facing outside – as shown below.

With the Loop side of the Hook & Loop Tape sewn to the outside edge of your curtains which can now be neatly held in place on the rail, flush to the wall.

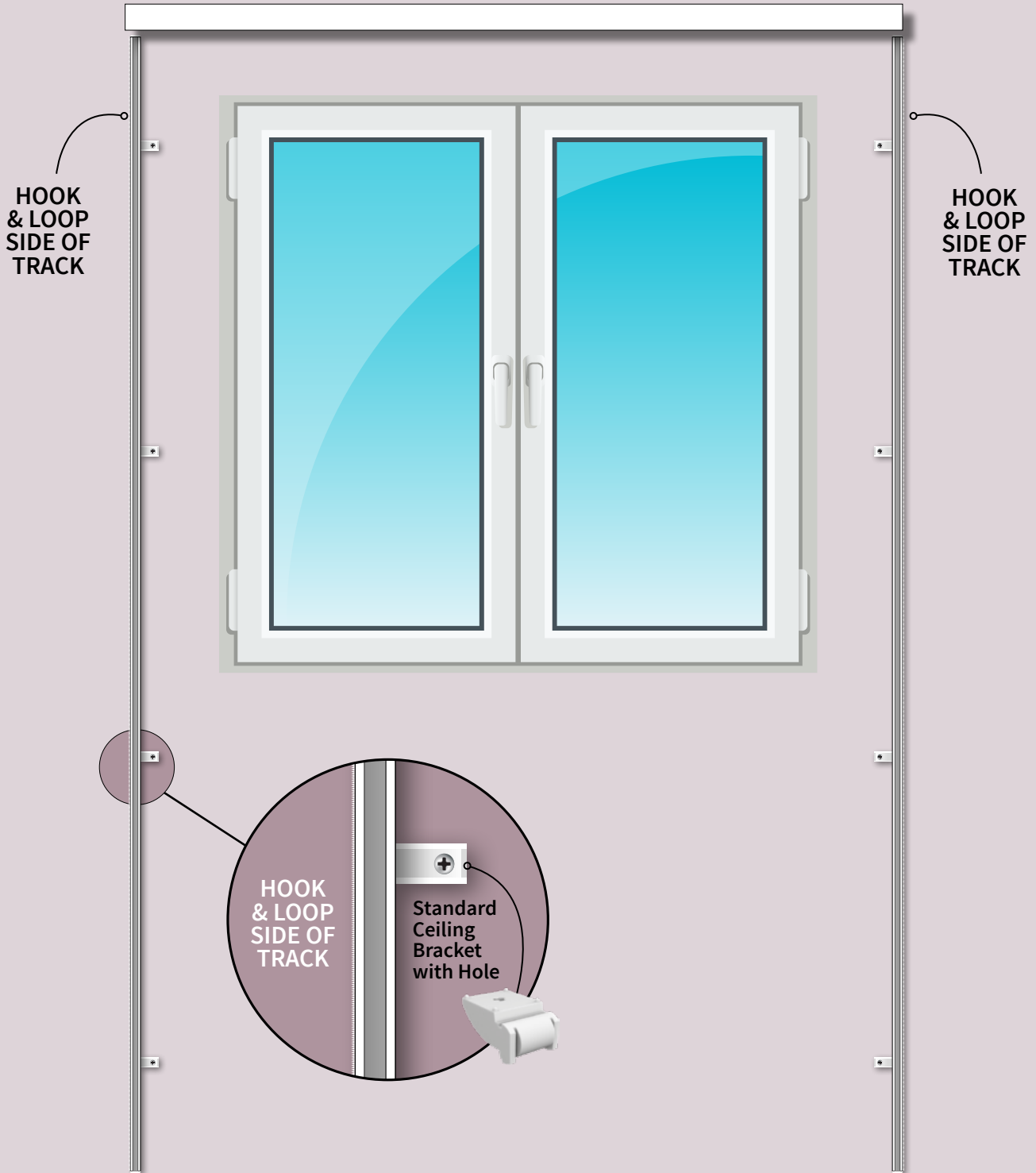

DISCLAIMER: Whilst every effort has been made to ensure colour accuracy, due to the limitations of colour printing, please refer to product samples for colour matching. Product dimensions are for guidance only and may differ – please confirm details at time of ordering.



I-Beam

Aluminium Profile Track

Aluminium I-Beam Track in contract form, suitable for the contractor or retail store. The original versatile curtain track, may be bent for corners or bays.

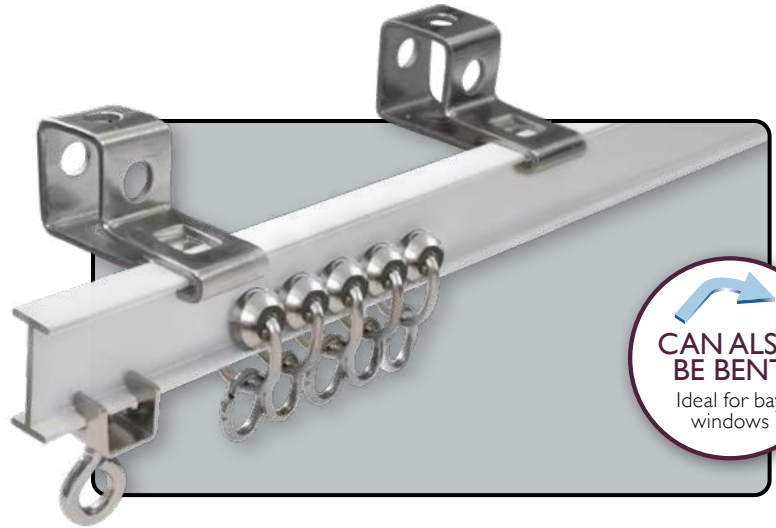

I-Beam Aluminium Profile

Size: 5m (14'0")

Packed: 10 Lengths

White
Min Qty: 10

Code: 20IB500W

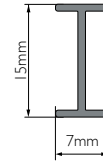

Colour finishes available:

WHITE

I-Beam Aluminium Profile Track Kit Components

Components	Track Kit Sizes									
	1.00m (3'3")	1.50m (4'11")	1.75m (5'8")	2.00m (6'7")	2.25m (7'5")	2.50m (8'2")	2.75m (9'0")	3.00m* (9'10")	4.00m* (13'1")	5.00m* (16'4")
Profile	1 x 1.00m	1 x 1.50m	1 x 1.75m	1 x 2.00m	1 x 2.25m	1 x 2.50m	1 x 2.75m	2 x 1.50m	2 x 2.00m	2 x 2.50m
Brackets	3	3	4	4	5	5	6	8	12	16
Twist End Stops	2	2	2	2	2	2	2	2	2	2
Runners	10	16	18	20	24	26	28	30	40	50
Nylon Runner Kit	20IBUY100W	20IBUY150W	20IBUY175W	20IBUY200W	20IBUY225W	20IBUY250W	20IBUY275W	20IBUY300W	20IBUY400W	20IBUY500W
Nickel Runner Kit	20IBUN100W	20IBUN150W	20IBUN175W	20IBUN200W	20IBUN225W	20IBUN250W	20IBUN275W	20IBUN300W	20IBUN400W	20IBUN500W

Packed: 1 px/Outer 5 Min Qty: 10

* Denotes 2 piece profile. All kits include fittings.



This curtain track is suitable for medium-to-heavy weight curtains

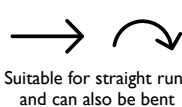

Suitable for straight runs and can also be bent

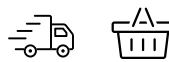

Kits/components are delivered in transport or retail packaging



Available in contract components for large jobs



Available in kit form for simple ordering



Not available made-to-measure

I-Beam Track Components

I-Beam Accessories



Nylon Roller Runners

White

Pre-Packed: 10 px/Outer 10 Code: 20IBNRD-
Contract Packed: Box 100 Code: 20IBNRC-



Nickel Plated Roller Runners

Nickel

Pre-Packed: 10 px/Outer 10 Code: 20IBSRD-
Contract Packed: Box 100 Code: 20IBSRC-



I-Beam Track Bracket Can be top or face fixed

Silver

Pre-Packed: 5 px/Outer 10 Code: 20IBSB5-
Contract Packed: Box 100 Code: 20IBBKC-

I-Beam Accessories



End Stop

Silver

Pre-Packed: 2 px/Outer 10 Code: 20IBSE2-
Contract Packed: Box 100 Code: 20IBESC-



I-Beam Fitting Set for 4m Contract Track

Includes: 12 x Brackets, 40 x Runners, 2 x End Stops

White Nylon Runners Code: 20IF400S

Nickel Plated Runners Code: 20IF400N

Packed: 1 Set

DISCLAIMER: Whilst every effort has been made to ensure colour accuracy, due to the limitations of colour printing, please refer to product samples for colour matching. Product dimensions are for guidance only and may differ – please confirm details at time of ordering.



SURGEWAVE[®] SYSTEM

SURGEWAVE[®] SYSTEM



SurgeWave® System

The SurgeWave® System from Renaissance gives a consistent heading without having to pull any strings and with your curtains open, SurgeWave® stacks back to give a tidy, minimalistic look.

The simple-to-install system produces smooth, consistent waves in your fabric which effortlessly glides along your chosen track.



COMPATIBLE PRODUCT

Look for the SurgeWave® System compatibility logo.

How it Works Curtains open

With curtains open SurgeWave® stacks back to give a tidy, minimalistic look.



ALSO AVAILABLE
SurgeWave®
Neat Pleat Guides

Stacked back from above with Neat Pleat Guides on the last gliders.

How it Works Curtains drawn closed

SurgeWave® gives smooth, consistent waves in your fabric with the curtains drawn closed to a flush finish thanks to the Neat Pleat Guides

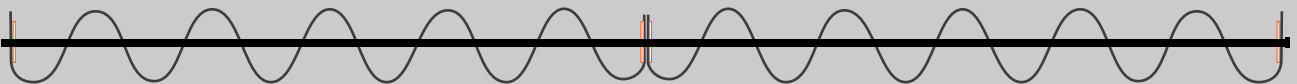

How it Works SurgeWave® Neat Pleat Guides

Neat Pleat Guides clip onto the last 4mm or 6mm SurgeWave® Gliders at each end of your curtains. This ensures the edge of the curtain is folded neatly back to the wall and that your curtains meet with a flush finish when drawn closed.



Neat Pleat Guides
+ Draw Rod

The central hole on the guide can also be used to facilitate a draw rod!

See **Page 192** for Draw Rods

DISCLAIMER: Whilst every effort has been made to ensure colour accuracy, due to the limitations of colour printing, please refer to product samples for colour matching. Product dimensions are for guidance only and may differ – please confirm details at time of ordering.

How it Works SurgeWave® Tape

Fast and accurate curtain hook insertion is guaranteed thanks to the stitched-in universal spacing guides to indicate 60mm spacing on one edge and 80mm spacing on the opposite side.

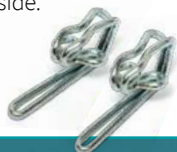

new
SurgeWave®
System Tape is
now available
in Black!

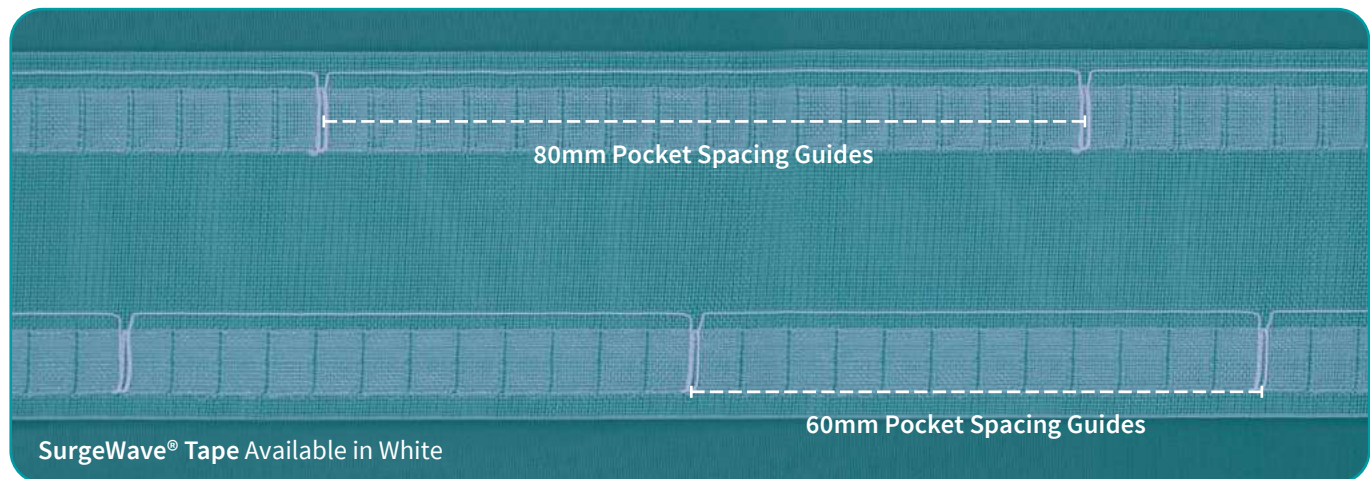

How it Works SurgeWave® Friction Gliders

This ingenious SurgeWave® System device helps to prevent curtain spring-back

Friction gliders simply clip the device over leading SurgeWave® gliders on your uncorded track for the friction to work it's magic!



ALSO AVAILABLE
SurgeWave® System
Friction Gliders

Now available
in 3 colours

DISCLAIMER: Whilst every effort has been made to ensure colour accuracy, due to the limitations of colour printing, please refer to product samples for colour matching. Product dimensions are for guidance only and may differ – please confirm details at time of ordering.

SurgeWave® System

4mm Channel Profile Tracks

Key Features:



IN-STOCK DELIVERY



MADE TO MEASURE



TRACK KITS AVAILABLE



WORKS ON BENDS



Look out for the SurgeWave logos for track compatibility.

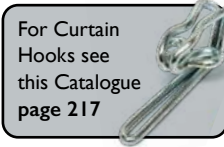

Channel Size	4mm or 6mm versions
Compatibility	Various – see table on Page 178 Works with split stack, single stack, corded and uncorded systems.
Glidors per Metre	60mm spacing – Approx 16 Glidors per Metre 80mm spacing – Approx 12 Glidors per Metre
Curtain Weight	Suitable for Light to Heavy Weight Curtains
Bending	Works with bent track
Features & Tips	<ul style="list-style-type: none"> To get the best appearance ensure that the curtain 'ends' are returned to behind the track. As a guide, work to double fullness. The flow depth can be adjusted by where you position the hooks. No strings to pull up – a crisp tidy finish.

How it works Wall Bracket size for SurgeWave® System

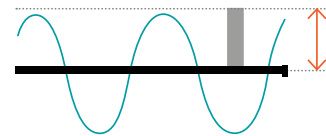

This illustration shows from above how the SurgeWave Tape with curtains drawn will require wall clearance to allow for the pleats to flow without touching the wall.

For the SurgeWave System Tape to operate with appropriate clearance we recommend the following minimum projection from the wall to the centre of the channel of your chosen track:

- 60mm SurgeWave Glidors require a minimum projection of 6cm
- 80mm SurgeWave Glidors require a minimum projection of 8cm

SurgeWave® System Glidors



4mm SurgeWave® Glidors
60mm Spacing Packed: 25m Roll
 White Code: 16HS60GLST
 Black Code: 16HS60GLSX

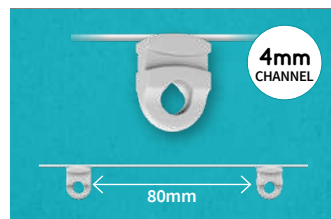

4mm SurgeWave® Glidors
80mm Spacing Packed: 25m Roll
 White Code: 16HS80GLST
 Black Code: 16HS80GLSX



SurgeWave® System Accessories



SurgeWave® System Curtain Tape

With 60mm & 80mm Spacing Guides

- White Packed: 50m Code: 51TOWA3R
 - White Packed: 100m Code: 51TOWA3CR
 - Black Packed: 50m Code: 51TOWAK3R
- Min Qty: 100m



Iron-on SurgeWave® System Curtain Tape

- White Packed: 50m Code: 51TOWIA3R
- Min Qty: 100m



Friction Glidors for SurgeWave® System

NOTE: Not compatible with Ribbon Glidors

- White Packed: 10 Code: 16HSFGDW
- White Packed: 100 Code: 16HSFGCW
- Grey Packed: 10 Code: 16HSFGDT
- Grey Packed: 100 Code: 16HSFGCT
- Black Packed: 10 Code: 16HSFGDK
- Black Packed: 100 Code: 16HSFGCK



Neat Pleat Guide for SurgeWave® System

Clips onto 4mm & 6mm SurgeWave Glidors

- White Code: 16SURNP-
- Packed: 10 Min Qty: 10

DISCLAIMER: Whilst every effort has been made to ensure colour accuracy, due to the limitations of colour printing, please refer to product samples for colour matching. Product dimensions are for guidance only and may differ – please confirm details at time of ordering.



SurgeWave® System 4mm Channel Tracks

SurgeWave® System – 4mm SurgeWave Gliders

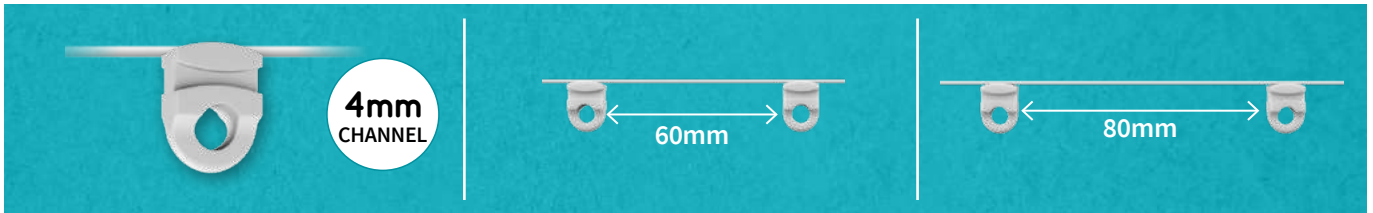

4mm SurgeWave® Gliders-on-a-String

60mm Spacing

- White
- Black

Packed: 25m Roll

- Code: 16HS60GLST
- Code: 16HS60GLSX

80mm Spacing

- White
- Black

Packed: 25m Roll

- Code: 16HS80GLST
- Code: 16HS80GLSX

COMPATIBLE TRACKS

Principal



Optimal

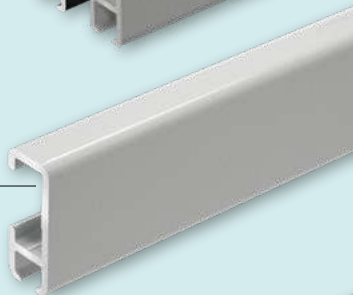

Mini Optimal



Mini U-Section Wall Fix

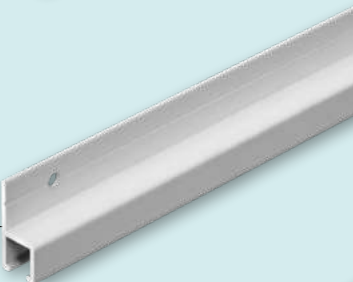

Mini U-Section Top Fix

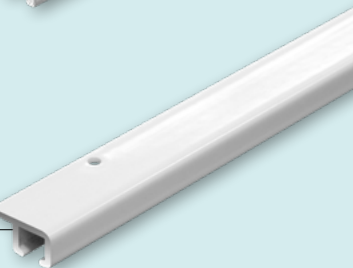

Professional

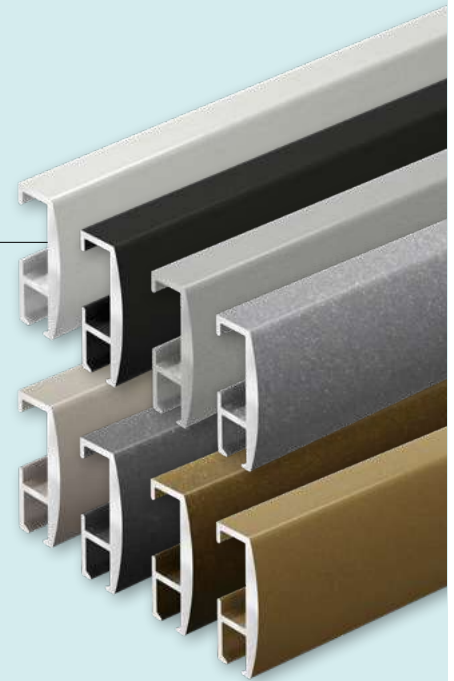

Mini Professional

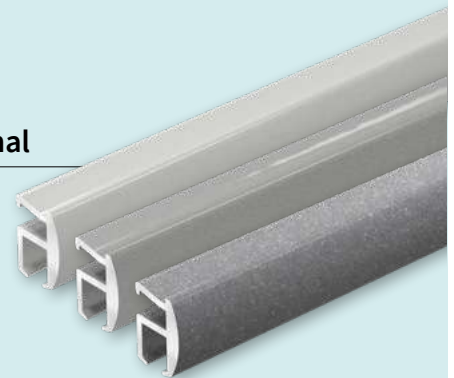

DISCLAIMER: Whilst every effort has been made to ensure colour accuracy, due to the limitations of colour printing, please refer to product samples for colour matching. Product dimensions are for guidance only and may differ – please confirm details at time of ordering.

SurgeWave® System

6mm Channel Profile Tracks

Key Features:



IN-STOCK DELIVERY

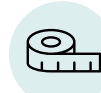

MADE TO MEASURE



TRACK KITS AVAILABLE



WORKS ON BENDS



Look out for the SurgeWave logos for track compatibility.

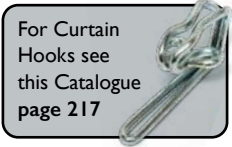

Channel Size	4mm or 6mm versions
Compatibility	Various – see tables on p179–180 Works with split stack, single stack, corded and uncorded systems.
Glidens per Metre	60mm spacing – Approx 16 Glidens per Metre 80mm spacing – Approx 12 Glidens per Metre
Curtain Weight	Suitable for Light to Heavy Weight Curtains
Bending	Works with bent track
Features & Tips	<ul style="list-style-type: none"> To get the best appearance ensure that the curtain 'ends' are returned to behind the track. As a guide, work to double fullness. The flow depth can be adjusted by where you position the hooks. No strings to pull up – a crisp tidy finish.

How it works Wall Bracket size for SurgeWave® System

This illustration shows from above how the SurgeWave Tape with curtains drawn will require wall clearance to allow for the pleats to flow without touching the wall.

For the SurgeWave System Tape to operate with appropriate clearance we recommend the following minimum projection from the wall to the centre of the channel of your chosen track:

60mm SurgeWave Gliders require a minimum projection of 6cm
80mm SurgeWave Gliders require a minimum projection of 8cm

SURGEWAVE® SYSTEM

SurgeWave® System Gliders

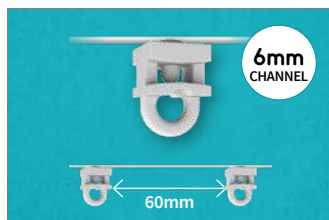

6mm SurgeWave® Gliders-on-a-String
 60mm Spacing Packed: 25m Roll
 ○ White Code: 16HH60GLST
 ● Black Code: 16HH60GLSK

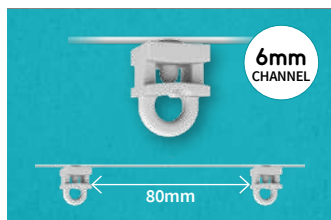

6mm SurgeWave® Gliders-on-a-String
 80mm Spacing Packed: 25m Roll
 ○ White Code: 16HH80GLST
 ● Black Code: 16HH80GLSK



6mm SurgeWave® Ribbon Gliders
 60mm Spacing Packed: 25m Roll
 ○ White Code: 16SW6RG60W
 ● Black Code: 16SW6RG60K
 ● Grey Code: 16SW6RG60G



6mm SurgeWave® Ribbon Gliders
 80mm Spacing Packed: 25m Roll
 ○ White Code: 16SW6RG80W
 ● Black Code: 16SW6RG80K
 ● Grey Code: 16SW6RG80G



6mm Roller SurgeWave® Gliders (Wide)
 60mm Spacing Packed: 30m Roll
 ○ White Code: 16GL7SR60W

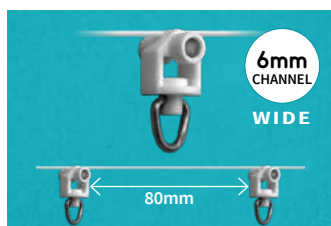

6mm Roller SurgeWave® Gliders (Wide)
 80mm Spacing Packed: 40m Roll
 ○ White Code: 16GL7SR80W

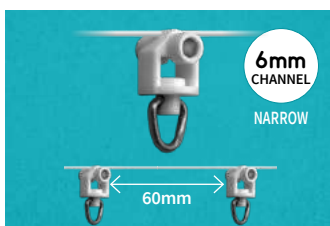

6mm Roller SurgeWave® Gliders (Narrow)
 60mm Spacing Packed: 30m Roll
 ○ White Code: 16GL6SR60W

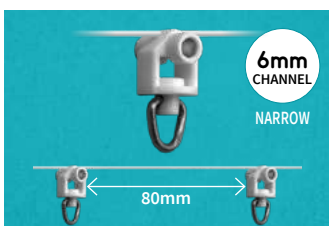

6mm Roller SurgeWave® Gliders (Narrow)
 80mm Spacing Packed: 40m Roll
 ○ White Code: 16GL6SR80W

DISCLAIMER: Whilst every effort has been made to ensure colour accuracy, due to the limitations of colour printing, please refer to product samples for colour matching. Product dimensions are for guidance only and may differ – please confirm details at time of ordering.

SurgeWave® System 6mm Channel Tracks

SurgeWave® System – 6mm SurgeWave® Gliders

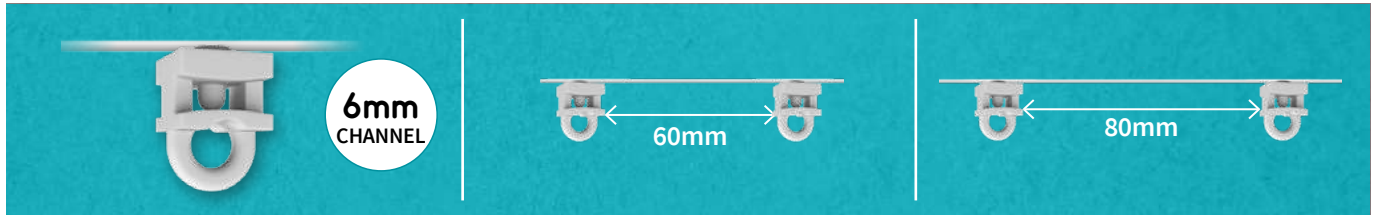

6mm SurgeWave® Gliders-on-a-String

60mm Spacing
 ○ White
 ● Black

Packed: 25m Roll
 Code: 16HH60GLST
 Code: 16HH60GLSX

80mm Spacing
 ○ White
 ● Black

Packed: 25m Roll
 Code: 16HH80GLST
 Code: 16HH80GLSK

COMPATIBLE TRACKS:

Silent Glide

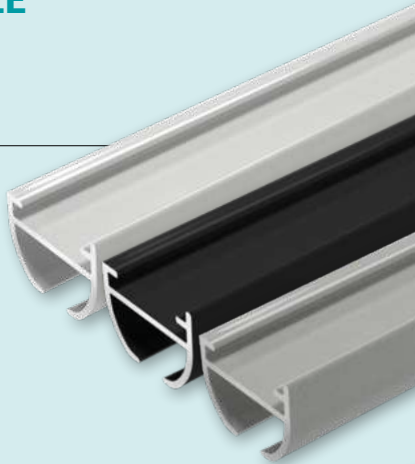

Heavy Duty H-Section

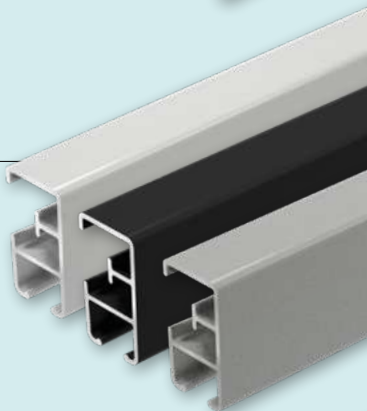

W-Section

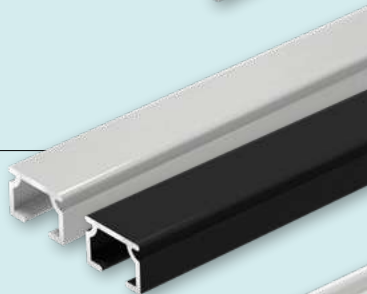

Heavy Duty Corded

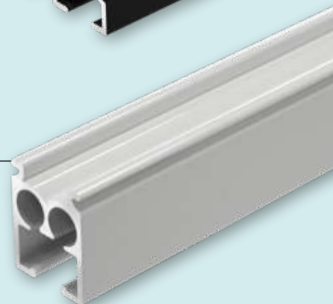

Motiva Round Corded/Uncorded



Motiva Flat

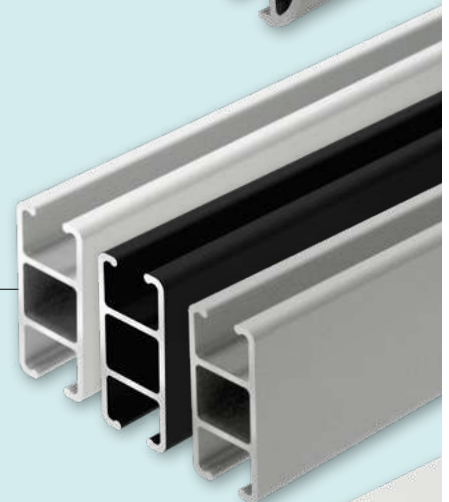

L-Section

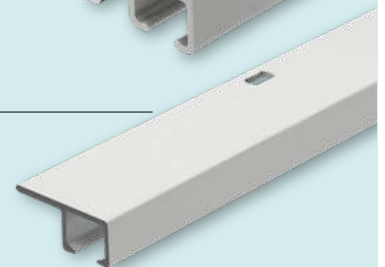

DISCLAIMER: Whilst every effort has been made to ensure colour accuracy, due to the limitations of colour printing, please refer to product samples for colour matching. Product dimensions are for guidance only and may differ – please confirm details at time of ordering.

SurgeWave® System 6mm Channel Tracks

SurgeWave® System – 6mm Ribbon SurgeWave® Gliders

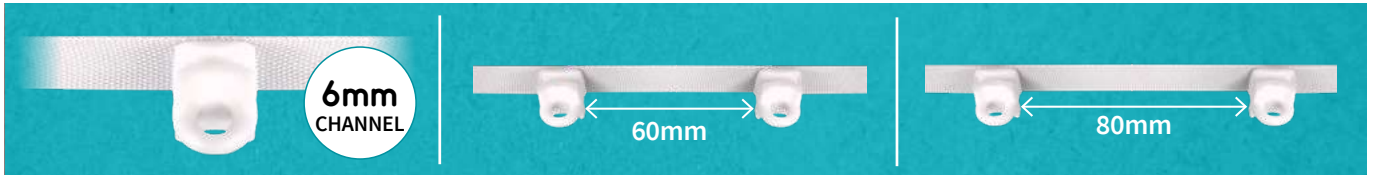

6mm SurgeWave® Ribbon Gliders



60mm Spacing

- White
- Black
- Grey

Packed: 100m Roll

- Code: 16SW6RG60W
- Code: 16SW6RG60K
- Code: 16SW6RG60G

80mm Spacing

- White
- Black
- Grey

Packed: 100m Roll

- Code: 16SW6RG80W
- Code: 16SW6RG80K
- Code: 16SW6RG80G

COMPATIBLE TRACKS:

Silent Glide

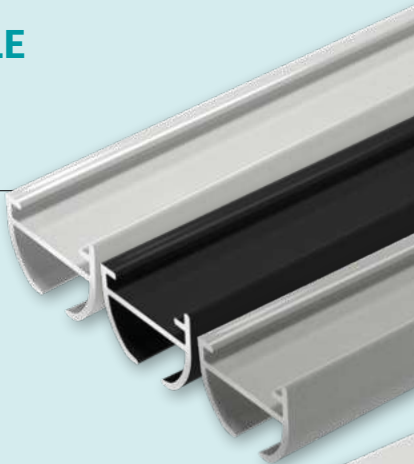

Heavy Duty H-Section

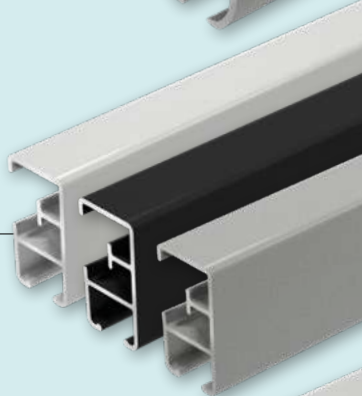

W-Section

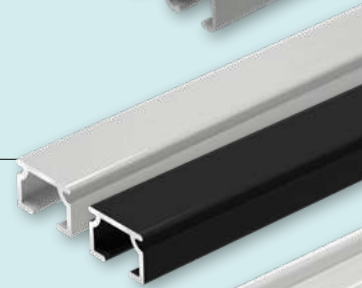

Heavy Duty Corded

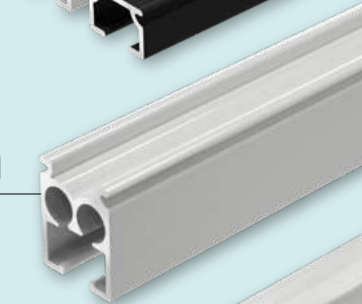

Recess M-Section

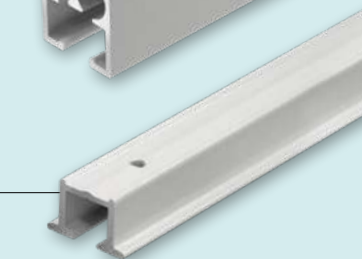

Motiva Round Corded/Uncorded



Motiva Flat

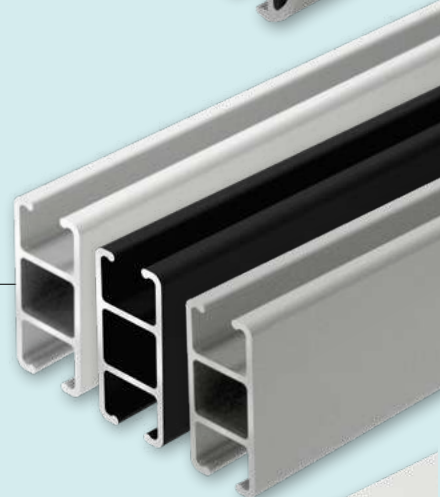

L-Section

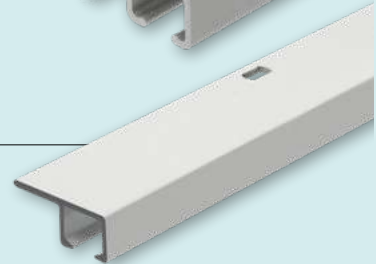

DISCLAIMER: Whilst every effort has been made to ensure colour accuracy, due to the limitations of colour printing, please refer to product samples for colour matching. Product dimensions are for guidance only and may differ – please confirm details at time of ordering.

SurgeWave® System 6mm Channel Tracks

SurgeWave® System – 6mm Roller SurgeWave® Gliders

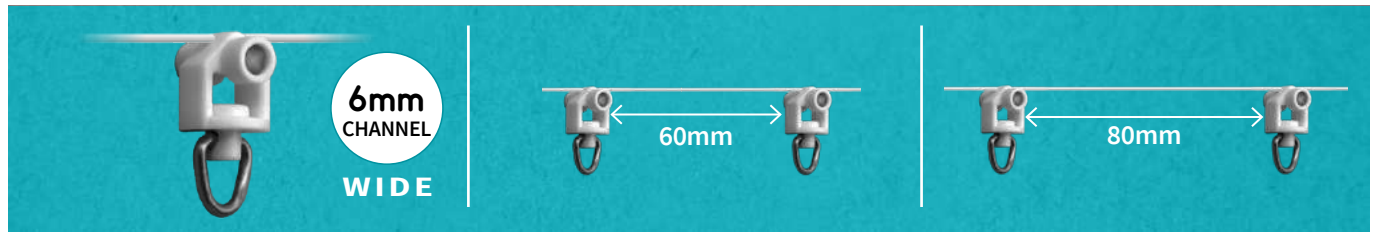

6mm Roller SurgeWave®
Gliders-on-a-String Wide

60mm Spacing
○ White

Packed: 30m Roll
Code: 16GL7SR60W

80mm Spacing
○ White

Packed: 40m Roll
Code: 16GL7SR80W

COMPATIBLE TRACKS:

Silent Glide

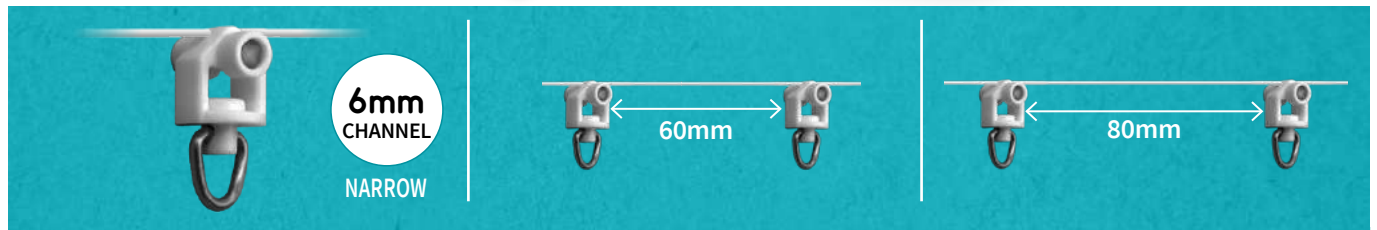
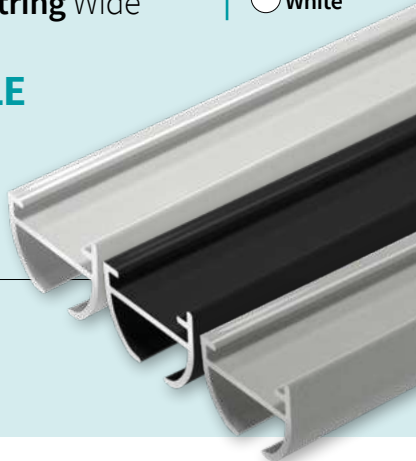

6mm Roller SurgeWave®
Gliders-on-a-String Narrow

60mm Spacing
○ White

Packed: 30m Roll
Code: 16GL6SR60W

80mm Spacing
○ White

Packed: 40m Roll
Code: 16GL6SR80W

COMPATIBLE TRACKS:

Heavy Duty
H-Section



L-Section

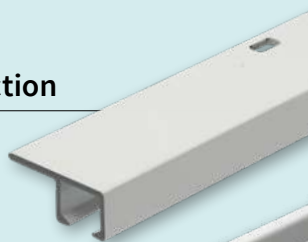

Heavy Duty
Corded

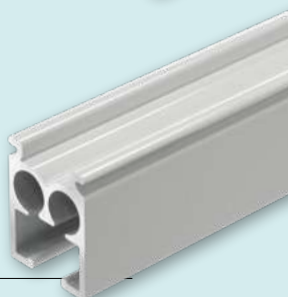

Motiva
Flat



Motiva Round
Corded/Uncorded



DISCLAIMER: Whilst every effort has been made to ensure colour accuracy, due to the limitations of colour printing, please refer to product samples for colour matching. Product dimensions are for guidance only and may differ – please confirm details at time of ordering.



SurgeWave® System – All Gliders & Accessories

SurgeWave® System – 4mm SurgeWave® Gliders

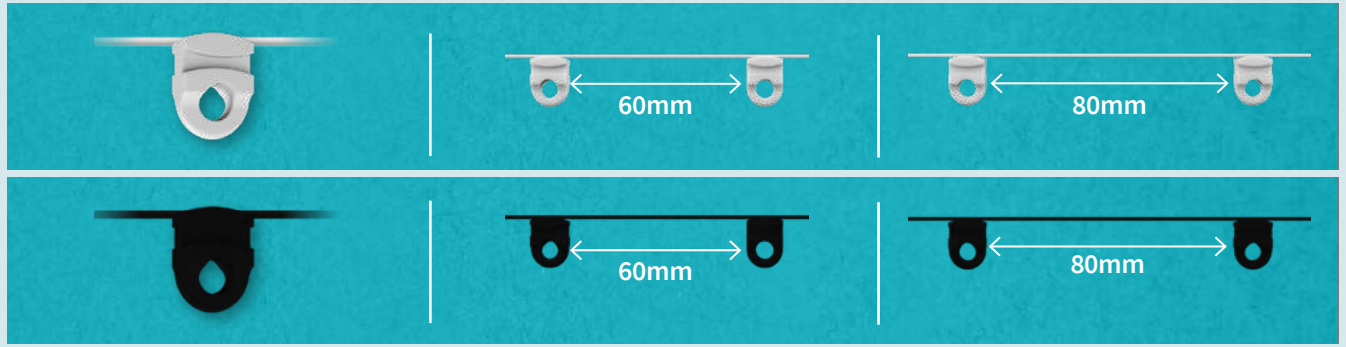

**4mm SurgeWave®
Gliders on-a-String**

60mm Spacing

○ White

● Black

Packed: 25m Roll

Code: 16HS60GLST

Code: 16HS60GLSX

80mm Spacing

○ White

● Black

Packed: 25m Roll

Code: 16HS80GLST

Code: 16HS80GLSX

SurgeWave® System – 6mm SurgeWave® Gliders

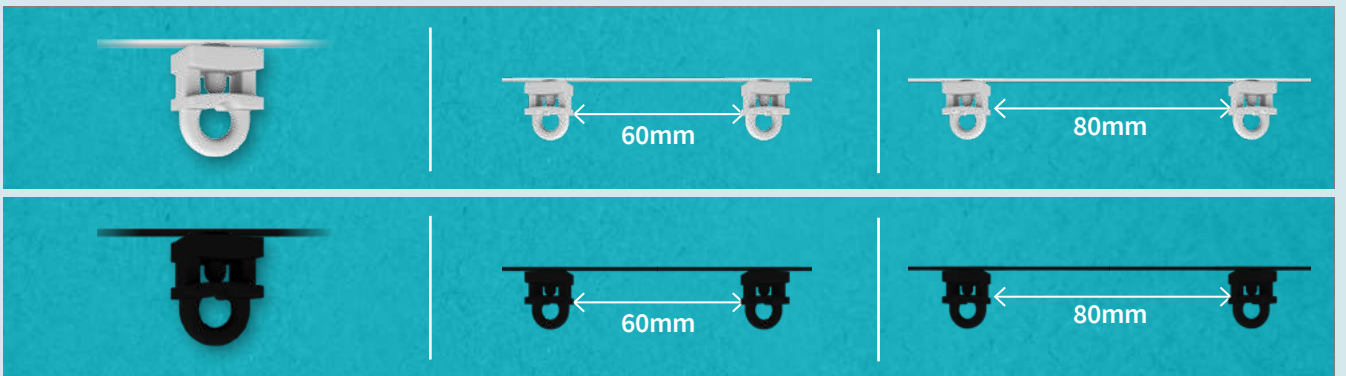

**6mm SurgeWave®
Gliders on-a-String**

60mm Spacing

○ White

● Black

Packed: 25m Roll

Code: 16HH60GLST

Code: 16HH60GLSX

80mm Spacing

○ White

● Black

Packed: 25m Roll

Code: 16HH80GLST

Code: 16HH80GLSX

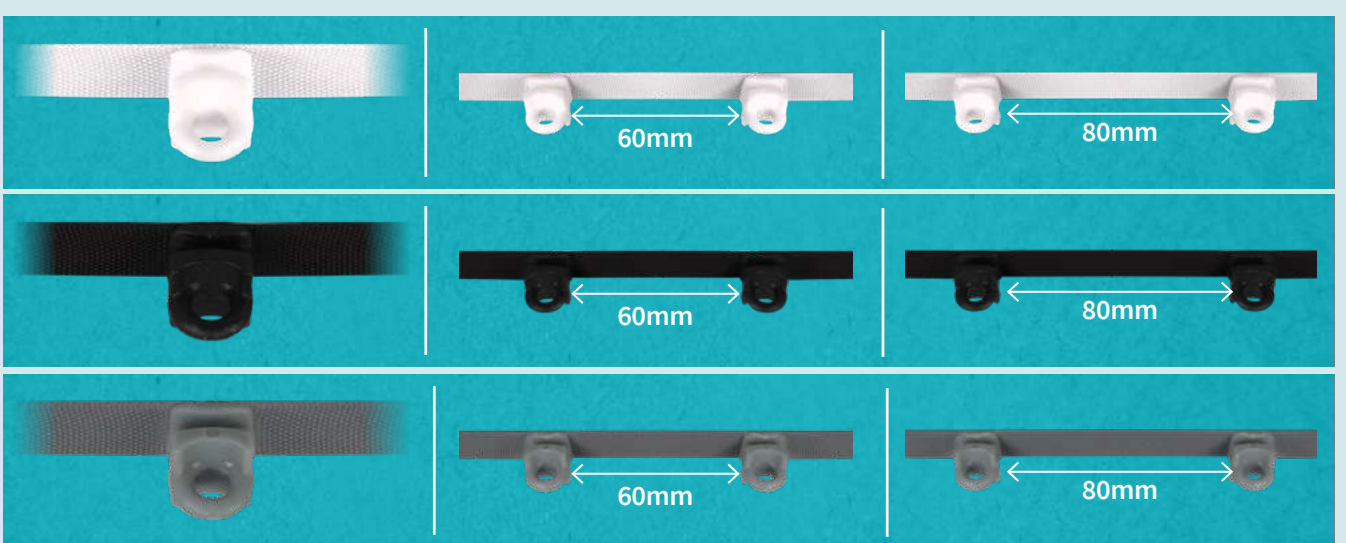

**6mm SurgeWave®
Ribbon Gliders**

new

60mm Spacing

○ White

● Black

● Grey

Packed: 100m Roll

Code: 16SW6RG60W

Code: 16SW6RG60K

Code: 16SW6RG60G

80mm Spacing

○ White

● Black

● Grey

Packed: 100m Roll

Code: 16SW6RG80W

Code: 16SW6RG80K

Code: 16SW6RG80G

DISCLAIMER: Whilst every effort has been made to ensure colour accuracy, due to the limitations of colour printing, please refer to product samples for colour matching. Product dimensions are for guidance only and may differ – please confirm details at time of ordering.

SurgeWave® System – All Gliders & Accessories

SurgeWave® System – 6mm SurgeWave® Gliders

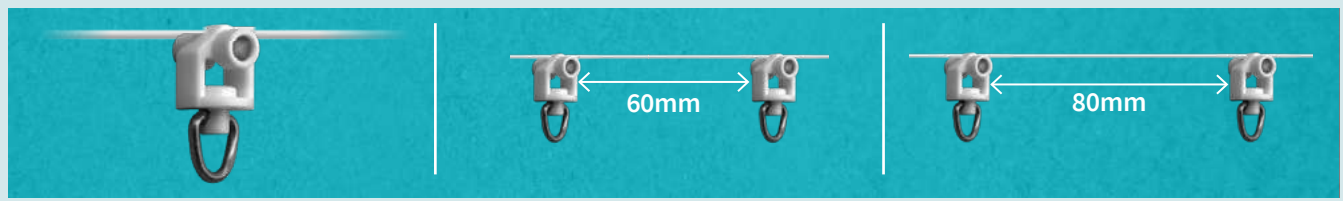

6mm Roller SurgeWave® Gliders on-a-String Narrow

60mm Spacing
○ White

Packed: 30m Roll
Code: 16GL6SR60W

80mm Spacing
○ White

Packed: 40m Roll
Code: 16GL6SR80W

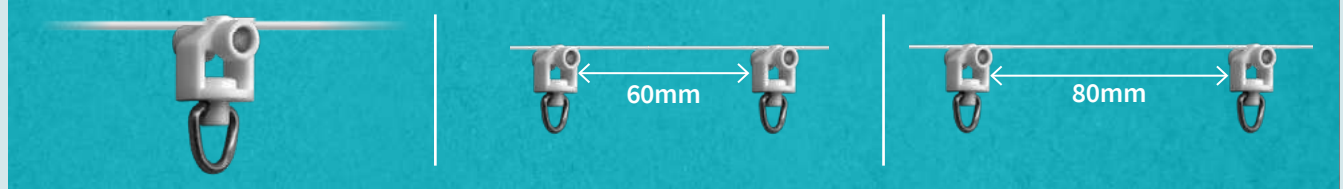

6mm Roller SurgeWave® Gliders on-a-String Wide

60mm Spacing
○ White

Packed: 30m Roll
Code: 16GL7SR60W

80mm Spacing
○ White

Packed: 40m Roll
Code: 16GL7SR80W

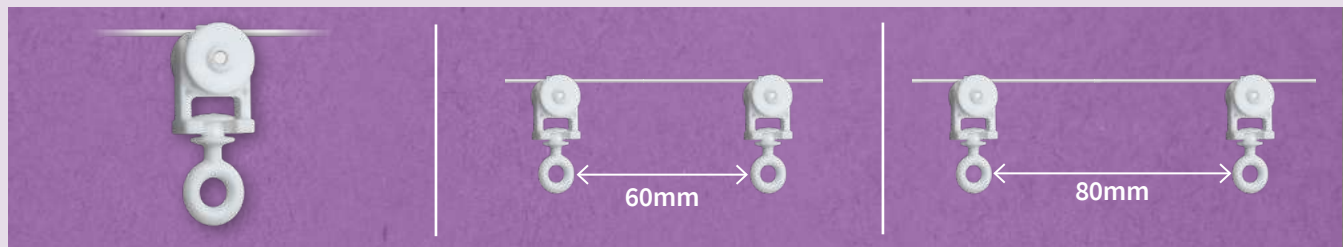

Glide-Aside Roller SurgeWave® Gliders-on-a-String

60mm Spacing
○ White

Packed: 40m Roll
Code: 16GA60RGSW

80mm Spacing
○ White

Packed: 40m Roll
Code: 16GA80RGSW

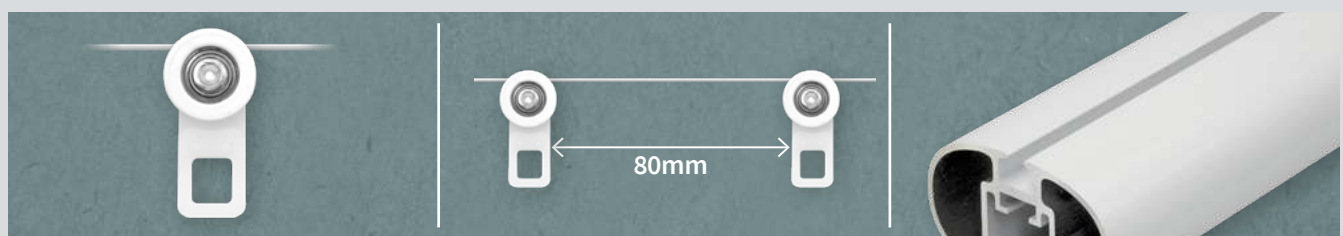

Premium SurgeWave® Roller Gliders For Ocular Track

60mm Spacing
○ White

Packed: 40m Roll
Code: 16OCGLPR8P

SurgeWave® System Accessories



SurgeWave® System Curtain Tape
With 60mm & 80mm Spacing Guides

○ White Packed: 50m Code: 51TOWA3R
○ White Packed: 100m Code: 51TOWA3CR
● Black Packed: 50m Code: 51TOWAK3R
Min Qty: 100m



Iron-on SurgeWave® System Curtain Tape

○ White Packed: 50m Code: 51TOWIA3R
Min Qty: 100m



SurgeWave® Click-In End Lock
For 6mm Channel Tracks only

○ Clear Code: 16SUESCW
Packed: 100 Min Qty: 100



Friction Gliders for SurgeWave® System
Helps prevent curtain spring-back

○ White Packed: 10 Code: 16HSFGDW
○ White Packed: 100 Code: 16HSFGCW
● Grey Packed: 10 Code: 16HSFGDT
● Grey Packed: 100 Code: 16HSFGCT
● Black Packed: 10 Code: 16HSFGDK
● Black Packed: 100 Code: 16HSFGCK

NOTE: Not compatible with Ribbon Gliders



Neat Pleat Guide for SurgeWave® System
Clips onto 4mm & 6mm Gliders

○ White Code: 16SURNP-
Packed: 10 Min Qty: 10

DISCLAIMER: Whilst every effort has been made to ensure colour accuracy, due to the limitations of colour printing, please refer to product samples for colour matching. Product dimensions are for guidance only and may differ – please confirm details at time of ordering.

SurgeWave® System 60mm SurgeWave Glider Count Matrix

Use the table below to calculate the number of hooking points required for **60mm Spaced SurgeWave®** Gliders. Find your **Track Length in mm** in the highlighted column – if your specific length is not shown then you should go up to the next size – e.g. 1100mm would be 20 for single / 12 each for pair (24 total)

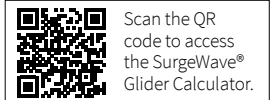

Track Length mm	Single Curtain	Pair (Total)
300	6	
420	8	
540	10	12
660	12	16
780	14	16
900	16	20
1020	18	20
1140	20	24
1260	22	24
1380	24	28
1500	26	28
1620	28	32
1740	30	32
1860	32	36
1980	34	36
2100	36	40
2220	38	40
2340	40	44
2460	42	44
2580	44	48
2700	46	48
2820	48	52
2940	50	52
3060	52	56
3180	54	56
3300	56	60
3420	58	60
3540	60	64
3660	62	64
3780	64	68

Track Length mm	Single Curtain	Pair (Total)
3900	66	68
4020	68	72
4140	70	72
4260	72	76
4380	74	76
4500	76	80
4620	78	80
4740	80	84
4860	82	84
4980	84	88
5100	86	88
5220	88	92
5340	90	92
5460	92	96
5580	94	96
5700	96	100
5820	98	100
5940	100	104
6060	102	104
6180	104	108
6300	106	108
6420	108	112
6540	110	112
6660	112	116
6780	114	116
6900	116	120
7020	118	120
7140	120	124
7260	122	124
7380	124	128

Track Length mm	Single Curtain	Pair (Total)
7500	126	128
7620	128	132
7740	130	132
7860	132	136
7980	134	136
8100	136	140
8220	138	140
8340	140	144
8460	142	144
8580	144	148
8700	146	148
8820	148	152
8940	150	152
9060	152	156
9180	154	156
9300	156	160
9420	158	160
9540	160	164
9660	162	164
9780	164	168
9900	166	168
10020	168	172
10140	170	172
10260	172	176
10380	174	176
10500	176	180
10620	178	180
10740	180	184
10860	182	184
10980	184	188

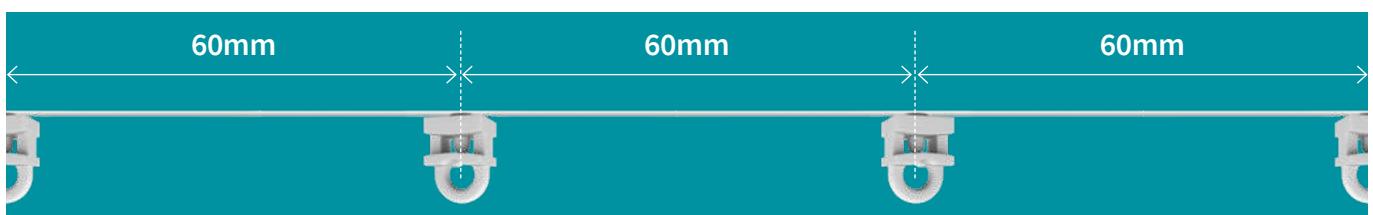

NOTE: For Glide-Aside Tracks the number of SurgeWave Gliders per curtain should be reduced by 3 to allow for the Motor/SurgeWave Arm hooking points.

DISCLAIMER: Whilst every effort has been made to ensure colour accuracy, due to the limitations of colour printing, please refer to product samples for colour matching. Product dimensions are for guidance only and may differ – please confirm details at time of ordering.

SurgeWave® System 80mm SurgeWave Glider Count Matrix

Use the table below to calculate the number of hooking points required for **80mm Spaced SurgeWave®** Gliders. Find your **Track Length in mm** in the highlighted column – if your specific length is not shown then you should go up to the next size – e.g. 1100mm would be 16 for single / 10 each for pair (20 total)

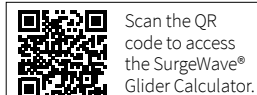

Track Length mm	Single Curtain	Pair (Total)
400	6	
560	8	
720	10	12
880	12	16
1040	14	16
1200	16	20
1360	18	20
1520	20	24
1680	22	24
1840	24	28
2000	26	28
2160	28	32
2320	30	32
2480	32	36
2640	34	36
2800	36	40
2960	38	40
3120	40	44
3280	42	44
3440	44	48
3600	46	48
3760	48	52
3920	50	52
4080	52	56
4240	54	56
4400	56	60
4560	58	60
4720	60	64
4880	62	64
5040	64	68

Track Length mm	Single Curtain	Pair (Total)
5200	66	68
5360	68	72
5520	70	72
5680	72	76
5840	74	76
6000	76	80
6160	78	80
6320	80	84
6480	82	84
6640	84	88
6800	86	88
6960	88	92
7120	90	92
7280	92	96
7440	94	96
7600	96	100
7760	98	100
7920	100	104
8080	102	104
8240	104	108
8400	106	108
8560	108	112
8720	110	112
8880	112	116
9040	114	116
9200	116	120
9360	118	120
9520	120	124
9680	122	124
9840	124	128

Track Length mm	Single Curtain	Pair (Total)
10000	126	128
10160	128	132
10320	130	132
10490	132	136
10650	134	136
10810	136	140
10970	138	140
11130	140	144
11290	142	144
11450	144	148
11610	146	148
11770	148	152
11930	150	152
12090	152	156
12250	154	156
12410	156	160
12570	158	160
12730	160	164
12890	162	164
13050	164	168
13210	166	168
13370	168	172
13530	170	172
13690	172	176
13850	174	176
14010	176	180
14170	178	180
14330	180	184
14490	182	184
14650	184	188

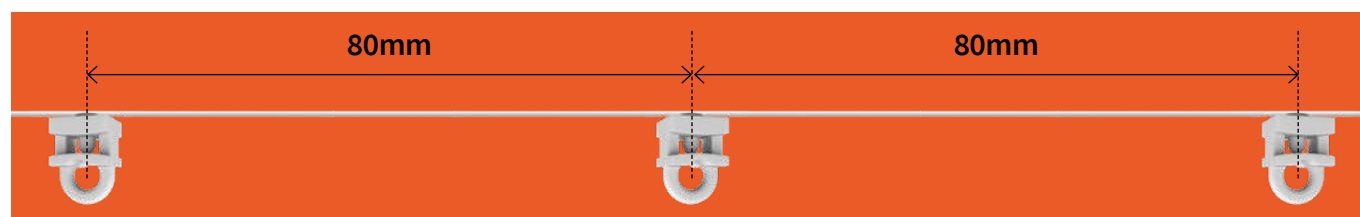

NOTE: For Glide-Aside Tracks the number of SurgeWave Gliders per curtain should be reduced by 3 to allow for the Motor/SurgeWave Arm hooking points.

DISCLAIMER: Whilst every effort has been made to ensure colour accuracy, due to the limitations of colour printing, please refer to product samples for colour matching. Product dimensions are for guidance only and may differ – please confirm details at time of ordering.

SurgeWave® System 4mm Channel Tracks



Contract Solutions
Track Comparison Matrix

	Principal H-Section Profile	Optimal H-Section Profile	Mini Optimal H-Section Profile	Professional Large Curved Profile	Mini Professional Small Curved Profile	Mini U-Section Wall Fix	Mini U-Section Top Fix
Profile Specification							
Weight Capacity	Medium	Medium	Medium	Medium	Medium	Medium	Medium
Corded							
Uncorded (Hand-drawn)	✓	✓	✓	✓	✓	✓	✓
Single Channel Track	✓	✓	✓	✓	✓	✓	✓
Multi-Channel Track							
Brackets & Fixings							
Wall Fix	✓	✓	✓	✓	✓	✓	
Ceiling Fix	✓	✓	✓	✓	✓		✓
Direct Fit without Brackets						✓	✓
Flush Ceiling/Recess Fit							
Adjustable Brackets							
Standard Bracket Colours	○	○	○	○	○		
Leverlock Bracket Colours	○ ● ●			○ ● ● ●			
Colour Options							
White Track RAL 9016	○	○	○	○	○	○	○
Silver Track RAL 9006	●			●	●		
Black Track RAL 9005	●			●			
Additional Colours				<ul style="list-style-type: none"> ● Anthracite ● Sand ● Brushed Steel ● Silver Metallic ● Gold ● Antique Brass 	○ Silver Metallic		
4mm Glider Options							
4mm SurgeWave® Gliders Choose 60mm or 80mm spacing	○ ●	○	○	○ ●	○ ●	○ †	○
Roller SurgeWave® Gliders	Not available for 4mm Grove Tracks – Please see 6mm Profile options						
SurgeWave® Ribbon Choose 60mm or 80mm spacing	Not available for 4mm Grove Tracks – Please see 6mm Profile options						
4mm Standard Glider – Colours	○ ● ●	○	○	○ ● ● ●	○ ● ●	○	○
4mm Standard Roller Glider							
4mm Heavy Duty Glider							
4mm Heavy Duty Roller Glider							
4mm Click-in Gliders (Retro fit)	✓		✓	✓	✓	✓	✓
4mm Overlap Arms	✓	✓	✓	✓	✓	✓	✓
Bending/Angle Options							
Angle Bend Service	✓	✓	✓	✓	✓		
90° Bend Min Radius	10cm	10cm	10cm	10cm	10cm		
Continuous Curve Service	✓	✓	✓	✓	✓		
Bending Tool Option	✓	✓	✓	✓	✓		

† Surge is compatible with Mini U-Section Wall Fix when fitted flush to the base of a recess or flush to the base and rear of a pelmet board.



SurgeWave® System 6mm Channel Tracks



Contract Solutions
Track Comparison Matrix

	Silent Glide	Motiva Round Corded	Motiva Round Uncorded	W-Section	Recess M-Section	Heavy Duty Corded	Heavy Duty H-Section	L-Section	Motiva Flat
Profile Specification									
Max Curtain Weight*	Heavy	Heavy	Heavy	Heavy	Heavy	Heavy	Heavy	Heavy	Heavy
Corded		✓				✓			
Uncorded (Hand-drawn)	✓	✓	✓	✓	✓		✓	✓	✓
Single Channel Track	✓	✓	✓	✓	✓	✓	✓	✓	✓
Multi-Channel Track									
Brackets & Fixings									
Wall Fix (▲ L-Extension required)	✓	✓	✓	▲		▲	✓		✓
Ceiling Fix	✓	✓	✓	✓		✓	✓	✓	✓
Direct Fit without Brackets				✓				✓	
Flush Ceiling/Recess Fit					✓				
Adjustable Brackets		✓	✓						✓
Standard Bracket Colours	○ Hidden	○ ● ●	○ ● ●	○ ●		○	○ ● ●		○ ● ●
Leverlock Bracket Colours							○ ● ●		
Colour Options									
White Track RAL 9016	○	○	○	○	○	○	○	○	○
Silver Track RAL 9006	●	●	●				●		●
Black Track RAL 9005	●	●	●	●			●		●
Additional Colours									
6mm Glider Options									
6mm SurgeWave® Gliders Choose 60mm or 80mm spacing	○ ●	○ ●	○ ●	○ ●††	Not Recommended	○	○ ●	○	○
6mm Roller SurgeWave® Gliders	○	○	○	○	Not Recommended	○	○	○	○
6mm SurgeWave® Ribbon Choose 60mm or 80mm spacing	○ ● ●	○ ● ●	○ ● ●	○ ●	○	○	○ ● ●	○	○ ● ●
6mm Standard Glider – Colours	○ ● ●	○ ● ●	○ ● ●	○ ●	○	○	○ ● ●	○	○ ● ●
6mm Standard Roller Glider	✓	✓	✓	✓	✓	✓	✓	✓	✓
6mm Heavy Duty Glider	✓	✓	✓	✓	✓	✓	✓	✓	✓
6mm Heavy Duty Roller Glider			✓						
6mm Click-in Gliders (Retro fit)	✓	✓	✓	✓	✓	✓	✓	✓	✓
6mm Overlap Arms	✓	✓	✓	✓	✓	✓	✓	✓	✓
Bending/Angle Options									
Angle Bend Service	✓	✓	✓	✓		✓	✓		✓
90° Bend Min Radius	10cm	30cm	30cm	10cm		12.5cm	10cm		10cm
Continuous Curve Service	✓	✓	✓	✓		✓	✓		✓
Bending Tool Option				✓		✓	✓		✓







*Tracks labelled as HEAVY must be used with Heavy Duty Gliders

†† Surge is not compatible with pre-drilled W-Section



SurgeWave® System 6mm Channel Tracks

The Deluxe Collection
Tracks Comparison Matrix

	Distinction 20 Round	Distinction 28 Round Corded	Distinction 28 Round Uncorded	Distinction 34 Flat	Glide-Aside Motorised	Ocular Ellipse Profile
Profile Specification						
Max Curtain Weight	Medium	Medium		Heavy*	Heavy*	Heavy*
Channel Width	6mm	6mm		6mm	6mm	6mm
Corded		✓				
Uncorded (Hand-Drawn)	✓		✓	✓	✓	✓
Single Channel Track	✓	✓	✓	✓	✓	✓
Motorised					✓	
Brackets & Fixings						
Wall Fix	✓	✓		✓	✓	✓
Ceiling Fix	✓	✓		✓	✓	✓
Coloured Brackets	Colour Matched	Colour Matched		Colour Matched		Colour Matched
Colour Options	<p>Standard Colours: <input type="radio"/> White Sheen <input checked="" type="radio"/> Black Sheen <input type="radio"/> Silver Sheen</p> <p>Premium Colours: <input checked="" type="radio"/> Antique Bronze <input type="radio"/> Californian Gold <input checked="" type="radio"/> Hammered Steel <input type="radio"/> Steel Sheen <input checked="" type="radio"/> Burnt Bronze <input type="radio"/> Pearl Beige <input type="radio"/> Light Grey <input type="radio"/> Shaded White</p> <p><input type="radio"/> RAL 9016</p> <p><input type="radio"/> Polar <input type="radio"/> Dune <input type="radio"/> Mist <input type="radio"/> Strom <input checked="" type="radio"/> Noir</p>					
Finial Options						
Standard Finial	End Cap	Barrel Finial	End Cap	End Cap		End Cap
Optional Finials		Sphere Finial	Sphere or Barrel Finial			
Glider Options						
6mm SurgeWave® Gliders Choose 60mm or 80mm spacing	All Distinction Tracks if specified with SurgeWave are supplied with SurgeWave Ribbon Gliders as standard					Ocular Premium SurgeWave Gliders
6mm Roller SurgeWave®	<input type="radio"/>	<input type="radio"/>	<input type="radio"/>	<input type="radio"/>		<input type="radio"/> <input checked="" type="radio"/> <input checked="" type="radio"/> <input checked="" type="radio"/>
6mm SurgeWave® Ribbon Choose 60mm or 80mm spacing	<input type="radio"/> <input checked="" type="radio"/> <input checked="" type="radio"/>	<input type="radio"/> <input checked="" type="radio"/> <input checked="" type="radio"/>	<input type="radio"/> <input checked="" type="radio"/> <input checked="" type="radio"/>	<input type="radio"/> <input checked="" type="radio"/> <input checked="" type="radio"/>		<input type="radio"/> <input checked="" type="radio"/> <input checked="" type="radio"/>
Standard Glider Colours	<input type="radio"/>	<input type="radio"/>	<input type="radio"/>	<input type="radio"/>		
Standard Roller Gliders		<input type="radio"/>	<input type="radio"/>	<input type="radio"/>		Ocular Premium Roller Gliders
Heavy Duty Glider			<input type="radio"/>	<input type="radio"/>		<input type="radio"/> <input checked="" type="radio"/> <input checked="" type="radio"/> <input checked="" type="radio"/>
Overlap Arms	<input type="radio"/>	<input type="radio"/>	<input type="radio"/>	<input type="radio"/>		<input type="radio"/>
Bending Options						
Angle Bend Service	✓	✓	✓	✓	✓	
90° Bend Min Radius	10cm	10cm	10cm	10cm	40cm	
Continuous Curve Service	✓	✓	✓	✓		
Curve Min Radius	10cm	10cm	10cm	10cm		
Additional Options						
LED Strip Lighting						✓
Motorised Operation Choose Battery or Mains Power					✓	
Handheld Remote Control					✓	
Smart Home Compatible					✓	

*Tracks labelled as HEAVY must be used with Heavy Duty Gliders

Next day delivery on stocked items only. Made-to-measure & bending lead times vary depending on quantities. Please call to discuss your requirements so we can give you accurate timescales. T&Cs apply.



RENAISSANCE



MULTI-CHANNEL TRACKS

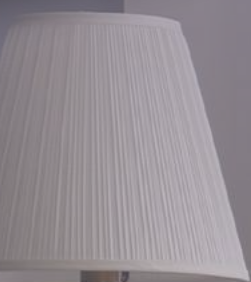

MULTI-CHANNEL TRACKS



RENAISSANCE

TEL 0113 250 4499

• EMAIL SALES@RCA-UK.COM

• VISIT RCA-UK.COM

Aluminium Project Curtain Tracks – 6mm Multi-Channel Tracks

6mm Multi-Channel Aluminium Tracks



Double Project Track – Recess Fixed 6mm Channel

Size: 6m (19'8")

White

Code: 16PR2600W

Packed: 5 Lengths Min Qty: 5

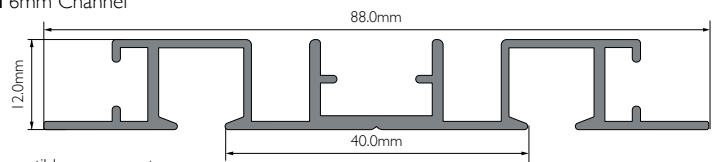

Please see page 183 for more details and compatible components.

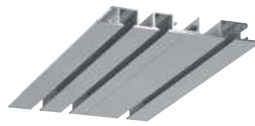

Triple Project Track – Recess Fixed 6mm Channel

Size: 6m (19'8")

White

Code: 16PR3600W

Packed: 5 Lengths

Min Qty: 5

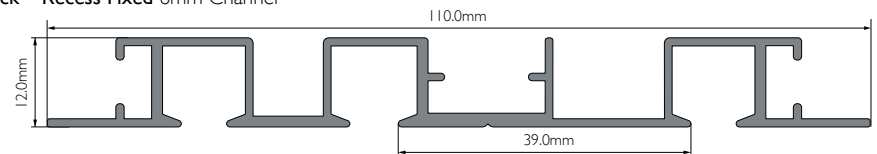

Please see page 183 for more details and compatible components.



Double Project Track – Ceiling Fixed 6mm Channel

Size: 4m (13'1")

White

Code: 16PC2400W

Packed: 5 Lengths Min Qty: 5

Size: 6m (19'8")

White

Code: 16PC2600W

Packed: 5 Lengths Min Qty: 5

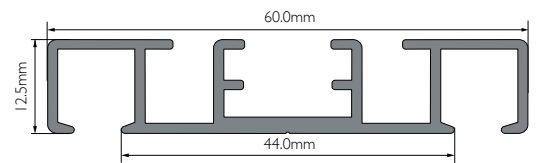

Please see page 184 for more details and compatible components.

NOTE: If there is volume required, this track can have pre-punched holes for fixing direct through.



Triple Project Track – Ceiling Fixed 6mm Channel

Size: 4m (13'1")

White

Code: 16PC3400W

Packed: 5 Lengths Min Qty: 5

Size: 6m (19'8")

White

Code: 16PC3600W

Packed: 5 Lengths Min Qty: 5

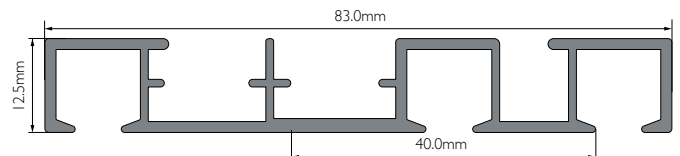

Please see page 184 for more details and compatible components.

NOTE: If there is volume required, this track can have pre-punched holes for fixing direct through.



Slimline Project Ceiling Fixed Double Track 6mm Channel

Size: 6m (19'8")

White

Code: 16PS2600W

Packed: 10 Lengths Min Qty: 10

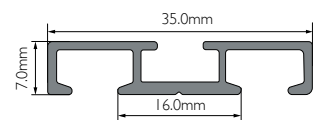

Please see page 186 for more details and compatible components.

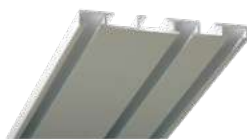

Slimline Project Ceiling Fixed Triple Track 6mm Channel

Size: 6m (19'8")

White

Code: 16PS3600W

Packed: 10 Lengths Min Qty: 10

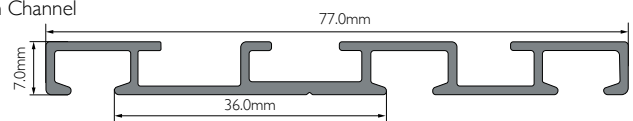

Please see page 186 for more details and compatible components.

Project Track – Recess Fix

Double/Triple Channel Systems

Recessed Project track has the benefits and functions of standard Project Track for multi-layered curtains, with the additional feature of its design to fit flush into the ceiling for an ultimate smooth appearance.

Project Track is fast to fit and should be fixed to ceiling joists or constructional components commensurate with the load requirement of the track system. Available as double and triple track systems.



‡ Pre-drilled Track with 40cm space between holes

Double Project Pre-drilled‡ Track – Recess Fix 6mm Channel

Size: 6m (19'8")

White

Code: 16PR2600W

Packed: 5 Lengths

Min Qty: 5

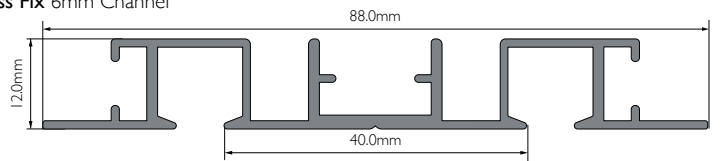

‡ Pre-drilled Track with 40cm space between holes

Triple Project Pre-drilled‡ Track – Recess Fix 6mm Channel

Size: 6m (19'8")

White

Code: 16PR3600W

Packed: 5 Lengths

Min Qty: 5

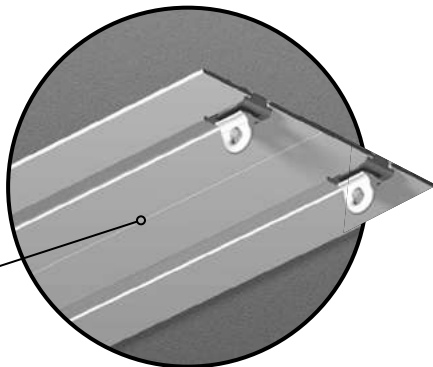
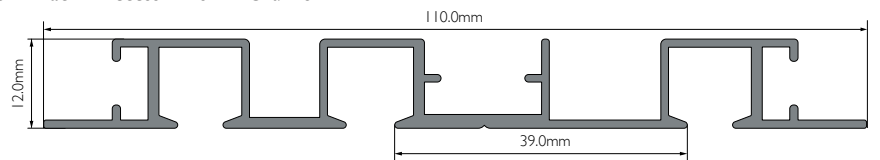

Project Track has a central Locator Groove for accurate positioning of additional fixing holes if required.

Colour finish available:

WHITE
RAL 9016

For Curtain Hooks see this Catalogue page 217



Project Track Recess Fix Track Kit Components

NOTE: Kits are available up to the size ordered and can also be produced to your specific size.

Components	Track Kit Sizes							
	1.00m (3'3")	1.50m (4'11")	2.00m (6'7")	2.50m (8'2")	3.00m* (9'10")	4.00m* (13'1")	5.00m* (16'5")	6.00m* (19'8")
Profile Track	1 x 1.00m	1 x 1.50m	1 x 2.00m	1 x 2.50m	2 x 1.50m	2 x 2.00m	2 x 2.50m	2 x 3.00m
End Caps	2	2	2	2	2	2	2	2
Twist End Stops [^]	2	2	2	2	2	2	2	2
Standard Gliders [^]	10	16	20	26	30	40	50	60
Double Channel Kit	16PR2US100W	16PR2US150W	16PR2US200W	16PR2US250W	16PR2US300W	16PR2US400W	16PR2US500W	16PR2US600W
Triple Channel Kit	16PR3US100W	16PR3US150W	16PR3US200W	16PR3US250W	16PR3US300W	16PR3US400W	16PR3US500W	16PR3US600W

Packed: 1 px / Outer 5 Min Qty: 1

[^]Number per Channel (so for Double x2 for Triple x3). Please specify if you have alternative requirements for the number of gliders per channel due to your unique design.

*Denotes 2 piece profile with joiner. All kits include fittings.



This curtain track is suitable for medium-to-heavy weight curtains



Suitable for straight runs ONLY



Kits/components are delivered in transport packaging



Available in contract components for large jobs



Available in kit form for simple ordering



Tracks available made-to-measure

DISCLAIMER: Whilst every effort has been made to ensure colour accuracy, due to the limitations of colour printing, please refer to product samples for colour matching. Product dimensions are for guidance only and may differ – please confirm details at time of ordering.

Project Track – Ceiling Fix

Double/Triple Channel Systems

Project Track is a highly functional and quickly constructed tracking system when multi-layered curtain effects are required. Designed for ceiling fix, Project Track may also be wall fixed with L-Brackets, and its fast construction saves costly fitting time compared to multiple individual tracks.

Project Track may be corner jointed, or jointed to offer unlimited length of tracking, for a neat uncluttered appearance between walls. Project track may be fitted with intermediate stops to define specific windows or design elements as required. Available as double and triple track systems.

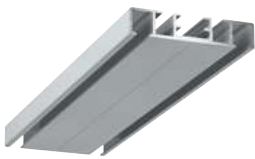
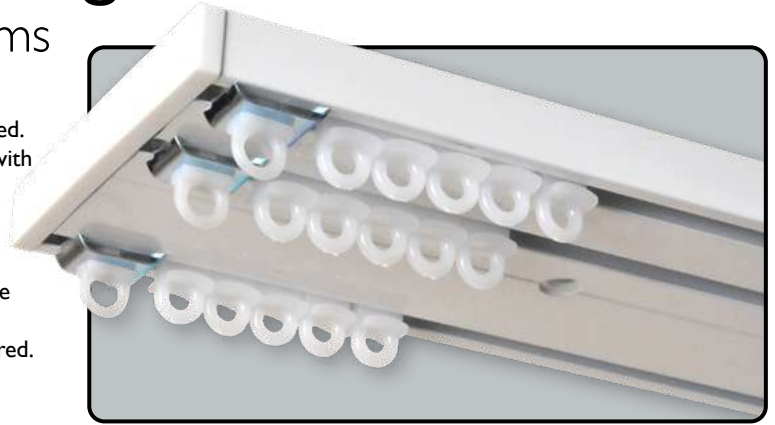

Double Project Pre-drilled[‡] Track – Ceiling Fix 6mm Channel

Size: 4m (13'1") White Code: 16PC2400W

Size: 6m (19'8") White Code: 16PC2600W

Packed: 5 Lengths Min Qty: 5

‡ Pre-drilled Track with 40cm space between holes

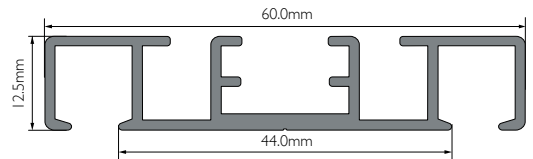

Triple Project Pre-drilled[‡] Track – Ceiling Fix 6mm Channel

Size: 4m (13'1") White Code: 16PC3400W

Size: 6m (19'8") White Code: 16PC3600W

Packed: 5 Lengths Min Qty: 5

‡ Pre-drilled Track with 40cm space between holes

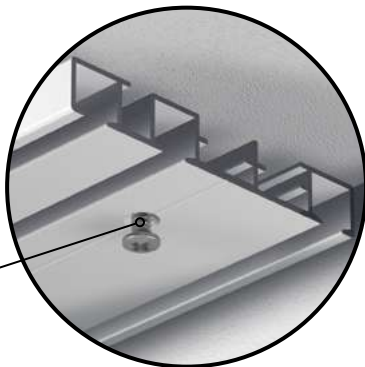
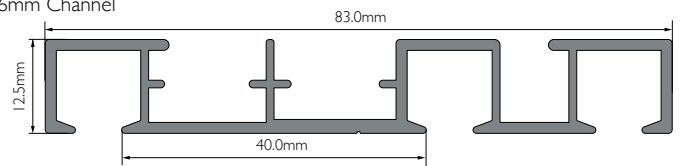

Project Track has a central Locator Groove for accurate positioning of additional fixing holes if required.

Colour finish available:

WHITE
RAL 9016

For Curtain Hooks see this Catalogue page 217



Project Track Ceiling Fix Track Kit Components

NOTE: Kits are available up to the size ordered and can also be produced to your specific size.

Components	Track Kit Sizes							
	1.00m (3'3")	1.50m (4'11")	2.00m (6'7")	2.50m (8'2")	3.00m* (9'10")	4.00m* (13'1")	5.00m* (16'5")	6.00m* (19'8")
Profile Track	1 x 1.00m	1 x 1.50m	1 x 2.00m	1 x 2.50m	2 x 1.50m	2 x 2.00m	2 x 2.50m	2 x 3.00m
End Caps	2	2	2	2	2	2	2	2
Twist End Stops [^]	2	2	2	2	2	2	2	2
Standard Gliders [^]	10	16	20	26	30	40	50	60
Double Channel Kit	16PC2US100W	16PC2US150W	16PC2US200W	16PC2US250W	16PC2US300W	16PC2US400W	16PC2US500W	16PC2US600W
Triple Channel Kit	16PC3US100W	16PC3US150W	16PC3US200W	16PC3US250W	16PC3US300W	16PC3US400W	16PC3US500W	16PC3US600W

Packed: 1 px/Outer 5 Min Qty: 1

[^]Number per Channel (so for Double x2 for Triple x3). Please specify if you have alternative requirements for the number of gliders per channel due to your unique design.

*Denotes 2 piece profile with joiner. All kits include fittings. † For Wall Fix please add L-Extension Brackets to your order.



This curtain track is suitable for medium-to-heavy weight curtains



Suitable for straight runs ONLY



Kits/components are delivered in transport packaging



Available in contract components for large jobs



Available in kit form for simple ordering



Tracks available made-to-measure

DISCLAIMER: Whilst every effort has been made to ensure colour accuracy, due to the limitations of colour printing, please refer to product samples for colour matching. Product dimensions are for guidance only and may differ – please confirm details at time of ordering.



Project Track – Accessories

Gliders & Overlap Arms

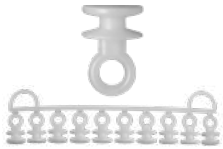

Caraglidert – Strips of 10 6mm Channel

White Code: 16HO999W
Packed: 1000 Min Qty: 1000



Roller Gliders – Strips of 10 for 6mm Channel

White Packed: 100 Code: 16HO025W
 White Packed: 1000 Code: 16HO025KW
Min Qty: 100



Standard Gliders – Strips of 10 6mm Channel

White Code: 16HO738W
Packed: 2000 Min Qty: 1000



Click-in Glider for 6mm Channel tracks

White Code: 16HO998W
Packed: 1000 Min Qty: 1000



Standard Gliders with Large Metal S-Hook

White Code: 16HO996W
Packed: 100 Min Qty: 100

Standard Gliders with Small Metal S-Hook

White Code: 16HO990W
Packed: 100 Min Qty: 100



Caraglidert with Large Metal S-Hook

White Code: 16HO994W
Packed: 100 Min Qty: 100

Caraglidert with Large Plastic S-Hook

White Code: 16HO991W
Packed: 100 Min Qty: 100



Heavy Duty Gliders for 6mm Channel tracks

White Code: 16HD307W
Packed: 100 Min Qty: 10

These Glider Attachments can be added to gliders with an 'eye' to connect to curtains



Plastic S-Hook Code: 16HO995W
Packed: 1000 Min Qty: 1000

Large Metal S-Hook 39mm Code: 16HO072S

Small Metal S-Hook 29mm Code: 16HO071S

Packed: 100 Min Qty: 100



6mm Overlap Arm

Compatible with all gliders except for Heavy Duty

Silver Code: 16WSOL1-
Packed: 1 Min Qty: 1



Heavy Duty Underlap Arm ^Δ 6mm Channel

White Code: 16HD301W
Packed: 10 Min Qty: 10



Heavy Duty Overlap Arm ^Δ 6mm Channel

White Code: 16HD303W
Packed: 10 Min Qty: 10

^Δ Compatible when using Heavy Duty Gliders **ONLY**

End Stops



Large Metal Mid Stop for 6mm Channel

Silver Code: 16HO044S
Packed: 100 Min Qty: 100



Large Twist Fit End Stop for 6mm Channel

White Code: 16HO744W
Packed: 100 Min Qty: 100



Large Metal Twist Stop for 6mm Channel

Silver Code: 16HO997S
Packed: 100 Min Qty: 100

End Caps for Ceiling Fix



Double Project Track Ceiling Fixed End Cap

White Code: 16PC2ECW
Packed: 100 Min Qty: 10



Triple Project Track Ceiling Fixed End Cap

White Code: 16PC3ECW
Packed: 100 Min Qty: 10



Joiners



Project Track Joiner

White Code: 16PTJO1W
Packed: 100 Min Qty: 10



Project Track Corner Connector

Silver Code: 16PTCORS
Packed: 50 Min Qty: 10



DISCLAIMER: Whilst every effort has been made to ensure colour accuracy, due to the limitations of colour printing, please refer to product samples for colour matching. Product dimensions are for guidance only and may differ – please confirm details at time of ordering.

Slim-line Project Ceiling Fix

Double/Triple Channel Systems

Slim-line Project Track is a highly functional and quickly constructed tracking system when multi-layered curtain effects are required. Designed to fit directly to ceiling, Slim-line Project is available in a Double and Triple Channel profiles – both feature a handy central location groove ease and accurate positioning of drilling holes for fixing points.

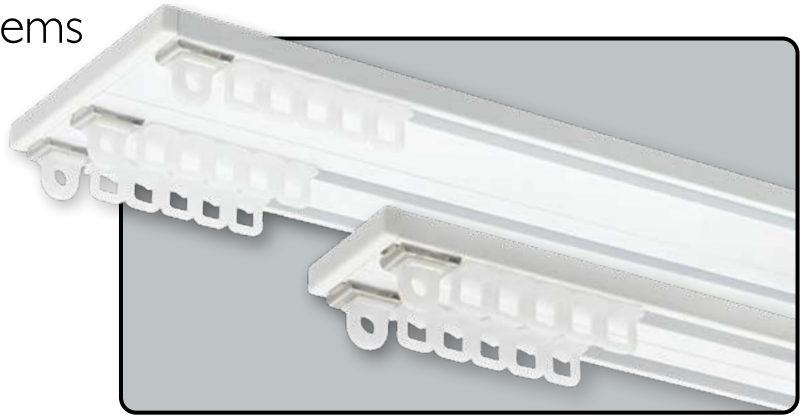

For Curtain Hooks see this Catalogue page 217



Double Slim-line Project Track Ceiling Fix 6mm Channel
 Size: 6m (19'8") White Code: 16PS2600W
 Packed: 5 Lengths Min Qty: 5

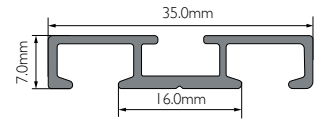

Triple Slim-line Project Track Ceiling Fix 6mm Channel
 Size: 6m (19'8") White Code: 16PS3600W
 Packed: 5 Lengths Min Qty: 5

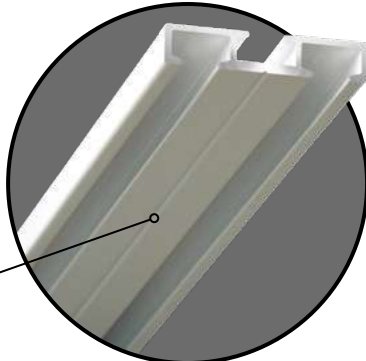
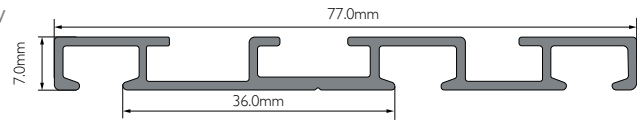

Slim-line Project Track has a central Locator Groove for ease and accurate positioning of drilling holes for fixing points.

Colour finish available:
WHITE
 RAL 9016

For Curtain Hooks see this Catalogue page 217

Slim-line Project Track Ceiling Fix Track Kit Components

NOTE: Kits are available up to the size ordered and can also be produced to your specific size.

Components	Track Kit Sizes							
	1.00m (3'3")	1.50m (4'11")	2.00m (6'7")	2.50m (8'2")	3.00m* (9'10")	4.00m* (13'1")	5.00m* (16'5")	6.00m* (19'8")
Profile Track	1 x 1.00m	1 x 1.50m	1 x 2.00m	1 x 2.50m	2 x 1.50m	2 x 2.00m	2 x 2.50m	2 x 3.00m
End Caps	2	2	2	2	2	2	2	2
Twist End Stops^	2	2	2	2	2	2	2	2
Standard Gliders^	10	16	20	26	30	40	50	60
Double Channel Kit†	16PS2US100W	16PS2US150W	16PS2US200W	16PS2US250W	16PS2US300W	16PS2US400W	16PS2US500W	16PS2US600W
Triple Channel Kit†	16PS3US100W	16PS3US150W	16PS3US200W	16PS3US250W	16PS3US300W	16PS3US400W	16PS3US500W	16PS3US600W

Packed: 1 px/Outer 5 Min Qty: 1

^Number per Channel (so for Double x2 and for Triple x3). Please specify if you have alternative requirements for the number of gliders per channel due to your unique design.
 *Denotes 2 piece profile with joiner. All kits include fittings. † For Wall Fix please add L-Extension Brackets to your order.

<p>This curtain track is suitable for medium-to-heavy weight curtains</p>	<p>Suitable for straight runs ONLY</p>	<p>Kits/components are delivered in transport packaging</p>	<p>Available in contract components for large jobs</p>	<p>Available in kit form for simple ordering</p>	<p>Tracks available made-to-measure</p>
---	--	---	--	--	---

DISCLAIMER: Whilst every effort has been made to ensure colour accuracy, due to the limitations of colour printing, please refer to product samples for colour matching. Product dimensions are for guidance only and may differ – please confirm details at time of ordering.

Slim-line Project Track – Accessories

Gliders & Overlap Arms



Caraglidder – Strips of 10 6mm Channel

White Code: 16HO999W
Packed: 1000 Min Qty: 1000



Roller Gliders – Strips of 10 for 6mm Channel

White Packed: 100 Code: 16HO025W
 White Packed: 1000 Code: 16HO025KW
Min Qty: 100



Standard Gliders – Strips of 10 6mm Channel

White Code: 16HO738W
Packed: 2000 Min Qty: 1000



Click-in Glider for 6mm Channel tracks

White Code: 16HO998W
Packed: 1000 Min Qty: 1000



Standard Gliders with Large Metal S-Hook

White Code: 16HO996W
Packed: 100 Min Qty: 100

Standard Gliders with Small Metal S-Hook

White Code: 16HO990W
Packed: 100 Min Qty: 100



Caraglidder with Large Metal S-Hook

White Code: 16HO994W
Packed: 100 Min Qty: 100

Caraglidder with Large Plastic S-Hook

White Code: 16HO991W
Packed: 100 Min Qty: 100



Heavy Duty Gliders for 6mm Channel tracks

White Code: 16HD307W
Packed: 100 Min Qty: 10

These Glider Attachments can be added to gliders with an 'eye' to connect to curtains



Plastic S-Hook Code: 16HO995W
Packed: 1000 Min Qty: 1000

Large Metal S-Hook 39mm Code: 16HO072S

Small Metal S-Hook 29mm Code: 16HO071S
Packed: 100 Min Qty: 100



6mm Overlap Arm

Compatible with all gliders except for Heavy Duty
 Silver Code: 16WSOLI-
Packed: 1 Min Qty: 1



Heavy Duty Underlap Arm ^Δ 6mm Channel

White Code: 16HD301W
Packed: 10 Min Qty: 10



Heavy Duty Overlap Arm ^Δ 6mm Channel

White Code: 16HD303W
Packed: 10 Min Qty: 10

^Δ Compatible when using Heavy Duty Gliders **ONLY**

End Caps



Slim-line Project Track Ceiling Fix Double Channel End Cap

White Code: 16PS2ECW
Packed: 100 Min Qty: 10



Slim-line Project Track Ceiling Fix Triple Channel End Cap

White Code: 16PS3ECW
Packed: 100 Min Qty: 10

End Stops



Large Metal Mid Stop for 6mm Channel

Silver Code: 16HO044S
Packed: 100 Min Qty: 100



Large Twist Fit End Stop for 6mm Channel

White Code: 16HO744W
Packed: 100 Min Qty: 100



Large Metal Twist Stop for 6mm Channel

Silver Code: 16HO997S
Packed: 100 Min Qty: 100

Panel Track Headrail

Top-fix & Wall-fix Systems

Renaissance panel track systems. Contemporary window treatment for solar control and privacy, or can be applied as decorative room divider. Option available for cord drawn or hand drawn panels.

Available in component form or made to measure. Headrails available with 2, 3, 4 or 5-Channels for different panel applications and different size requirements. Made-to-measure hand drawn options include draw rods for operation. Almost any size can be made for partitioning and used for continuous curtaining or multiple layers.

NOTE: Panel Track is special order only – please ask for lead times.



Panel Track 2-Channel Headrail 6mm Channel

Size: 6m (19'8") White
Code: 16PAN402
Packed: 5 Lengths **Min Qty:** 5

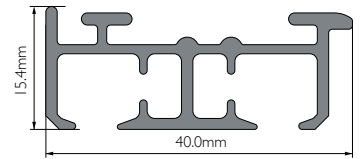

Panel Track 3-Channel Headrail 6mm Channel

Size: 6m (19'8") White
Code: 16PAN403
Packed: 5 Lengths **Min Qty:** 5

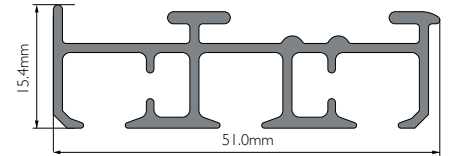

Panel Track 4-Channel Headrail 6mm Channel

Size: 6m (19'8") White
Code: 16PAN404
Packed: 5 Lengths **Min Qty:** 5

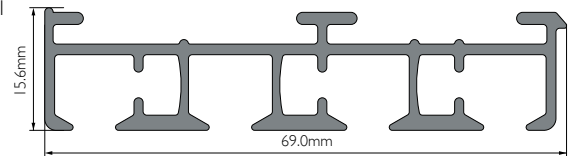

Panel Track 5-Channel Headrail 6mm Channel

Size: 6m (19'8") White
Code: 16PAN405
Packed: 5 Lengths **Min Qty:** 5

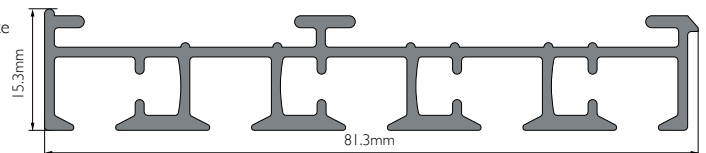

Panel Track 2-Channel Wall-fix Headrail 6mm Channel

Size: 6m (19'8") White
Code: 16PAN406
Packed: 5 Lengths **Min Qty:** 5

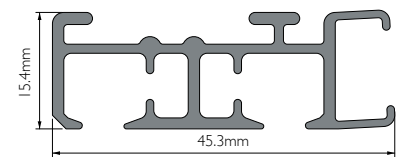

Panel Track 3-Channel Wall-fix Headrail 6mm Channel

Size: 6m (19'8") White
Code: 16PAN407
Packed: 5 Lengths **Min Qty:** 5

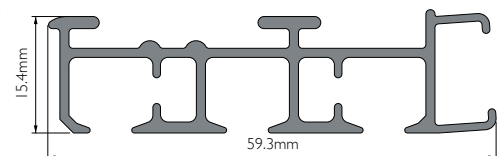

Made-to-measure price: Any style of stacking will be the same price as the price is calculated per metre – see options on next page.

<p>This Panel track is suitable for medium-to-heavy weight material</p>	<p>Suitable for straight runs ONLY</p>	<p>Kits/components are delivered in transport packaging</p>	<p>Available in contract components for large jobs</p>	<p>Available in kit form for simple ordering</p>	<p>Tracks available made-to-measure</p>
---	--	---	--	--	---

DISCLAIMER: Whilst every effort has been made to ensure colour accuracy, due to the limitations of colour printing, please refer to product samples for colour matching. Product dimensions are for guidance only and may differ – please confirm details at time of ordering.

Panel Track Systems – Draw Options

When ordering – please state:

- Your chosen **Option Ref** (e.g D-3)
- Hand drawn, cord drawn – if cord drawn state left or right-hand control
- Length of cord drop required
- Ceiling or wall fix
- Complete length of Track

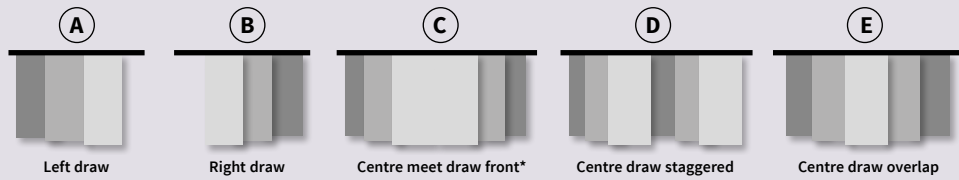

2 Channel

Ceiling or Wall Fix



CLOSED		OPTION REF	OPEN		CORDED OPTION
		A-2			✓
		B-2			✓
		C-2			✗
		D-2			✓

3 Channel

Ceiling or Wall Fix

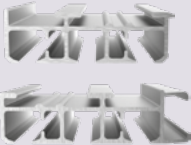

CLOSED		OPTION REF	OPEN		CORDED OPTION
		A-3			✓
		B-3			✓
		C-3			✗
		D-3			✓
		E-3			✗

4 Channel

Ceiling Fix



CLOSED		OPTION REF	OPEN		CORDED OPTION
		A-4			✓
		B-4			✓
		C-4			✗
		D-4			✓
		E-4			✓

5 Channel

Ceiling Fix



CLOSED		OPTION REF	OPEN		CORDED OPTION
		A-5			✓
		B-5			✓
		C-5			✗
		D-5			✓
		E-5			✓

*C Option is also available as centre meet draw back – please specify if required.

General recommendation for calculating Panel size: Length of track divided by number of Panels + 50mm per Panel for overlap. Tracks made to specification, please specify all details.

DISCLAIMER: Whilst every effort has been made to ensure colour accuracy, due to the limitations of colour printing, please refer to product samples for colour matching. Product dimensions are for guidance only and may differ – please confirm details at time of ordering.

Panel Track – Accessories

Panel Track Wall-Fix Brackets



Ceiling Standard Bracket (with Slot)

White Code: 16HSBCCW
Packed: 100 Min Qty: 100



Ceiling Standard Bracket (with Hole)

White Code: 16HSBHCW
Packed: 100 Min Qty: 100



4cm Standard Wall/Ceiling Bracket

White Code: 16HSB4CW
Packed: 100 Min Qty: 100



6cm Standard Wall/Ceiling Bracket

White Code: 16HSB6CW
Packed: 100 Min Qty: 100



3cm Click Wall/Ceiling Bracket

White Code: 16HSC3CW
Packed: 100 Min Qty: 100



4cm Click Wall/Ceiling Bracket

White Code: 16HSC4CW
Packed: 100 Min Qty: 100



5cm Click Wall/Ceiling Bracket

White Code: 16HSC5CW
Packed: 100 Min Qty: 100



4cm Leverlock Wall/Ceiling Bracket

White Code: 16HSL4CW
Packed: 100 Min Qty: 100



5cm Leverlock Wall/Ceiling Bracket

White Code: 16HSL5CW
Packed: 100 Min Qty: 100



6cm Leverlock Wall/Ceiling Bracket

White Code: 16HSL6CW
Packed: 100 Min Qty: 100



Ceiling Leverlock Bracket (with Hole)

White Code: 16HSLCCW
Packed: 100 Min Qty: 100



Flush Wall Fix Bracket

White Code: 16HSFBCW
Packed: 100 Min Qty: 100



Panel Track Headrail Top-Fix Brackets



Panel Track Top-fix Bracket for 2, 3 or 4-Channel Tracks

White Code: 16PAN420

Packed: 100
Min Qty: 10



Panel Track Swivel Bracket for 2, 3 or 4-Channel Tracks

White Code: 16PAN426

Packed: 100
Min Qty: 10



Panel Track Top-fix Bracket for 5-Channel Track

White Code: 16PAN425
Packed: 100 Min Qty: 10



Panel Track Swivel Bracket for 5-Channel Track

White Code: 16PAN428
Packed: 100
Min Qty: 10



End Stops



Large Metal Mid Stop for 6mm Channel

Silver Code: 16HO044S
Packed: 100 Min Qty: 100



Large Twist Fit End Stop for 6mm Channel

White Code: 16HO744W
Packed: 100 Min Qty: 100



Large Metal Twist Stop for 6mm Channel

Silver Code: 16HO997S
Packed: 100 Min Qty: 100

Panel Track Gliders



Panel Track Roller Glider for 6mm Channel

White Code: 16PAN328
Packed: 10 Min Qty: 10



Panel Track Click Glider for 6mm Channel

White Code: 16PAN329
Packed: 10 Min Qty: 10

Joiners

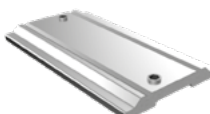

Panel Track Joiner for 2, 3 & 4-Channel Track

Silver Code: 16PAN020
Packed: 10 Min Qty: 10

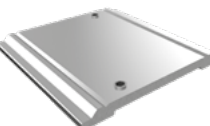

Panel Track Joiner for 5-Channel Track

Silver Code: 16PAN021
Packed: 10 Min Qty: 10

DISCLAIMER: Whilst every effort has been made to ensure colour accuracy, due to the limitations of colour printing, please refer to product samples for colour matching. Product dimensions are for guidance only and may differ – please confirm details at time of ordering.

Panel Track – Accessories

End Caps



Panel Track 2-Channel Track Uncorded End Cap & Cover

White Code: 16PAN409
Packed: 10 Min Qty: 10



Panel Track 3-Channel Track Uncorded End Cap & Cover

White Code: 16PAN410
Packed: 10 Min Qty: 10



Panel Track 4-Channel Track Uncorded End Cap & Cover

White Code: 16PAN410
Packed: 10 Min Qty: 10



Panel Track 5-Channel Track Uncorded End Cap & Cover

White Code: 16PAN411
Packed: 10 Min Qty: 10

Other Accessories



Panel Track Panel Carrier 6m

Panels are fixed to these

White Code: 16PAN320
Packed: 10 Min Qty: 10



Panel Track T-Guide

White Code: 16PAN326
Packed: 10 Min Qty: 10



Panel Track L-Guide

White Code: 16PAN325
Packed: 10 Min Qty: 10



Panel Track Eye for draw rod attachment

White Code: 16PAN333
Packed: 10 Min Qty: 10



Panel Track Bottom Panel Weight Bar 6m

White Code: 16PAN998
Packed: 10 Min Qty: 10

Cording Accessories



Panel Track Cord Guide & Stop Ring

White Code: 16PAN412
Packed: 10 Min Qty: 10



Panel Track 2-Channel Track Corded End Cap & Cover

White Code: 16PAN412
Packed: 10 Min Qty: 10

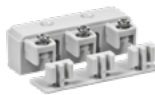

Panel Track 3-Channel Track Corded End Cap & Cover

White Code: 16PAN413
Packed: 10 Min Qty: 10

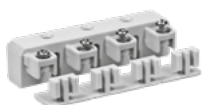

Panel Track 4-Channel Track Corded End Cap & Cover

White Code: 16PAN414
Packed: 10 Min Qty: 10



Panel Track 5-Channel Track Corded End Cap & Cover

White Code: 16PAN415
Packed: 10 Min Qty: 10

Corded Accessories



Panel Track Cord 3.2mm

White Code: 16MOC32W
Packed: 500m Min Qty: 10m



Safety Boxes

Single Safety Box Code: 58WASBSG
Double Safety Box Code: 58WASBDB
Packed: 100 Min Qty: 10



Safety Warning Tag with string

Code: 58WASTST
Packed: 100 Min Qty: 10



Clear Safety Cord Guide

Code: 58WASCCL
Packed: 100 Min Qty: 100



Cord Tensioners

Metal Tensioner Code: 18CTCTMW
Plastic Tensioner Code: 18CTCTPW
Packed: 1 px/Outer 10

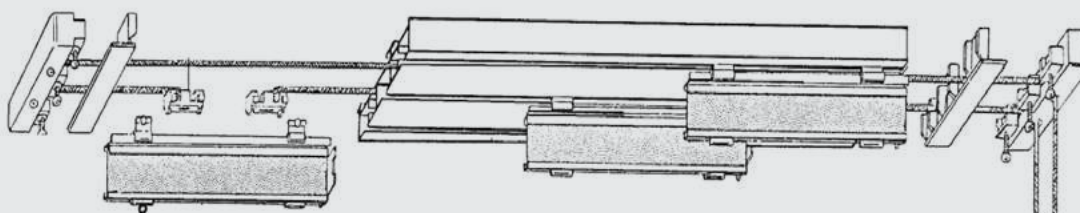

CHILD SAFETY FIRST!



DISCLAIMER: Whilst every effort has been made to ensure colour accuracy, due to the limitations of colour printing, please refer to product samples for colour matching. Product dimensions are for guidance only and may differ – please confirm details at time of ordering.

Draw Rods

Metal Draw Rods



Contemporary Steel Draw Rod

Sizes: 100cm, 125cm, 150cm, 200cm[†]

[†]200cm is a special order product and may have a longer lead time

*Titanium Draw Rods coordinate very well with all Brushed Nickel & Stainless Steel Pole Kits.



Clip Detail

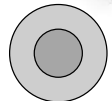

14mm Handle | 7mm Body



Plastic Coated Steel Draw Rod

Sizes: 50cm, 75cm, 100cm, 125cm, 150cm



Clip Detail



10mm Handle | 5mm Body



Style Aluminium Draw Rod

Sizes: 100cm, 125cm, 150cm

Handle Detail



9mm Hollow Rod

Plastic Draw Rods



Luxury Clear Acrylic Draw Rod

Sizes: 75cm, 100cm, 125cm, 150cm, 200cm



Clip Detail



12mm Rod



Clear Acrylic Draw Rod with Steel Core Sizes: 75cm, 100cm, 125cm, 150cm

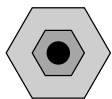

15mm Handle | 8mm Body

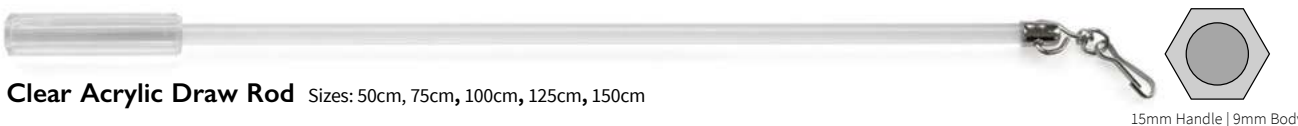

Clear Acrylic Draw Rod Sizes: 50cm, 75cm, 100cm, 125cm, 150cm

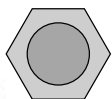

15mm Handle | 9mm Body

DISCLAIMER: Whilst every effort has been made to ensure colour accuracy, due to the limitations of colour printing, please refer to product samples for colour matching. Product dimensions are for guidance only and may differ – please confirm details at time of ordering.



CHILD SAFE
APPROVED



RENAISSANCE

ROMAN BLIND SYSTEMS & ACCESSORIES

ROMAN BLIND SYSTEMS & ACCESSORIES



RENAISSANCE

TEL 0113 250 4499



EMAIL SALES@RCA-UK.COM



VISIT RCA-UK.COM

193

MOTORISED

Motorised Cassette System AutoMoto™

FAST»»FIT
TAB-LOCK CORD ROLLER

Key Features:



IN-STOCK DELIVERY



MADE TO MEASURE



KITS AVAILABLE



REMOTE OPERATION

Ideal for use in:



HOMES & DOMESTIC



OFFICES & HOTELS



CHILD SAFE PRODUCT

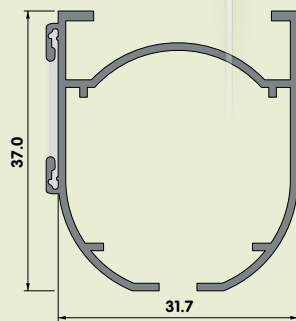

Cassette Material
Aluminium alloy 6060/T6



- ✓ Simple to use and is inherently child safe
- ✓ No chain required – ideal for care homes

Renaissance Closed Cassette System can be easily motorised by using our bespoke motor and accessories that integrate very neatly and compactly within the cassette headrail.

The operation of the blind system can be controlled by various means; with options including light sensors, time sensors, manual switching or remote control.

Various intelligent systems are also available for operating either individual or multiple systems.

Features Include:

- Neat enclosed integrated system only protrudes 38mm when face fixed
- Pre-assembled to required size.
- Simple to operate low noise emission
- Blinds can be easily removed for washing

Technical specification including wiring details available on request.

Wiring specifications/multiple blind operation: Savings can be achieved if operating more than one blind at a time, as not all components need to be repeated for each blind. Price on application – tailored to your specific requirements. Please ask for details and prices.

NOTE: The minimum width for an AutoMoto Cassette is 40cm



All Closed Cassette System Kits are compliant to BS EN 3120:2009+A1:2014 Child Safety Standards.

FAST»»FIT
TAB-LOCK CORD ROLLER

The uniquely designed Fast-Fit Tab Lock Cord Roller from Renaissance with amazing time-saving features now available in AutoMoto kits!



NO SCREWS REQUIRED



AUTO-LOCATE

The uniquely designed chamfered mechanism automatically adjusts to fit the headrail axle bar.



TAB-LOCK

To securely lock the roller in place simply twist the Easy-Lock Tab 90° in either direction.



QUICK ADJUST

So simple to adjust – just twist the tab and slide in either direction to your desired position.

DISCLAIMER: Whilst every effort has been made to ensure colour accuracy, due to the limitations of colour printing, please refer to product samples for colour matching. Product dimensions are for guidance only and may differ – please confirm details at time of ordering.

AutoMoto Roman Blind Made-to-Measure Motorised Cassette System

AutoMoto Motorised Kits include:

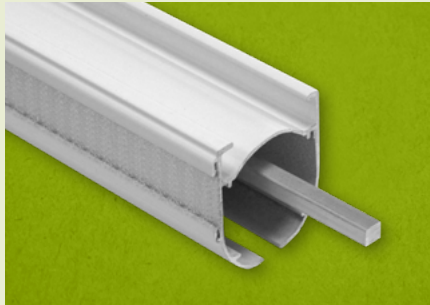

Headrail + 5mm Square Axle Bar + Loop Tape



Fast-Fit Tab Lock Cord Rollers with 3.5m Cord



Code: 17AMRC15

Handheld Multi-Channel Remote + Hanger



End Caps x1



Lever Brackets wall/ceiling fix



White Aluminium D-Section Bottom Weight Bar

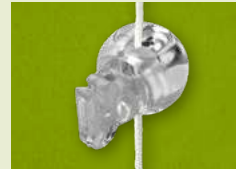

Child Safe Clip-in/Sew-in Adjustable Cord Stoppers



Code: 17AMMOTR

Motor & Receiver Kit
Pre-installed inside the Headrail

Power Supply Options

Mains Wire Powered Kit



240/12v Mains Power Adapter
Code: 17AMMPAW

Battery Powered Kit



USB-C Chargeable Battery with Clips
Code: 17AMSBPC



USB-A to USB-C Plug & Charger
Code: 17AMPCBP

Smart Home Option



Smart Home Connector Hub
Code: 16GAASHH

AutoMoto Roman Blind Made-to-Measure Motorised Cassette Kits

Components	Kit Sizes up to							
	60cm (24")	90cm (36")	120cm (48")	150cm (59")	180cm (71")	200cm (79")	250cm (98")	300cm (118")
Closed Cassette System Headrail	1 x 60cm	1 x 90cm	1 x 120cm	1 x 150cm	1 x 180cm	1 x 200cm	1 x 250cm	1 x 300cm
Aluminium Bottom Weight Bar D-Section	1 x 60cm	1 x 90cm	1 x 120cm	1 x 150cm	1 x 180cm	1 x 200cm	1 x 250cm	1 x 300cm
Square Axle Bars	1 x 60cm	1 x 90cm	1 x 120cm	1 x 150cm	1 x 180cm	1 x 200cm	1 x 250cm	1 x 300cm
20mm Loop Tape	1 x 60cm	1 x 90cm	1 x 120cm	1 x 150cm	1 x 180cm	1 x 200cm	1 x 250cm	1 x 300cm
End Cap [†]	2	2	2	2	2	2	2	2
12v DC Motor	1	1	1	1	1	1	1	1
Motor Mounting Inserts	2	2	2	2	2	2	2	2
Shaft Adapters	2	2	2	2	2	2	2	2
Fast-Fit Tab-Lock Cord Rollers Inc 3.5m cord	2	3	3	4	5	5	6	7
Clip-In Adjustable Cord Stoppers	2	3	3	4	5	5	6	7
Lever Brackets (face or ceiling fix)	2	2	3	3	4	4	4	6
Multi-Channel Remote (inc Battery)	1	1	1	1	1	1	1	1
AutoMoto Mains Wire Powered Kit Code*	17AM-WM060	17AM-WM090	17AM-WM120	17AM-WM150	17AM-WM180	17AM-WM200	17AM-WM250	17AM-WM300
AutoMoto Battery Powered Kit Code*	17AM-BM060	17AM-BM090	17AM-BM120	17AM-BM150	17AM-BM180	17AM-BM200	17AM-BM250	17AM-BM300

Packed: 1 px/Outer 10 Min Qty: 1

Fitting Instructions, Safety notice and Safety label included in every kit.

[†] Note: If purchasing a motorised kit for self assembly, the chain and chain house will not be required. Please order an extra end cap for this.

*Wired Power Supply Kits include a 240/12v Mains Power Adapter. Battery Powered Kits include a USB-C Chargeable Battery with Clips + USB-A to USB-C Plug & Charger

Orders must be placed in writing with size specified in mm. For alternative control options, requirements must be specified including type of control, number of blinds, sizes and weight of blinds and whether group switched or individually controlled. Feel free to contact us to discuss your requirements. Accessories images shown may differ subject to specification.

DISCLAIMER: Whilst every effort has been made to ensure colour accuracy, due to the limitations of colour printing, please refer to product samples for colour matching. Product dimensions are for guidance only and may differ – please confirm details at time of ordering.



Roman Blind Cassette System Workroom Kit

FAST»»FIT
TAB-LOCK CORD ROLLER

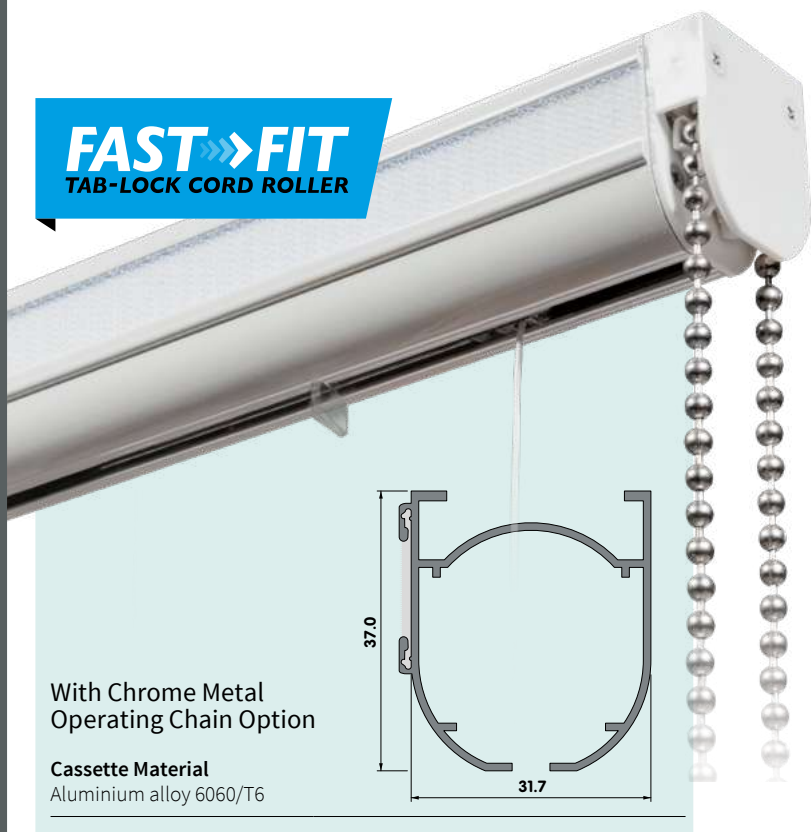

With Chrome Metal Operating Chain Option

Cassette Material
Aluminium alloy 6060/T6

Key Features:



IN-STOCK DELIVERY



MADE TO MEASURE



KITS AVAILABLE

Ideal for use in:



HOMES & DOMESTIC



OFFICES & HOTELS



CHILD SAFE APPROVED



With White Plastic Operating Chain Option

Cassette Material
Aluminium alloy 6060/T6

A fully enclosed Roman Blind lift-rail system available in contract component form or as a pre-packed kit – with made-to-measure options also available.

Easy to cut to size required width – drop cutting not required as the cord winds to any position – the pre-assembled product can be an essential time-saver for the professional fitter – ready assembled and ready corded.

Kits available including Tape and Roman Bars. Kits can be adjusted to special request to include cord adjusters, to exclude bottom bar, to swap bracket style and to swap chain guide gearing.

All Renaissance Closed Cassette Kits now include:

Clip-In Adjustable Cord Stoppers



All Closed Cassette System Kits are compliant to BS EN 3120:2009+A1:2014 Child Safety Standards.

FAST»»FIT
TAB-LOCK CORD ROLLER

The uniquely designed Fast-Fit Tab Lock Cord Roller from Renaissance with amazing time-saving features now available in Workroom kits!



NO SCREWS REQUIRED



AUTO-LOCATE

The uniquely designed chamfered mechanism automatically adjusts to fit the headrail axle bar.



TAB-LOCK

To securely lock the roller in place simply twist the Easy-Lock Tab 90° in either direction.



QUICK ADJUST

So simple to adjust – just twist the tab and slide in either direction to your desired position.

DISCLAIMER: Whilst every effort has been made to ensure colour accuracy, due to the limitations of colour printing, please refer to product samples for colour matching. Product dimensions are for guidance only and may differ – please confirm details at time of ordering.

Roman Blind Cassette System Workroom Kit

Kits include:

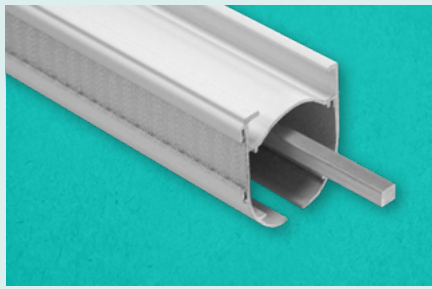

Headrail + 5mm Square Axle Bar + Loop Tape



Fast-Fit Tab Lock Cord Rollers with 3.5m Cord

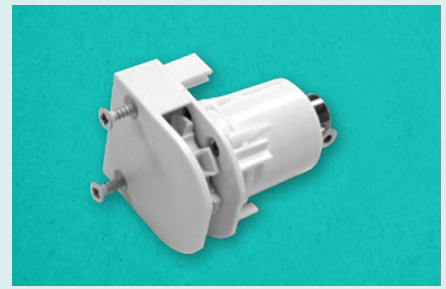

Workroom Kit Chain Housing 1:4 Ratio



End Cap



Lever Brackets wall/ceiling fix



White Aluminium D-Section Bottom Weight Bar

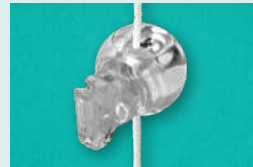

Child Safe Clip-in/Sew-in Adjustable Cord Stoppers



Child Safety P-Clip Includes Safety Warning Labels

Roman Blind Cassette System Workroom Kits

Components	Kit Sizes							
	60cm (24")	90cm (36")	120cm (48")	150cm (59")	180cm (71")	200cm (79")	250cm (98")	300cm (118")
Closed Cassette System Headrail	1 x 60cm	1 x 90cm	1 x 120cm	1 x 150cm	1 x 180cm	1 x 200cm	1 x 250cm	1 x 300cm
Aluminium Bottom Weight Bar D-Section	1 x 60cm	1 x 90cm	1 x 120cm	1 x 150cm	1 x 180cm	1 x 200cm	1 x 250cm	1 x 300cm
Square Axle Bar	1 x 60cm	1 x 90cm	1 x 120cm	1 x 150cm	1 x 180cm	1 x 200cm	1 x 250cm	1 x 300cm
20mm Loop Tape	1 x 60cm	1 x 90cm	1 x 120cm	1 x 150cm	1 x 180cm	1 x 200cm	1 x 250cm	1 x 300cm
End Cap	1	1	1	1	1	1	1	1
1:4 Closed Cassette System Chain Guide	1	1	1	1	1	1	1	1
100cm Continuous Chain*	1	1	1	1	1	1	1	1
Fast-Fit Tab-Lock Cord Rollers Inc 3.5m cord	2	3	3	4	5	5	6	7
Clip-In Adjustable Cord Stoppers	2	3	3	4	5	5	6	7
Lever Brackets (wall or ceiling fix)	2	2	3	3	4	4	4	6
Safety Cord Guide (P-Clip)	1	1	1	1	1	1	1	1
Child Safe Awareness Safety Labels	1	1	1	1	1	1	1	1
Workroom Kit + Chrome Chain Code*	17CL4SK060	17CL4SK090	17CL4SK120	17CL4SK150	17CL4SK180	17CL4SK200	17CL4SK250	17CL4SK300
Workroom Kit + Plastic Chain Code*	17CL4PK060	17CL4PK090	17CL4PK120	17CL4PK150	17CL4PK180	17CL4PK200	17CL4PK250	17CL4PK300
Made-to-Measure Kit + Chrome Chain**	17CL4SM060	17CL4SM090	17CL4SM120	17CL4SM150	17CL4SM180	17CL4SM200	17CL4SM250	17CL4SM300
Made-to-Measure Kit + Plastic Chain**	17CL4PM060	17CL4SP090	17CL4SP120	17CL4SP150	17CL4SP180	17CL4SP200	17CL4SP250	17CL4SP300

Packed: 1 px/Outer 10

Min Qty: 1

Fitting Instructions, Safety notice & safety label included in every kit.

*Kit Operation Chain Options



Chrome Metal Chain



White Plastic Spaced Chain

Kit Alternative Components Swap/Upgrade



Chain Housing 1:2 Ratio

Code: 17CQCH2- Packed 10



Click/Spring Release Bracket

Code: 17CLCB1W Packed 100



Sew-in Adjustable Cord Stoppers

Code: 58WACCCC Packed 100

Also Available from Renaissance

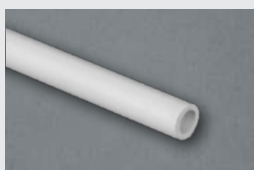

Hollow Plastic Bars



Wood Dowel Bars



Fibre Glass Rods Kits



Roman Blind Tape

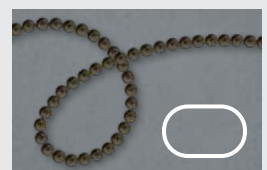

Alternative Operating Chains

Various colour and size available

DISCLAIMER: Whilst every effort has been made to ensure colour accuracy, due to the limitations of colour printing, please refer to product samples for colour matching. Product dimensions are for guidance only and may differ – please confirm details at time of ordering.



RENAISSANCE

TEL 0113 250 4499

• EMAIL SALES@RCA-UK.COM

• VISIT RCA-UK.COM

197

Roman Blind Cassette System Safe-Release™ Kit

FAST»»FIT
TAB-LOCK CORD ROLLER

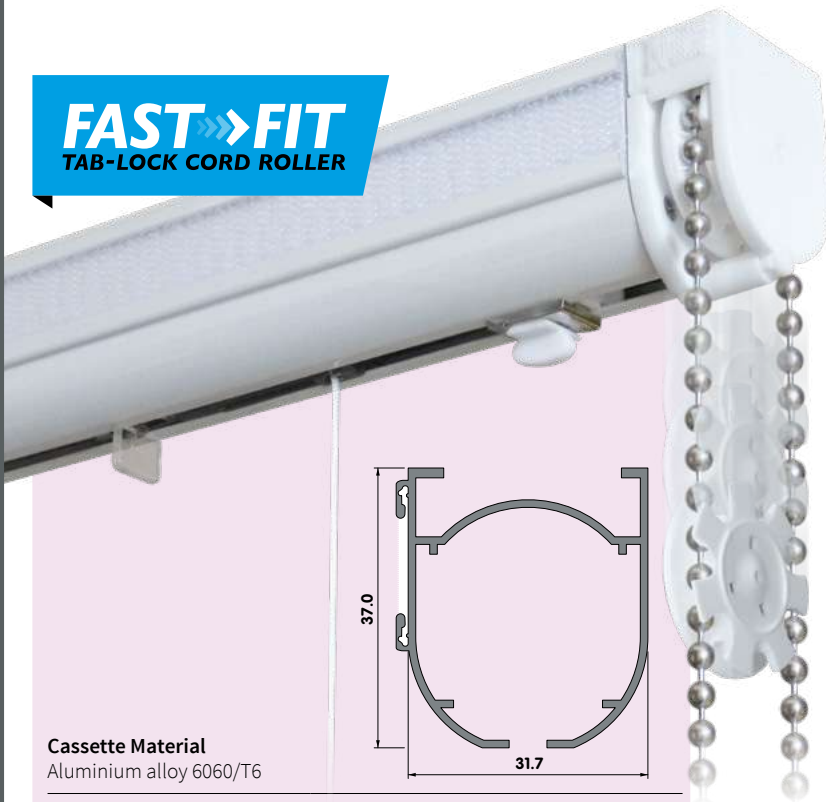

Cassette Material
Aluminium alloy 6060/T6

Key Features:



IN-STOCK DELIVERY

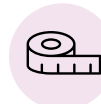

MADE TO MEASURE



KITS AVAILABLE



CHAIN RELEASE

Ideal for use in:



HOMES & DOMESTIC



OFFICES & HOTELS



CHILD SAFE APPROVED

All Renaissance Closed Cassette Kits now include:

Clip-In Adjustable Cord Stoppers



How it works Safe-Release™

The specially designed Spring-Wheel will release from the Safe-Release Gear Housing together with the chain to meet the 6kg testing requirement for Child Safe regulations.

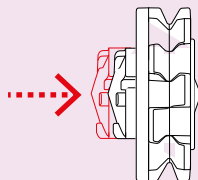

To reconnect just re-align the Spring-Wheel & Chain up with the Safe-Release Housing and push back into place from below.

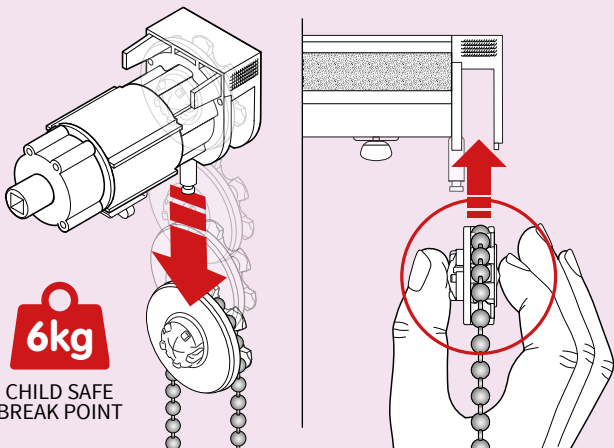

All Closed Cassette System Kits are compliant to BS EN 3120:2009+A1:2014 Child Safety Standards.

FAST»»FIT
TAB-LOCK CORD ROLLER

The uniquely designed Fast-Fit Tab Lock Cord Roller from Renaissance with amazing time-saving features now available in Safe-Release kits!



NO SCREWS REQUIRED



AUTO-LOCATE

The uniquely designed chamfered mechanism automatically adjusts to fit the headrail axle bar.



TAB-LOCK

To securely lock the roller in place simply twist the Easy-Lock Tab 90° in either direction.



QUICK ADJUST

So simple to adjust – just twist the tab and slide in either direction to your desired position.

DISCLAIMER: Whilst every effort has been made to ensure colour accuracy, due to the limitations of colour printing, please refer to product samples for colour matching. Product dimensions are for guidance only and may differ – please confirm details at time of ordering.



Roman Blind Cassette System Safe-Release™ Kit

Kits include:

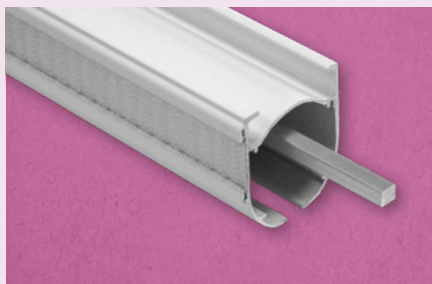

Headrail + 5mm Square Axle Bar + Loop Tape



Fast-Fit Tab Lock Cord Rollers with 3.5m Cord

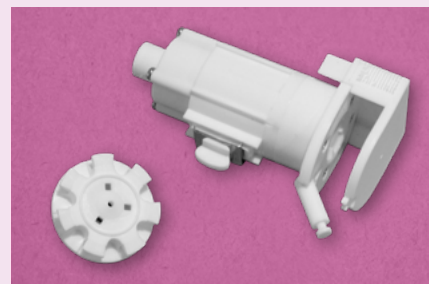

Safe-Release™ Chain Housing 1:4 Ratio



End Cap



Lever Brackets wall/ceiling fix



White Aluminium D-Section Bottom Weight Bar

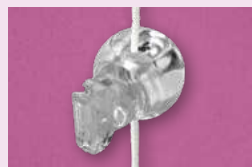

Child Safe Clip-in/Sew-in Adjustable Cord Stoppers



20mm Loop Tape (Sew-on)

Roman Blind Cassette System Safe-Release™ Workroom Kits

Components	Kit Sizes							
	60cm (24")	90cm (36")	120cm (48")	150cm (59")	180cm (71")	200cm (79")	250cm (98")	300cm (118")
Closed Cassette System Headrail	1 x 60cm	1 x 90cm	1 x 120cm	1 x 150cm	1 x 180cm	1 x 200cm	1 x 250cm	1 x 300cm
Aluminium Bottom Weight Bar D-Section	1 x 60cm	1 x 90cm	1 x 120cm	1 x 150cm	1 x 180cm	1 x 200cm	1 x 250cm	1 x 300cm
Square Axle Bar	1 x 60cm	1 x 90cm	1 x 120cm	1 x 150cm	1 x 180cm	1 x 200cm	1 x 250cm	1 x 300cm
20mm Loop Tape	1 x 60cm	1 x 90cm	1 x 120cm	1 x 150cm	1 x 180cm	1 x 200cm	1 x 250cm	1 x 300cm
End Cap	1	1	1	1	1	1	1	1
Safe-Release™ Chain Housing 1:4 Ratio	1	1	1	1	1	1	1	1
100cm Continuous Chain*	1	1	1	1	1	1	1	1
Fast-Fit Tab-Lock Cord Rollers Inc 3.5m cord	2	3	3	4	5	5	6	7
Clip-In Adjustable Cord Stoppers	2	3	3	4	5	5	6	7
Lever Brackets (wall or ceiling fix)	2	2	3	3	4	4	4	6
Child Safe Awareness Safety Labels	1	1	1	1	1	1	1	1
Safe-Release™ Kit + Chrome Chain Code*	17CW4SK060	17CW4SK090	17CW4SK120	17CW4SK150	17CW4SK180	17CW4SK200	17CW4SK250	17CW4SK300
Safe-Release™ Kit + Plastic Chain Code*	17CW4PK060	17CW4PK090	17CW4PK120	17CW4PK150	17CW4PK180	17CW4PK200	17CW4PK250	17CW4PK300
Safe-Release™ M2M Kit + Chrome Chain**	17CW4SM060	17CW4SM090	17CW4SM120	17CW4SM150	17CW4SM180	17CW4SM200	17CW4SM250	17CW4SM300
Safe-Release™ M2M Kit + Plastic Chain**	17CW4PM060	17CW4PM090	17CW4PM120	17CW4PM150	17CW4PM180	17CW4PM200	17CW4PM250	17CW4PM300

Packed: 1 px/Outer 10

Min Qty: 1

Fitting Instructions, Safety notice & safety label included in every kit.

* Alternative Chains can be included for the additional chain cost – see page 201 for full detail on Chains available. ** Made-to-measure includes a cut to your required size.

*Kit Operation Chain Options



Chrome Metal Chain



White Plastic Spaced Chain

Kit Alternative Components Swap/Upgrade

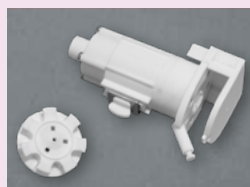

Safe-Release Housing 1:1 Ratio
Code: 17CWCH1- Packed 10



Click/Spring Release Bracket
Code: 17CLCB1W Packed 100



Sew-in Adjustable Cord Stoppers
Code: 58WACCCC Packed 100

Also Available from Renaissance

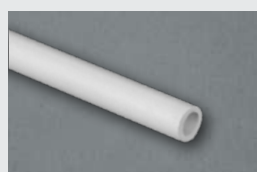

Hollow Plastic Bars



Wood Dowel Bars



Fibre Glass Rods Kits



Roman Blind Tape

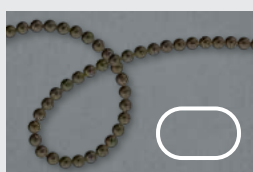

Alternative Operating Chains
Various colour and size available

DISCLAIMER: Whilst every effort has been made to ensure colour accuracy, due to the limitations of colour printing, please refer to product samples for colour matching. Product dimensions are for guidance only and may differ – please confirm details at time of ordering.

Roman Blind Closed Cassette Components

Closed Cassette Headrail + Components + Brackets

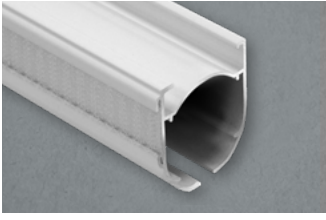

Closed Cassette System Headrail
 Size: 5.8m Code: 17CLHR58
 Packed: 10 Lengths Min Qty: 10



5mm Square Axle Bar
 Size: 2.9m Code: 17HVDAX3
 Size: 5.8m Code: 17HVDAX6
 Packed: 10 Lengths Min Qty: 10

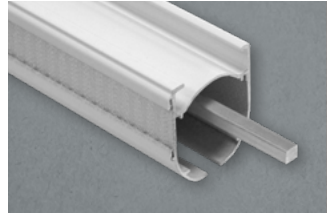

Closed Cassette System Headrail + 5mm Square Axle Bar
 Size: 5.8m Code: 17CLHRAX
 Packed: 10 Lengths Min Qty: 10

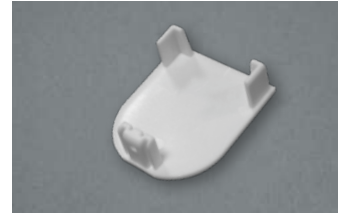

Closed Cassette End Cap
 Code: 17CLEC1W
 Packed: 10 Lengths Min Qty: 10

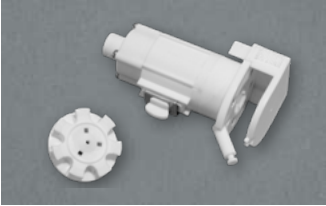

Safe-Release™ Housing
 Chain Control: 1:1 Code: 17CWCH1-
 Chain Control: 1:4 Code: 17CWCH4-
 Packed: 10 Min Qty: 10



Safe-Drop Housing
 Chain Control: 1:4 Code: 17CDCH4-
 Packed: 10 Min Qty: 10

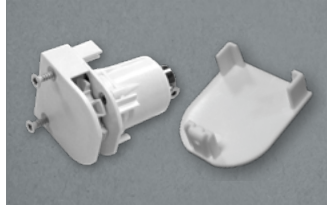

Workroom Kit Chain Housing + End Cap
 Chain Control: 1:2 Code: 17CQCH2-
 Chain Control: 1:4 Code: 17CQCH4-
 Packed: 10 Min Qty: 10

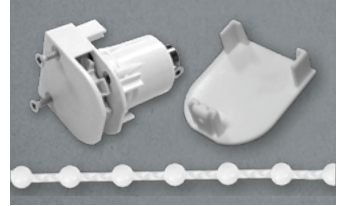

Workroom Kit Chain Housing + End Cap + 100cm Chain
 Chain Control: 1:2 Code: 17CQCH2C
 Chain Control: 1:4 Code: 17CQCH4C
 Packed: 10 Min Qty: 10

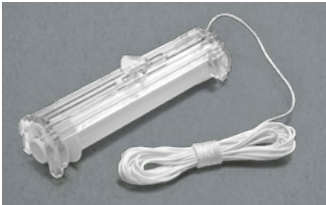

Fast-Fit Tab Lock Cord Roller 3.5m Cord
 Code: 17CTCR35
 Packed: 10 Min Qty: 10



Lever Brackets wall/ceiling fix
 Code: 17CLSB1W
 Packed: 100 Min Qty: 10

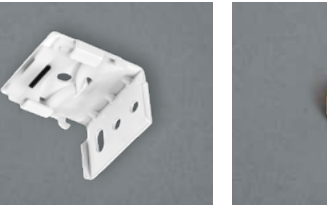

Click/Spring Release Bracket
 Code: 17CLCB1W
 Packed: 100 Min Qty: 10

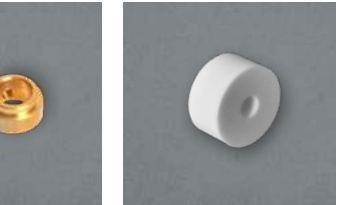

Adjustable Stopper
 Brass Code: 17CSST1B
 Packed: 100 Min Qty: 10

10mm Track Spacer
 Code: 16HSSPCW
 Packed: 100 Min Qty: 100

L-Extension Brackets

L-Extension Brackets can be used with tracks or blinds to increase the projection from the wall to desired length. Prevents curtains/blinds catching on protruding door or window handles.



3cm L-Extension Bracket
 Code: 16LB031W
 Packed: 10 Min Qty: 10



9cm L-Extension Bracket
 Code: 16LB091W
 Packed: 10 Min Qty: 10

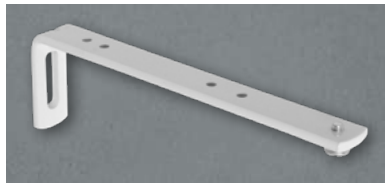

14cm L-Extension Bracket
 Code: 16LB141W
 Packed: 10 Min Qty: 10



L-Extension Bracket Cover One Size fits all
 White Code: 16LBCOWW
 Packed: 10 Min Qty: 10

Hook & Loop Tapes

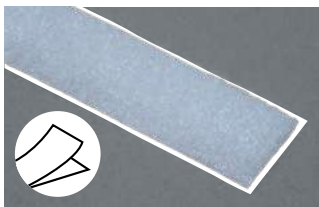

Hook Tape Self Adhesive
 White 20mm (¾") Code: 53C2AHRW
 White 25mm (1") Code: 53C1AHRW
 White 50mm (2") Code: 53C5AHRW
 Black 20mm (¾") Code: 53C2AHRK
 Black 50mm (2") Code: 53C5AHRK
 Packed: 25m Roll

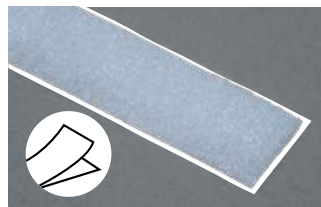

Loop Tape Self Adhesive
 White 20mm (¾") Code: 53C2ALRW
 White 25mm (1") Code: 53C1ALRW
 White 50mm (2") Code: 53C5ALRW
 Black 20mm (¾") Code: 53C2ALRK
 Black 50mm (2") Code: 53C5ALRK
 Packed: 25m Roll

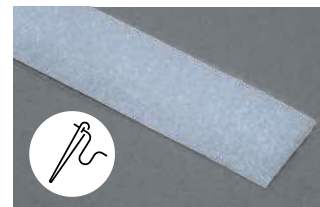

Hook Tape Sew On
 White 20mm (¾") Code: 53C2SHRW
 White 25mm (1") Code: 53C1SHRW
 White 50mm (2") Code: 53C5SHRW
 Black 20mm (¾") Code: 53C2SHRK
 Black 50mm (2") Code: 53C5SHRK
 Packed: 25m Roll

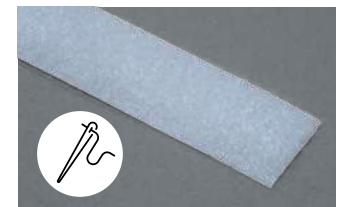

Loop Tape Sew On
 White 20mm (¾") Code: 53C2SLRW
 White 25mm (1") Code: 53C1SLRW
 White 50mm (2") Code: 53C5SLRW
 Black 20mm (¾") Code: 53C2SLRK
 Black 50mm (2") Code: 53C5SLRK
 Packed: 25m Roll

DISCLAIMER: Whilst every effort has been made to ensure colour accuracy, due to the limitations of colour printing, please refer to product samples for colour matching. Product dimensions are for guidance only and may differ – please confirm details at time of ordering.

Roman Blind Accessories

Operating Chains – Metal



Metal Continuous Chain Chrome

- Size: **50cm** Code: 17CC05MS
- Size: **75cm** Code: 17CC07MS
- Size: **100cm** Code: 17CC10MS
- Size: **125cm** Code: 17CC12MS
- Size: **150cm** Code: 17CC15MS
- Size: **175cm** Code: 17CC17MS
- Size: **200cm** Code: 17CC20MS
- Size: **250cm** Code: 17CC25MS

Packed: 10 Min Qty: 10



Metal Continuous Chain Brass

- Size: **50cm** Code: 17CC05MB
- Size: **75cm** Code: 17CC07MB
- Size: **100cm** Code: 17CC10MB
- Size: **125cm** Code: 17CC12MB
- Size: **150cm** Code: 17CC15MB
- Size: **175cm** Code: 17CC17MB
- Size: **200cm** Code: 17CC20MB
- Size: **250cm** Code: 17CC25MB

Packed: 10 Min Qty: 10



Metal Continuous Chain Antique Brass

- Size: **50cm** Code: 17CC05MA
- Size: **75cm** Code: 17CC07MA
- Size: **100cm** Code: 17CC10MA
- Size: **125cm** Code: 17CC12MA
- Size: **150cm** Code: 17CC15MA
- Size: **175cm** Code: 17CC17MA
- Size: **200cm** Code: 17CC20MA
- Size: **250cm** Code: 17CC25MA

Packed: 10 Min Qty: 10



Metal Continuous Chain Black Nickel

- Size: **50cm** Code: 17CC05MI
- Size: **75cm** Code: 17CC07MI
- Size: **100cm** Code: 17CC10MI
- Size: **125cm** Code: 17CC12MI
- Size: **150cm** Code: 17CC15MI
- Size: **175cm** Code: 17CC17MI
- Size: **200cm** Code: 17CC20MI
- Size: **250cm** Code: 17CC25MI

Packed: 10 Min Qty: 10

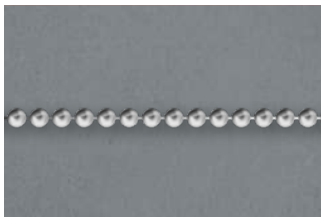

Metal Chain Length per metre

- **Chrome** Code: 17CHMDRS
- **Brass** Code: 17CHMDRB
- **Antique Brass** Code: 17CHMDRA
- **Black Nickel** Code: 17CHMDRI

Packed: 150m Roll Min Qty: 10m*

*Cuts incur a surcharge



Metal Chain Connector

- **Chrome** Code: 17CHOCs
- **Brass** Code: 17CHOCB
- **Antique Brass** Code: 17CHOCA
- **Black Nickel** Code: 17CHOCI

Packed: 100 Min Qty: 100



Chain Connector Pliers

Packed: 1 Code: 17CHCTOOL

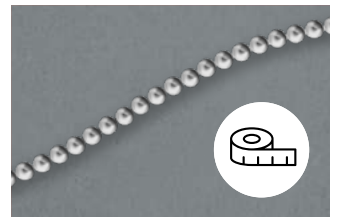

Made-to-Measure Chain Service Charge

- **Chrome** Code: 17CCMTMS
- **Brass** Code: 17CCMTMB
- **Antique Brass** Code: 17CCMTMA
- **Black Nickel** Code: 17CCMTMI

Operating Chains – Plastic



Plastic Continuous Chain Double Ball

- Drop: 100cm** Code: 17CC10DW
- Drop: 150cm** Code: 17CC15DW
- Drop: 200cm** Code: 17CC20DW

Packed: 10 Min Qty: 10

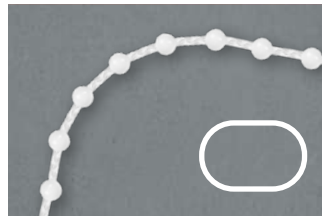

Plastic Continuous Chain Spaced Ball

- Drop: 50cm** Code: 17CC050W
- Drop: 75cm** Code: 17CC075W
- Drop: 100cm** Code: 17CC100W
- Drop: 150cm** Code: 17CC150W
- Drop: 200cm** Code: 17CC200W

Packed: 10 Min Qty: 10

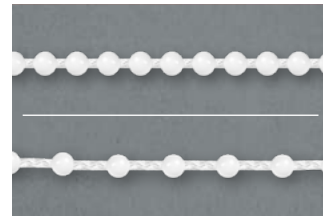

Roll of Plastic Chain

- Double Ball** Code: 17CHPDRW
- Spaced Ball** Code: 17CHPSRW

Packed: 150m Min Qty: 10m*

*Cuts incur a surcharge



Plastic Chain Connector

Code: 17CHCOW
Packed: 100 Min Qty: 100

Bottom Weight Bars

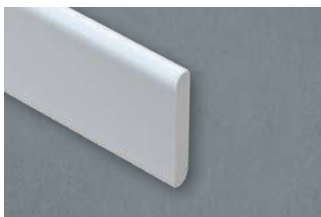

Aluminium Bottom Weight Bar O-Section 20mm x 3mm

- **Silver 300cm** Code: 17HVBWB3N
- **Silver 600cm** Code: 17HVBWB6N

Packed: 10 Min Qty: 10



Aluminium Bottom Weight Bar O-Section 20mm x 3mm

- **White 300cm** Code: 17HVBWB3W
- **White 600cm** Code: 17HVBWB6W

Packed: 10 Min Qty: 10



Aluminium Bottom Weight Bar D-Section 20mm x 4mm

- **White 300cm** Code: 17HVDW3W
- **White 600cm** Code: 17HVDW6W

Packed: 10 Min Qty: 10



Plastic Bottom Weight Bar Oval 25mm x 8mm

- **White** Code: 17BWPL3W

Packed: 10 Min Qty: 10

DISCLAIMER: Whilst every effort has been made to ensure colour accuracy, due to the limitations of colour printing, please refer to product samples for colour matching. Product dimensions are for guidance only and may differ – please confirm details at time of ordering.



Roman Blind Accessories

Roman Blind Bars

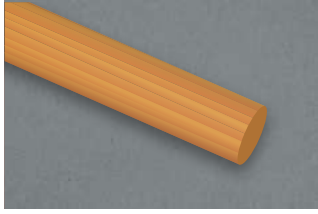

Round Wooden Dowel Ø 9mm
Length: 2.4m Packed: 18 Code: 17HVD924

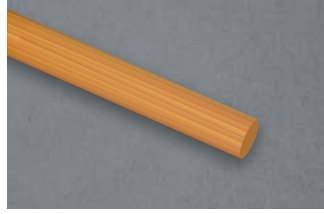

Round Wooden Dowel Ø 6mm
Length: 2.4m Packed: 18 Code: 17HVD624

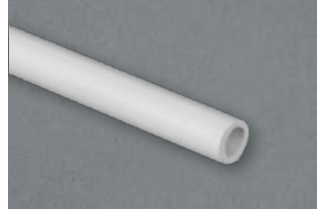

Hollow Plastic Bar Ø 6mm
Length: 3.0m Packed: 10 Code: 17HVRP3W

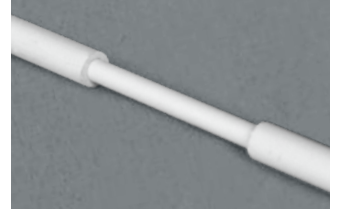

Hollow Plastic Bar Joiner
Packed: 100 Code: 17HVRPJW



Round Fibre Glass Bars Ø 4mm
300cm Packed: 10 Code: 17HVFB3W
400cm Packed: 20 Code: 17HVFB4W
500cm Packed: 20 Code: 17HVFB5W
600cm Packed: 50 Code: 17HVFB6W

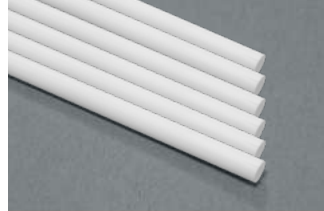

Round Fibre Glass Bar Kits x6 bars
60cm (24") Code: 17HVFB06
90cm (36") Code: 17HVFB09
120cm (48") Code: 17HVFB12
150cm (59") Code: 17HVFB15
200cm (79") Code: 17HVFB20
250cm (99") Code: 17HVFB25
300cm (118") Code: 17HVFB30



Fibre Glass Bar Cutting Tool
Packed: 1 Code: 17HVFCU



Fibre Glass Bar Caps
Packed: 100 Code: 17FBECCW

Roman Blind Tapes Slotted



Spooled Roman Blind Tape 20mm (3/4") White
Packed: 100m roll Code: 50TRBWPC
Packed: 1000m Lapped Code: 50TRBWPK

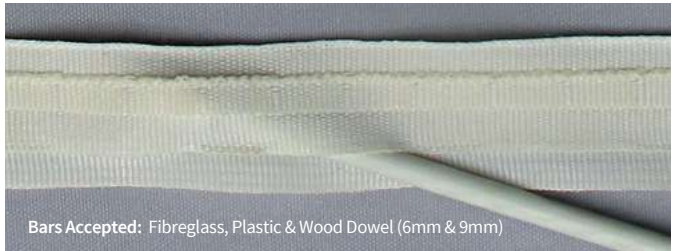

Spooled Roman Blind Tape 20mm (3/4") Cream
Packed: 100m roll Code: 50TRBCPC
Packed: 1000m Lapped Code: 50TRBCPK



Roman Blind Tape For Voiles 18mm (3/4") Transparent
Packed: 200m roll Code: 51TRBTRR



Boxed Roman Blind Tape 26mm (1") Cream
Packed: 100m roll Code: 50TRBCSC

Roman Blind Tapes Non-Slotted



Select Roman Blind Tape 20mm (3/4") White
Packed: 100m roll Code: 50TRBWSC



Select Roman Blind Tape 20mm (3/4") Cream
Packed: 100m roll Code: 50TRBCSC

DISCLAIMER: Whilst every effort has been made to ensure colour accuracy, due to the limitations of colour printing, please refer to product samples for colour matching. Product dimensions are for guidance only and may differ – please confirm details at time of ordering.

CHILD SAFETY

When it comes to ligatures, Child Safety is paramount. That's why we supply industry approved Child Safety devices on all our cord and chain operated Tracks & Blinds. **You're in safe hands with Renaissance.**



Child Safety Devices For Rear Cords



Sew-In Adjustable Cord Stopper

Packed: 100 Code: 58WACSCC
Packed: 1000 Code: 58WACKCK

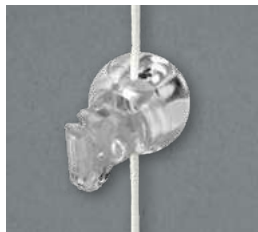

Clip-in/Sew-In Adjustable Cord Stopper

Packed: 100 Code: 58WACCCC
Packed: 1000 Code: 58WACCCK



Cord Breakaway for Multiple Cords

Enables cords to break at 6kg
Packed: 100 Code: 58CSCCCC



Rear Sew-In Cord Release

Packed: 100 Code: 58CSSRCT



Rear Sew-In Cord Break

Packed: 100 Code: 58CSCBCT



Rear Clip-In Cord Release

Packed: 100 Code: 58CSBACT
Packed: 1000 Code: 58CSBAKT

Child Safety Devices For Chains



Roman Blind Chain Break

Packed: 100 Code: 58CSCHCT



Safety Box Double Chain

Packed: 100 Code: 58WASBDB
Min Qty: 10



Safety Box Single Chain

Packed: 100 Code: 58WASBSG
Min Qty: 10

Cleat Hooks and Cord Pulls

See page 219 for our metal Cleat Hooks and page 220 for our full range of Cord Pulls in various colour finishes.

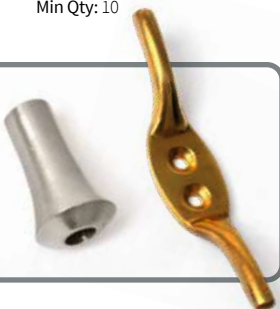

Child Safety Chain Tensioners & P-Clip



Plastic Chain/Cord Tensioner

Packed: 10 Code: 18CTCTPW



Metal Chain/Cord Tensioner

Packed: 10 Code: 18CTCTMW



Clear 'P-Clip' Safety Chain/Cord Guide

Packed: 100 Code: 58WASCCL

Child Safety Warning Labels



Safety Warning Tag

Packed: 100 Code: 58WASTST
Min Qty: 10



Safety Warning Labels

Code: 58WASWLA
Packed: Roll of 100

DISCLAIMER: Whilst every effort has been made to ensure colour accuracy, due to the limitations of colour printing, please refer to product samples for colour matching. Product dimensions are for guidance only and may differ – please confirm details at time of ordering.



AVAILABLE IN ALL RENAISSANCE CLOSED CASSETTE KITS AS STANDARD!

FAST FIT

TAB-LOCK CORD ROLLER



AUTO-LOCATE

The uniquely designed chamfered inner mechanism will automatically adjust to fit the headrail axle bar.

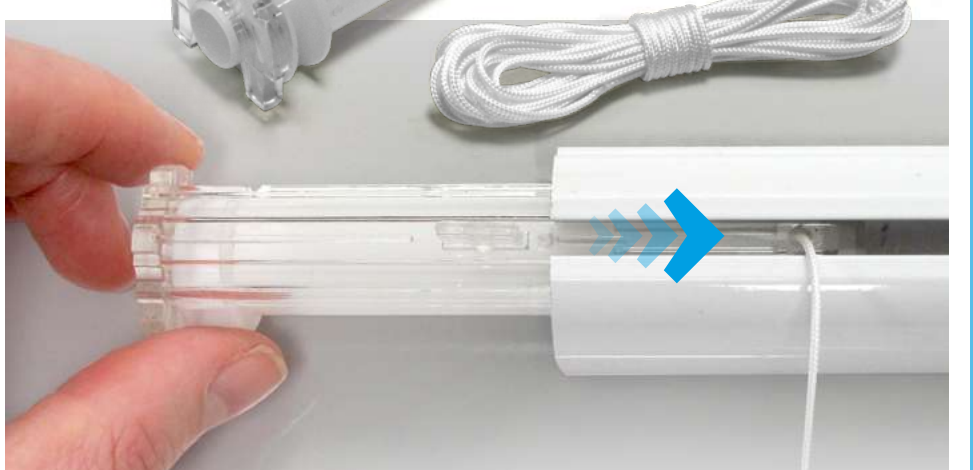

TAB-LOCK

To lock the roller in place simply twist the Easy-Lock Tab 90° in either direction. Simple as that!



**NO SCREWS
REQUIRED**



QUICK ADJUST

It's so simple to adjust – just twist the tab and slide in either direction to reach your desired position.

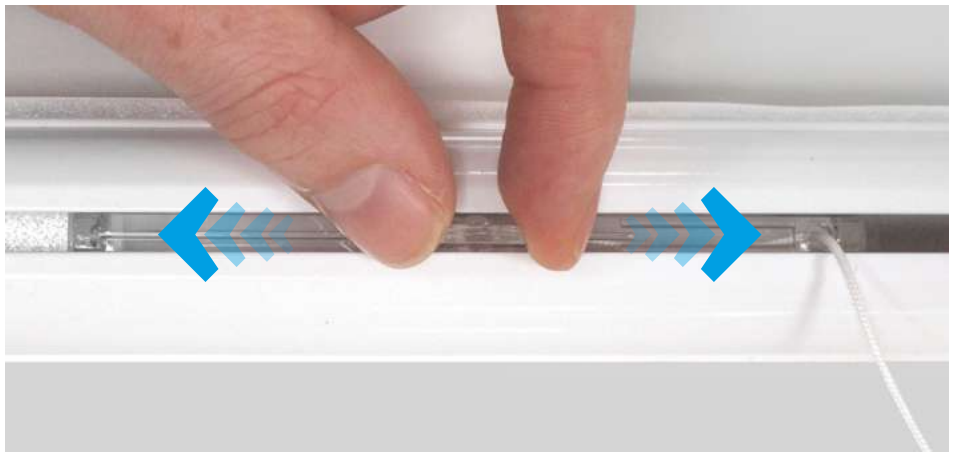

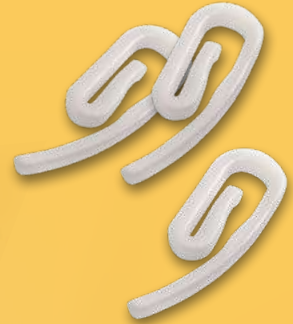

*Essentials*TM

WORKROOM ACCESSORIES

CONTENTS

Eyelets • Eyelet Tooling • Eyelet Tapes	206–210
Curtain Tapes	211–213
SurgeWave System Tape & Accessories	213
Blind Tapes • Cords & Cord Accessories	214
Hook & Loop Tapes	215
Lead Weights • Lead Weight Tapes	215
Spray & Solutions	215
Stiffeners, Fusibles & Buckrams	216
Curtain Rings	216
Curtain Hooks	217
S-Hooks & Sundries	218
Pelmet Brackets	218
Roller Blind Accessories	218
Vertical Blind Accessories	218
Tieback Hooks & Cleat Hooks	219
Cord Pulls	220
Branded Curtain Track Compatible Accessories	220
Self Adhesive Tieback Hooks	221
Twist Tension Rods & Shower Rails	221
Curtain Wire & Accessories	221
Child Safety Products	222

Eyelets

Metal Eyelets

Metal eyelets offered in 5 sizes, these are ideal for any weight of curtains with a large flange allowing for thick, interlined headings.

The tooling compresses the eyelet to ensure the fabric does not move and the metal rolls to leave a clean finished edge without sharp edges.

See matrix below for colour availability.



25mm Eyelets

Suitable for up to 19mm diameter poles

ID 25mm
OD 44mm

Packed: 100
25mm Luxury: 45EYB2CX



40mm Metal Eyelets

Suitable for up to 30mm diameter poles

ID 40mm
OD 63mm

40mm Luxury Code: 45EYB4CX
40mm Contract 100: 45EYM4CX
40mm Contract 1000: 45EYM4KX



50mm Metal Eyelets

Suitable for up to 40mm diameter poles

ID 50mm
OD 80mm

Packed: 100
50mm Luxury Code: 45EYB5CX



66mm Luxury Metal Eyelets

Suitable for up to 50mm diameter poles

ID 66mm
OD 97mm

Packed: 100
66mm Luxury Code: 45EYB6CX

Colour Options: Replace X in order code for your chosen colour letter ref – see matrix below for colour availability



B

Plain Brass †



S

Chrome



N

Nickel



T

Satin Nickel



O

Oxy Black



K

Gloss Black Powder Coated †

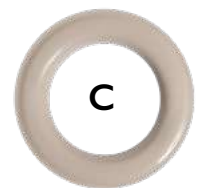

C

Cream †



A

Antique Brass



R

Antique Copper



I

Antique Nickel



M

Bright Gunmetal



Metal Eyelet Colour Availability

Colours	Metal Eyelet Sizes					
	10mm*	25mm Lux*	40mm	40mm Lux*	50mm Lux*	66mm Lux*
Plain Brass	✓	✓		✓	✓	✓
Chrome		✓			✓	✓
Nickel	✓		⊙	✓	✓	✓
Satin Nickel			⊙	✓	✓	✓
Oxy Black			⊙	✓	✓	✓
Antique Brass			⊙	✓	✓	✓
Antique Copper		✓	✓	✓	✓	✓
Antique Nickel		✓	✓	✓	✓	✓
Bright Gunmetal			✓	✓	✓	✓
Gloss Black				✓	✓	✓
Cream				✓		

* Brass Based Eyelets. † Luxury only colours. ⊙ = Available in bulk boxes of 1000

Also Available



10mm Metal Sail Eyelets

Ideal for roman blinds, shower curtains and decorative features on blinds.

ID 10mm
OD 17mm

Packed: 1000

Brass Code: 45EYM1KB
Nickel Code: 45EYM1KN



40mm Eyelet Liners

Improves the running of metal eyelets for a smoother and quieter action.

Packed: 100

Code: 45EYL4C

DISCLAIMER: Whilst every effort has been made to ensure colour accuracy, due to the limitations of colour printing, please refer to product samples for colour matching. Product dimensions are for guidance only and may differ – please confirm details at time of ordering.

1 Ton Eyelet Press

1 Ton Press for cutter use with plastic or metal eyelets and closing tooling for metal eyelets

- Accommodates all eyelet sizes up to 66mm diameter
- Incorporates a fabric guide and spacing guide for speed and accuracy
- Optional extras include work bench and combination tool for cutting and closing (for 25mm and 40mm eyelets)

Please note: Colour and design of press may vary between batches but capacity and quality will remain unchanged

1 Ton Press only	Code: 45EY0PRE
1 Ton Press + 25mm Combi-Tooling	Code: 45EY2KIT
1 Ton Press + 40mm Combi-Tooling	Code: 45EY4KIT
1 Ton Press + 50mm Tooling	Code: 45EY5KIT
1 Ton Press & 66mm Tooling	Code: 45EY6KIT
1 Ton Press & 25mm and 40mm Combi-Tooling and 66mm Tooling	Code: 45EYAKIT

V-Cutter tooling only for 1 Ton Press

Ideal for silk and thin fabrics (for closers please use Combi-Tool)

V-Cutters for 25mm	Code: 45EY2VCU
V-Cutters for 40mm	Code: 45EY24VCU

25mm Combi-Tooling Set	Code: 45EY2TOO
40mm Combi-Tooling Set	Code: 45EY4TOO
Allows for cutting & closing without changing tooling	

50mm Tooling Cutters and Closers Set	Code: 45EY5TOV
66mm Tooling Cutters and Closers Set	Code: 45EY6TOV

Spare Long Arm	Code: 45EY0ARM
Spare Measuring Guide	Code: 45EY0MES
Tubular Bench Powder coated, self-assembly	Code: 45EY0TAB

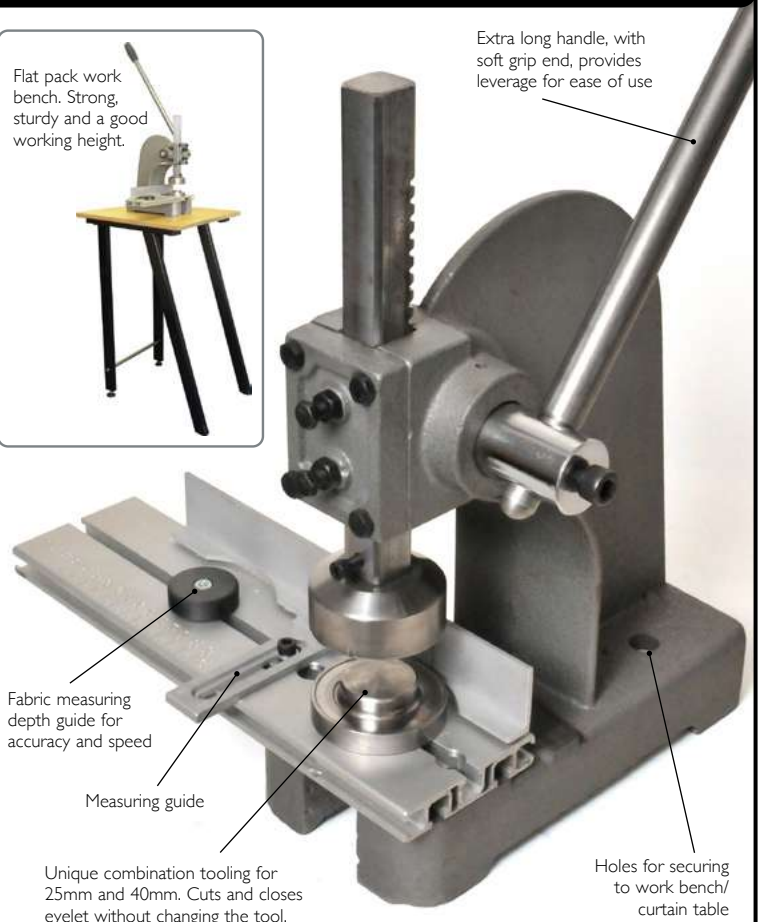
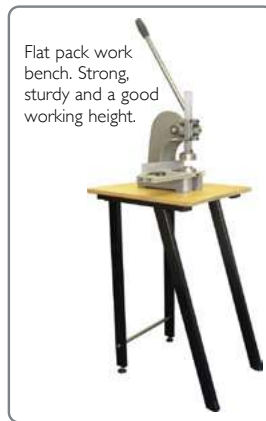

Pneumatic Eyelet Machine

Totally pneumatic operated. Will in one single action punch out a hole in the material whilst simultaneously setting the eyelet or grommet. Tooling Available for all types of Metal Eyelets

Features Include:

- Does not require any electrical connection
- Extremely simple to operate
- Sets sizes up to 66mm hole diameter
- Sets eyelets in a wide variety of materials including vinyl, plastic, canvas, cloth and leather
- Side & back stop for accurate placement of work
- An optional laser can be fitted as an alternative way of positioning material
- Foot operated pedal leaves both hands free
- Finger guard protection mechanism prevents

- operation when dies are obstructed
- Available with or without bench, or mounted on castors for moving around the floor/ table when working with very large pieces of material
- Compressor and installation included
- Additional tooling to be added (sold separate)

Technical Data

Height	480mm
Width	150mm
Depth	430mm
Throat Depth	150mm
Weight (without bench)	25kgs
Power Supply	Pneumatic
Maximum Size of Eyelet	66mm



1/2 Ton Press

1/2 Ton Press with Sail Eyelet Combi-Tooling
Code: 45EY1KIT

Sail Eyelet Combi-Tooling
Code: 45EY1TOO

Packed: Individually

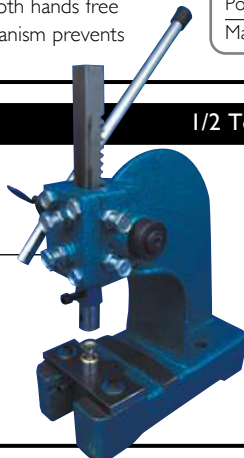

10mm Metal Sail Eyelets

Ideal for roman blinds, shower curtains and decorative features on blinds.

Colours Available:
Brass or Nickel finish

Packed Loose: Box 1000



Many other sizes and types of eyelets and tooling available.

Please provide us with your requirements



DISCLAIMER: Whilst every effort has been made to ensure colour accuracy, due to the limitations of colour printing, please refer to product samples for colour matching. Product dimensions are for guidance only and may differ – please confirm details at time of ordering.

Eyelets

Heavy Duty Plastic Eyelets

40mm & 55mm Heavy Duty Plastic Eyelets for thicker fabrics. Easy fix for speed, removable for washing or dry cleaning curtains, or for colour/design change.

Multi-uses for decoration on curtains, blinds, voiles, pelmets. Ideal for medium to heavyweight curtains, pelmets and interlined fabrics, no tape necessary.

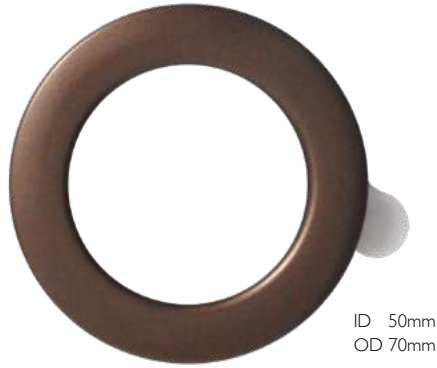

ID 50mm
OD 70mm

55mm Heavy Duty Plastic Eyelet

Punch hole of 55mm. Suitable for up to 40mm diameter poles.

Pre-packed: 10 px Code: 45EYH5DX

Colours: Replace X in order code for your chosen colour letter ref



ID 35mm
OD 55mm

40mm Heavy Duty Plastic Eyelet

Punch hole of 40mm. Suitable for up to 30mm diameter poles.

Pre-packed: 10 px Code: 45EYH4DX

Colours: Replace X in order code for your chosen colour letter ref



How it works: Step-by-Step Guide to Use

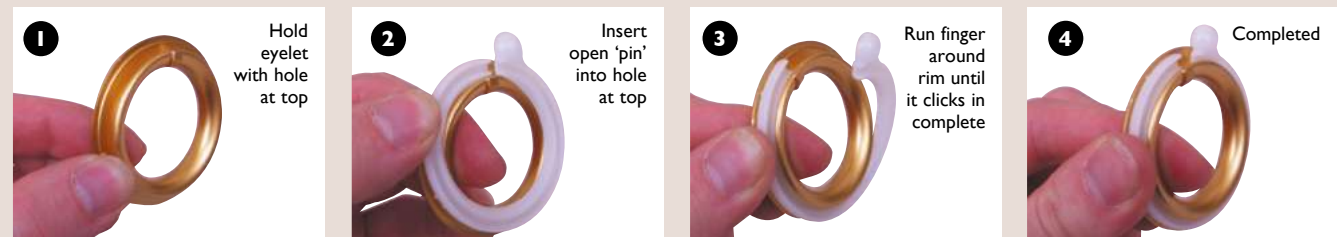

When eyelet is clipped together, the fabric edge is sealed and will not fray. (For accurate, easy and neat hole cutting use the Eyelet Easy Cutter or Eyelet Press).

DISCLAIMER: Whilst every effort has been made to ensure colour accuracy, due to the limitations of colour printing, please refer to product samples for colour matching. Product dimensions are for guidance only and may differ – please confirm details at time of ordering.

Eyelets

Click & Twist Plastic Eyelets

Click & Twist Plastic Eyelets are Ideal for voiles, nets, light weight pelmets, curtains, panels, blinds or pelmet decorations.

Colours: Replace **X** in order code for your chosen colour letter ref



ID 35mm
OD 55mm

Click & Twist Plastic Eyelets simply 'click' together by pushing both sides and then you can 'twist' them apart if you need to clean the curtains or re-use the eyelets elsewhere. See guide below for full details.



MATT BRASS

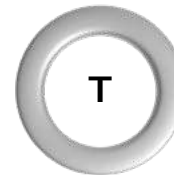

MATT CHROME



BLACK

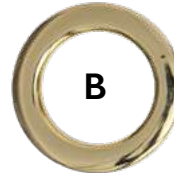

BRASS



CHROME



PEWTER

Click & Twist 40mm Eyelets

Punch hole of 40mm. Suitable for up to 30mm diameter poles.

Pre-packed: 10 px Code: 44EYC4D**X**

Packed loose: 100 Code: 44EYC4C**X**

How it works: Step-by-Step Guide to Use



40mm eyelets that simply 'click' together and can be easily taken off by 'twisting' the eyelet without damaging the curtain or the eyelet.

Eyelet Tools Easy Cutter

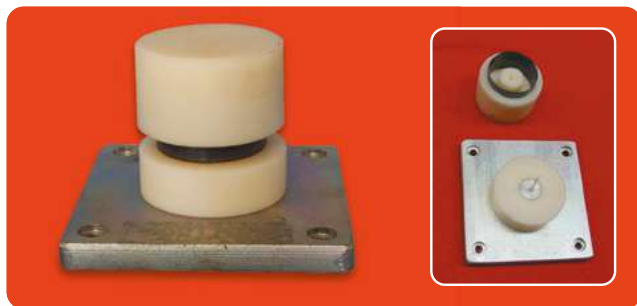

40mm Eyelet Easy Cutter
55mm Eyelet Easy Cutter

Code: 44EY4CUT
Code: 44EY5CUT

Eyelet Easy Cutter for quick, accurate and neat hole cutting with little effort. Cutter can be used for all types of eyelets.

NOTE: It is recommended to fix cutter to a table when in use. Lead weight or rubber mallet is recommended for use with eyelet cutter to avoid damage and reduce noise in hole cutting. Spare parts for cutter are available for purchase.

Spare Accessories also available:

- Spare blades – 40mm, 55mm
- Spare tops including blades also available.
- Cutting Base (Plastic Anvil) 40mm/55mm.
- Centre pin with fixing screw.
- Metal Base only.

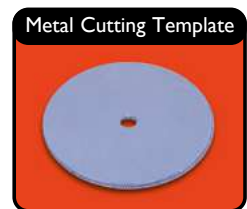

Step by Step Guide to Use

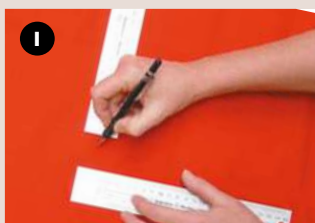

Mark centre point of eyelet.

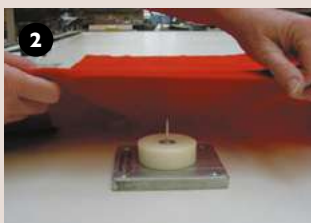

Pass fabric over cutter and push pin through fabric at desired position.



Align cutter top on the centre pin and then using a mallet, hit the cutter.



Rotate cutter top to ensure circle is cut all the way round.

DISCLAIMER: Whilst every effort has been made to ensure colour accuracy, due to the limitations of colour printing, please refer to product samples for colour matching. Product dimensions are for guidance only and may differ – please confirm details at time of ordering.

Renaissance Galaxy Eyelets

Renaissance Galaxy Eyelets have a 2-Part Clip-In design. Also compatible with Rufflette Solar Tape and Jupiter Rings.



Galaxy Eyelets can also be used without a tape. Simply use our Easy Cutter on p209 to cut holes directly into your chosen curtain fabric.

Renaissance Galaxy Eyelets

Diameter: 36mm Suitable for poles up to 28mm diameter.

Packed: Tube 36px **Code:** 52TRGALX

Contract Box: 250px in select colours – ask for details.

Colours: Replace **X** in order code for your chosen colour letter ref



Clip-in-Plastic Eyelets & Tape

Renaissance Clip-In-Plastic Eyelets are compatible with Renaissance Clip-in-Plastic Eyelet Tape.



Renaissance Clip-in-Plastic Eyelets

Diameter: 38mm Suitable for poles up to 28mm diameter.

Packed loose: Box 50px **Code:** 50TOCEYX

Colours: Replace **X** in order code for your chosen colour letter ref

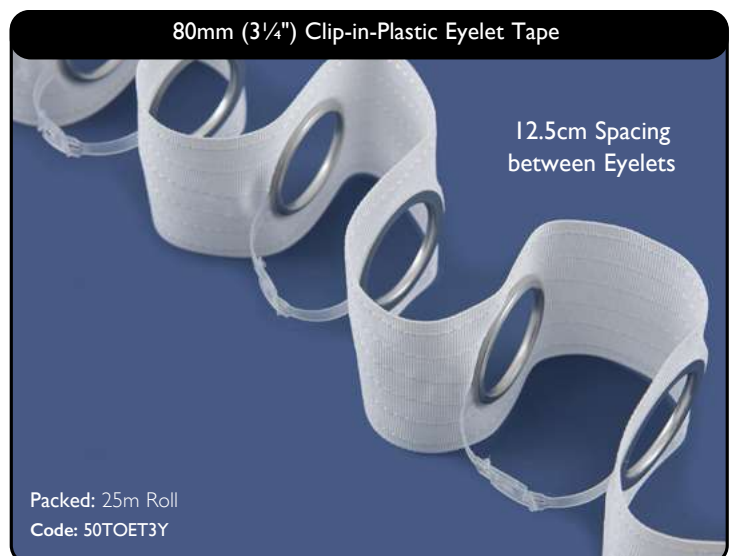

DISCLAIMER: Whilst every effort has been made to ensure colour accuracy, due to the limitations of colour printing, please refer to product samples for colour matching. Product dimensions are for guidance only and may differ – please confirm details at time of ordering.

150mm (6") Extra Deep Woven Pocket Pencil Pleat Tape

4 high density woven pockets. Polypropylene weft. 4 high quality cord set in tubes for easy pleating and long luxurious, crisp pleats that won't spread, bunch or tip. Single sided.

Packed: 50m Roll **Fullness:** 1:2.5 **Pockets:** Woven

Code: 48TSDW6R Roll

152mm (6") Extra Deep Cord Pocket Pencil Pleat Tape

6 cord pockets, double sided tape, for extra deep headings and long drops.

Packed: 50m Roll **Fullness:** 1:2-2.5 variable **Pockets:** Cord

Code: 48TSDP6R Roll

76mm (3") Regal Pencil Pleat Tape White

3 woven pockets, single sided premium quality tape with nylon monofilament reinforcing. Superb definition.

Packed: 50m Roll or 500m Lapped **Fullness:** 1:2.5 variable **Pockets:** Woven

Code: 48TSRE3R Roll
Code: 48TSRE3L Lapped

76mm (3") Regal Pencil Pleat Tape Black

2 woven pockets, single sided premium quality tape with nylon monofilament reinforcing. Superb definition.

Packed: 50m Roll **Fullness:** 1:2.5 variable **Pockets:** Woven

Code: 48TSREK3R

76mm (3") Precedent Woven Pocket Pencil Pleat Tape

3 woven pockets, uniquely interwoven. Monofilament reinforcement. Single sided.

Packed: 50m Roll or 500m Lapped **Fullness:** 1:2-2.5 variable **Pockets:** Woven

Code: 49TCPT3R Roll
Code: 49TCPT3L Lapped

76mm (3") Touch 'n' Close Pencil Pleat Tape

For hook tape application to pelmets, dress curtains etc. Super quality. Continuous Pocket. Single sided.

Packed: 50m Roll **Fullness:** 1:2 variable **Pockets:** N/A

Code: 49TCTC3R Roll
Code: 49TCTC3L Lapped

85mm (3½") Smocking Pleat Tape

2 woven pockets, single sided mocking pleat tape. Ideal for Valances.

Packed: 50m Roll **Fullness:** 1:2 **Pockets:** Woven

Code: 48TSSM3R Roll

90mm (3½") Trident Pinch Pleat Tape

2 woven pockets, single sided nylon monofilament reinforced pinch pleat tape. Forms a fan/trident shape.

Packed: 50m Roll **Fullness:** 1:2 **Pockets:** Woven

Code: 48TSTR3R Roll

100mm (4") Corona Multipleat Tape

3 woven pockets. Single sided. Forms several pencil pleats to form a half round cluster.

Packed: 50m Roll **Fullness:** 1:4 **Pockets:** Woven

Code: 48TSCO4R Roll

DISCLAIMER: Whilst every effort has been made to ensure colour accuracy, due to the limitations of colour printing, please refer to product samples for colour matching. Product dimensions are for guidance only and may differ – please confirm details at time of ordering.

Curtain Heading Tapes Pencil Pleat Tapes

76mm (3") Principal Woven Pocket Pencil Pleat Tape

3 woven pockets for maximum performance. Single sided.
Packed: 50m Roll or 500m Lapped. **Fullness:** 1:2 variable **Pockets:** Woven

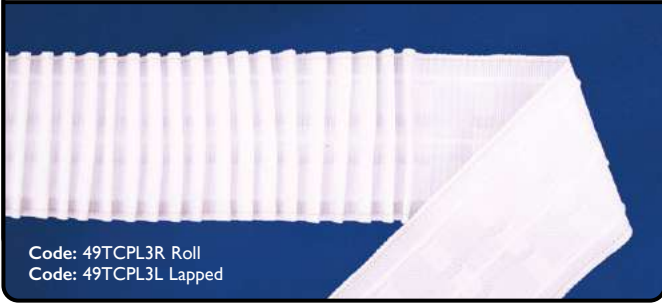

Code: 49TCPL3R Roll
 Code: 49TCPL3L Lapped

76mm (3") Premium Woven Pocket Pencil Pleat Tape

Superb value 3 woven pocket tape. Contract quality. Single sided.
Packed: 50m Roll or 500m Lapped. **Fullness:** 1:2 variable **Pockets:** Woven

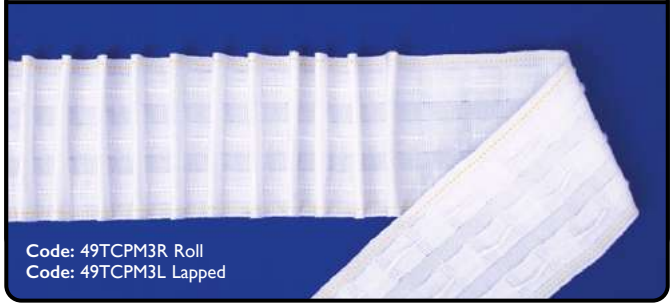

Code: 49TCPM3R Roll
 Code: 49TCPM3L Lapped

76mm (3") Multiwove Woven Pocket Multi-pocket Pencil Pleat Tape

5 woven pockets for quality curtains and adjustability. Single sided.
Packed: 50m Roll or 500m Lapped. **Fullness:** 1:2 variable **Pockets:** Woven



Code: 48TCMW3R Roll
 Code: 48TCMW3L Lapped

76mm (3") Multi-pocket Pencil Pleat Tape

8 cord pockets for exact hanging and maximum adjustability. Single sided.
Packed: 100m Roll or 500m Lapped. **Fullness:** 1:1.5-3 variable **Pockets:** Cord



Code: 51TOMU3C Roll
 Code: 51TOMU3L Lapped

76mm (3") Super Pencil Pleat Tape

3 polyester cord pockets, best quality double sided workroom pencil pleat tape.
Packed: 100m Roll or 500m Lapped. **Fullness:** 1:2-2.5 variable **Pockets:** Cord



Code: 49TCSU3R Roll
 Code: 49TCSU3L Lapped

76mm (3") Super Pencil Pleat Tape with Sewing Line

3 polyester cord pockets, best quality double sided workroom pencil pleat tape.
Packed: 100m Roll or 500m Lapped. **Fullness:** 1:2-2.5 variable **Pockets:** Cord

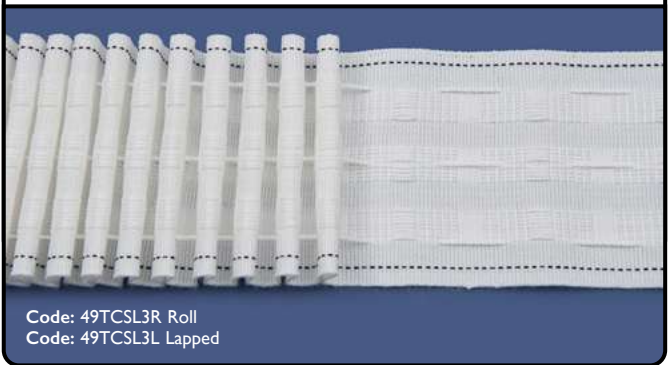

Code: 49TCSL3R Roll
 Code: 49TCSL3L Lapped

76mm (3") Flame Retardant Pencil Pleat Tape

Flame retardant 3 woven pocket tape including monofilament stiffening suitable for contracts. Conforms to British Standard BS:5867 part 2. Single sided.
Packed: 50m Roll or 500m Lapped. **Fullness:** 1:2.5 **Pockets:** Woven



Code: 49TCFR3R Roll
 Code: 49TCFR3L Lapped



50mm (2") Standard Pencil Pleat Tape

2 cord pockets with black sewing line, for cottage curtains, valances etc. Double sided.
Packed: 50m Roll **Fullness:** 1:2-2.5 variable **Pockets:** Cord



Code: 49TCCP2R Roll

DISCLAIMER: Whilst every effort has been made to ensure colour accuracy, due to the limitations of colour printing, please refer to product samples for colour matching. Product dimensions are for guidance only and may differ – please confirm details at time of ordering.

ESSENTIALS WORKROOM ACCESSORIES

Curtain Heading Tapes Pencil Pleat Tapes

25mm (1") Standard White Pencil Pleat Tape

Single woven pocket polyester pencil pleat tape for pelmets & cottage curtains. Single sided.
Packed: 100m Roll or 1000m Lapped. **Fullness:** 1:2 **Pockets:** Woven

Code: 49TCCP1C Roll
 Code: 49TCCP1K Lapped

Curtain Heading Tapes Transparent Tapes

50mm (2") Net Curtain Pencil Pleat Tape

2 woven pockets, for professional net headings. Single Sided.
Packed: 50m Roll. **Fullness:** 1:2.5 variable. **Pockets:** Woven

Code: 50TONT2R Roll

75mm (3") Transparent Voile Pencil Pleat Tape

2 woven pockets for nets and voile curtains. 100% polyester tape.
 Includes transparent cord. Single sided.
Packed: 100m Roll **Fullness:** 1:2 **Pockets:** Woven

Code: 51TOTV3C Roll

Curtain Heading Tapes SurgeWave Tape

SurgeWave® System

The SurgeWave System from Renaissance gives a consistent heading without having to pull any strings and with your curtains open SurgeWave stacks back to give a tidy, minimalistic look.

How it works – SurgeWave Spacing Indicators: The pockets required for 60mm & 80mm spacing hooking points are clearly marked for easy, accurate glider insertion!

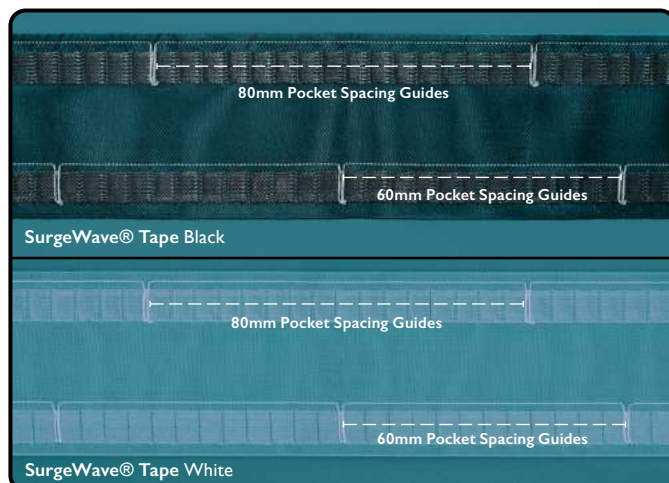

75mm SurgeWave® System Tape

SurgeWave® System Curtain Tape With 60mm & 80mm Spacing Guides		
<input type="checkbox"/> White	Packed: 50m	Code: 51TOWA3R
<input type="checkbox"/> White	Packed: 100m	Code: 51TOWA3CR
<input checked="" type="checkbox"/> Black	Packed: 50m	Code: 51TOWAK3R
Min Qty: 100m		
Iron-on SurgeWave® System Curtain Tape		
<input type="checkbox"/> White	Packed: 50m	Code: 51TOWIA3R
Min Qty: 100m		

DISCLAIMER: Whilst every effort has been made to ensure colour accuracy, due to the limitations of colour printing, please refer to product samples for colour matching. Product dimensions are for guidance only and may differ – please confirm details at time of ordering.

20mm (3/4") White Spooled Roman Blind Tape Slotted

Slotted tubular tape for inserting Roman Blinds bars with pockets for vertical cords.
Bars Accepted: Fibreglass, oval (white/transparent) & wood dowel (6mm & 9mm)
Packed: 100m Roll or 1000m Lapped.

Code: 50TRBWPC Roll
 Code: 50TRBWPK Lapped

20mm (3/4") Cream Spooled Roman Blind Tape Slotted

Slotted tubular tape for inserting Roman Blinds bars with pockets for vertical cords.
Bars Accepted: Fibreglass, oval (white/transparent) & wood dowel (6mm & 9mm)
Packed: 100m Roll or 1000m Lapped.

Code: 50TRBCPC Roll
 Code: 50TRBCPK Lapped

18mm (3/4") Transparent Roman Blind Tape Slotted

Slotted tubular tape for inserting blind bars with pockets for vertical cords.
Bars Accepted: Fibreglass, oval (white/transparent) and wood dowel (6mm only)
Packed: 200m Roll – Transparent for use with voiles.

Code: 51TRBTRR Roll

26mm (1") Cream Boxed Roman Blind Tape Slotted

High quality slotted tubular tape for inserting blind bars with pockets for vertical cords.
Bars Accepted: Fibreglass, oval (white/transparent) & wood dowel (6mm & 9mm)
Packed: 100m Roll

Code: 50TRBCBC Roll

20mm (3/4") White Select Roman Blind Tape Non Slotted

Non Slotted Tubular Tape for inserting blind bars, with pockets for vertical cords.
Bars Accepted: Fibreglass, oval (white/transparent) and wood dowel (6mm only)
Packed: 100m Roll

Code: 50TRBWSC Roll

20mm (3/4") Cream Select Roman Blind Tape Non Slotted

Non Slotted Tubular Tape for inserting blind bars, with pockets for vertical cords.
Bars Accepted: Fibreglass, oval (white/transparent) and wood dowel (6mm only)
Packed: 100m Roll

Code: 50TRBCSC Roll

Roman/Austrian Blind Accessories

Austrian/Roman Blind Rings



Clear Packed: 100 Code: 58WRABCO
 Clear Packed: 1000 Code: 58WRABKO
 Min Qty: 10 OD = 11mm ID = 8mm

Roman Blind Clip & Ring



Clear Packed: 100 Code: 58WCRGCC
 Clear Packed: 1000 Code: 58WCRGKC
 Min Qty: 100

8mm Screw Eyes



Brassed Code: 58WSE08B
 Chrome Code: 58WSE08S
 Packed: 100 Min Qty: 100

Roman/Austrian Cords & Cording Accessories

Medium Braided Blind Cord



Thickness: 1.0mm Code: 50TOABCS
 Packed: 500m Spool Min Qty: 1 Spool

Medium Warp Knitted Blind Cord



Thickness: 1.2mm Code: 50TOABCM
 Packed: 250m Spool Min Qty: 1 Spool

Supercord Braided Blind Cord

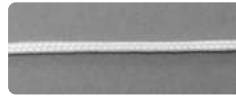

Thickness: 1.5mm Code: 50TOABCU
 Packed: 250m Spool Min Qty: 1 Spool

Thick Braided Blind Cord



Thickness: 2.5mm Code: 50TOABCT
 Packed: 100m Spool Min Qty: 1 Spool



Cord Connector For Combining Cords

Aluminium Packed: 100 Code: 17HVCCDS
 Min Qty: 10



Cord Connector For Combining Cords

White Packed: 100 Code: 17HVCCDW
 Min Qty: 10

DISCLAIMER: Whilst every effort has been made to ensure colour accuracy, due to the limitations of colour printing, please refer to product samples for colour matching. Product dimensions are for guidance only and may differ – please confirm details at time of ordering.

Renaissance Hook & Loop Tape

Premium quality Hook & Loop Tapes are available in either strong Self Adhesive or Sew-on Tapes, each supplied separately on 25m rolls.

Other colour Hook & Loop Tapes, self adhesive dots and pre-packs of other products available by special order.

Hook Tape (Hard Side)



Loop Tape (Soft Side)

Hook Tape Self Adhesive	Colour	Code
Self Adhesive 20mm (¾")	☐ White	53C2AHRW
Self Adhesive 25mm (1")	☐ White	53C1AHRW
Self Adhesive 50mm (2")	☐ White	53C5AHRW
Self Adhesive 20mm (¾")	■ Black	53C2AHRK
Self Adhesive 50mm (2")	■ Black	53C5AHRK

Loop Tape Self Adhesive	Colour	Code
Self Adhesive 20mm (¾")	☐ White	53C2ALRW
Self Adhesive 25mm (1")	☐ White	53C1ALRW
Self Adhesive 50mm (2")	☐ White	53C5ALRW
Self Adhesive 20mm (¾")	■ Black	53C2ALRK
Self Adhesive 50mm (2")	■ Black	53C5ALRK

Hook Tape Sew-On	Colour	Code
Sew-On 20mm (¾")	☐ White	53C2SHRW
Sew-On 25mm (1")	☐ White	53C1SHRW
Sew-On 50mm (2")	☐ White	53C5SHRW
Sew-On 20mm (¾")	■ Black	53C2SHRK
Sew-On 50mm (2")	■ Black	53C5SHRK

Loop Tape Sew-On	Colour	Code
Sew-On 20mm (¾")	☐ White	53C2SLRW
Sew-On 25mm (1")	☐ White	53C1SLRW
Sew-On 50mm (2")	☐ White	53C5SLRW
Sew-On 20mm (¾")	■ Black	53C2SLRK
Sew-On 50mm (2")	■ Black	53C5SLRK



Packed: 25m Roll

Workroom Accessories Lead Weights • Lead Weight Tapes

Lead Weight Tapes

Weight: 14g*	Packed: 200m Roll	Code: 51TL014R
Weight: 25g	Packed: 100m Roll	Code: 51TL025C
Weight: 50g	Packed: 100m Roll	Code: 51TL050C
Weight: 100g	Packed: 50m Roll	Code: 51TL100R
Weight: 150g	Packed: 25m Roll	Code: 51TL150Y
Weight: 200g	Packed: 20m Roll	Code: 51TL100T

*Special Order only

Lead Weights in Paper

Sew-In Design.
Weight: 13g
Code: 59WLT13-

Packed: 100 px

Round Penny Lead Weights

2 Sizes Available:
25mm Weight: 13g
Code: 59WLP25-
19mm Weight: 8g
Code: 59WLP19-

Packed: 100 px

Oblong Lead Weights

White Powder Coated finish. 2 Sizes Available:
Weight: 25g Length: 75mm Code: 59WLO25W
Weight: 13g Length: 38mm Code: 59WLO13W
Packed: 100 px

Workroom Accessories Sprays & Solutions

Venetian Blind Cleaner

Size: 500ml Spray Bottle
Code: 58SPVBHL
Packed: 1 / Outer 20

Spray Adhesive Aerosol

Size: 500ml Can
Code: 58SPAD50
Packed: 1 / Outer 12

Silicone Lubricant Aerosol

Size: 400ml Can
Code: 58SIR217
Packed: 1 / Outer 12

Silicone Lubricant ideal for use on metal, plastic, rubber, vinyl & moving parts.

DISCLAIMER: Whilst every effort has been made to ensure colour accuracy, due to the limitations of colour printing, please refer to product samples for colour matching. Product dimensions are for guidance only and may differ – please confirm details at time of ordering.

Woven Canvas 'Double Sided' Fusible



Available Sizes:
 100mm (4") Code: 54FUWD4R
 125mm (5") Code: 54FUWD5R
 150mm (6") Code: 54FUWD6R
 Colour: White
 Packed: 50m roll

Woven Canvas Non-Fusible – Sanforised



Available Sizes:
 100mm (4") Code: 54NFWS4C
 125mm (5") Code: 54NFWS5C
 150mm (6") Code: 54NFWS6C
 Colour: White
 Packed: 100m roll

Woven Canvas 'Single Sided' Fusible



Available Sizes:
 100mm (4") Code: 54FUWS4R
 125mm (5") Code: 54FUWS5R
 150mm (6") Code: 54FUWS6R
 Colour: White
 Packed: 100m roll

Non Woven Stiffener – Non-Fusible



Available Sizes:
 200mm (8") Code: 54FFN085
 300mm (12") Code: 54FFN125
 Colour: White
 Packed: 50m roll

Non Woven Canvas 'Double Sided' Fusible



Available Sizes:
 100mm (4") Code: 54FUND45
 125mm (5") Code: 54FUND55
 150mm (6") Code: 54FUND65
 Colour: White
 Packed: 50m roll

Non Woven Eyelet Buckram – White



Non fusible. 100% polyester.
 Suitable for 25 & 40mm eyelets.
 Available Size:
 77mm (3") Code: 54NWEB3R
 Packed: 100m roll

Workroom Accessories Rings

32mm (1 1/4") Large Brass Split Rings



Colour: Brass
 Packed: 100px 58WS31CB
 Packed: 1000px 58WS31KB

25mm (1") Brass Rings



Colour: Brass
 Packed: 100px 58WR25CB
 Packed: 1000px 58WR25KB

1" Brass D-Rings



Colour: Brass
 Packed: 100px 58WD25CB
 Packed: 1000px 58WD25KB

25mm (1") Small Brass Split Rings



Colour: Brass
 Packed: 100px 58WS25CB
 Packed: 1000px 58WS25KB

19mm (3/4") Brass Rings



Colour: Brass
 Packed: 100px 58WR19CB
 Packed: 1000px 58WR19KB

1" Chrome D-Rings



Colour: Chrome
 Packed: 100px 58WD25CS
 Packed: 1000px 58WD25KS

DISCLAIMER: Whilst every effort has been made to ensure colour accuracy, due to the limitations of colour printing, please refer to product samples for colour matching. Product dimensions are for guidance only and may differ – please confirm details at time of ordering.

Pre-Packed Branded Plastic Curtain Hooks



White Plastic Curtain Hooks available in Renaissance branded poly-bag packs with Euro-slot hanger

Pre-Packed:
 25px/Outer 25 Code: 58PLCH25
 100px/Outer 25 Code: 58PLCH1C
 300px/Outer 25 Code: 58PLCH3C

Available in 3 handy pack sizes:

PACK OF 25 **PACK OF 100** **PACK OF 300**

Renaissance Metal Curtain Hooks

With an improved design, our high quality Metal Curtain Hooks come in a Chrome or Brass finish. They're the market leader!

- ✓ Stronger & Shorter
- ✓ Stays in the tape
- ✓ Hooks don't tangle

Can easily be taken from the pack one hook at a time



Available in: Chrome or Brass finish

Packed: 100px/Outer 10 ● 58MHCHCS ● 58MHCHCB	Packed: 1000px/Outer 1 ● 58MHCHK ● 58MHCHKB	Pre-Packed: 25px/Outer 10 ● 46-0325S ● 46-0325B	Pre-Packed: 100px/Outer 10 ● 58MHCHPCS
---	--	--	--

Rounded Curtain Hooks

Smooth for fast & easy insertion!



Pre-Packed: 25px/Outer 100
○ White 58RHPR25W

Packed: 100px
○ White 58RH-100W

Packed: 1000px
○ White 58RH1000W
● Black 58RH1000K

Made of Polyacetal
Very strong and won't go brittle in sunlight.

Heavy Duty Curtain Hooks



Pre-Packed: 25px/Outer 100
○ 58HHPR25

Packed: 100px
○ 58HH-100

Packed: 1000px
○ 58HH1000

Packed: 5000px
○ 58HH5000

Plastic Contract Curtain Hooks



Packed: 1000px
○ 58PH1000

Packed: 5000px
○ 58PH5000

Sew-in Adjustable Curtain Hooks



Packed: 100px 58AHSICP

Packed: 1000px 58AHSIKP

Height: 81mm
Width: 25mm

Pin-on Adjustable Curtain Hooks



Packed: 100px 58AHPOCP

Packed: 1000px 58AHPOKP

Height: 70mm
Width: 24mm

Tridis Hooks



Packed: 100px 58WHTHCS

Packed: 1000px 58WHTHKS

Steel Pin Hooks



Pre-Packed: 20px/Outer 10 58WHPIPS

Packed: 100px 58WHPICS









Packed: 1000px 58WHPIKS

For pinch pleat/buckram headings & valances





DISCLAIMER: Whilst every effort has been made to ensure colour accuracy, due to the limitations of colour printing, please refer to product samples for colour matching. Product dimensions are for guidance only and may differ – please confirm details at time of ordering.

Workroom Accessories Sundries

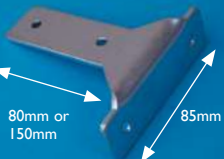
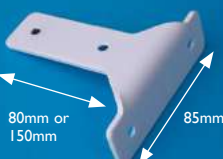

ESSENTIALS WORKROOM ACCESSORIES

<p>Small Metal S-Hooks</p>  <p>Size: 29mm 16H0071S Packed: 100 px</p>	<p>Large Metal S-Hooks</p>  <p>Size: 39mm 16H0072S Packed: 100 px</p>	<p>Plastic S-Hook</p>  <p>Size: 39mm 16H0995W Packed: 1000 px</p>
<p>Plastic Cleat Hooks</p>  <p>Packed: 100 px 58WHCLCP</p>	<p>Plastic Cord Tidy</p>  <p>Packed: 100 px 58WGCTCP</p>	<p>Metal Screw Eyes</p>  <p>Colour: Brassed 58WSE08B Colour: Chrome 58WSE08S Packed: 100px</p>
<p>Clear Roman Blind Clip & Ring</p>  <p>Packed: 100px 58WCRGCC Packed: 1000px 58WCRGKC</p>	<p>Austrian Blind Rings</p>  <p>Ø Outer: 11mm Ø Inner: 8mm Packed: 100px 58WRABCO Packed: 1000px 58WRABKO</p>	<p>10mm White Track Spacers</p>  <p>Packed: 100 px 16HSSPCW</p>

Workroom Accessories Pelmet Brackets

<p>Slotted L-Shape Pelmet Bracket Galvanised</p>  <p>Available Sizes: 100x75mm (4x3") 59WPBLS 125x100mm (5x4") 59WPBLMS 150x125mm (6x5") 59WPBLLS Packed: 20 px</p>	<p>Slotted L-Shape Pelmet Bracket White</p>  <p>Available Sizes: 100x75mm (4x3") 59WPBLSW 125x100mm (5x4") 59WPBLMW 150x125mm (6x5") 59WPBLLW Packed: 20 px</p>	
<p>T-Shape Pelmet Brackets Galvanised</p>  <p>Available Sizes: 85x80mm (3¼x3") 59WPBTSS 85x150mm (3¼x6") 59WPBTLS Packed: 20 px</p>	<p>T-Shape Pelmet Brackets White</p>  <p>Available Sizes: 85x80mm (3¼x3") 59WPBTSW 85x150mm (3¼x6") 59WPBTLW Packed: 20 px</p>	<p>L-Shape Pelmet Bracket</p>  <p>Galvanised L-Shape Plate Size: 40 x 40mm 59WPPLZS Packed: 100 px</p>

Roller Blind & Vertical Blind Replacement Accessories

<p>Roller Blind Accessories</p> <p>Roller Blind Fitting Set Inc. 1m Plastic Chain Code: 66RPFITL Packed: 10px</p>  <p>Children can strangle if this safety device is not installed. Always use this device to keep cords or chains out of reach of children.</p> <p>Young children can be strangled by loops in pull cords, chains and tapes, and even cords that separate the product. To avoid strangulation and entanglement, keep cords out of the reach of young children. Cords may become wrapped around a child's neck. Move beds, cots and furniture away from windows covering cords. Do not tie cords together. Make sure cords do not twist and create a loop.</p>	<p>Vertical Blind Accessories</p>  <p>Vertical Blind Chain with Clips Size: 89mm Code: 67VCH09PW Size: 127mm Code: 67VCH13PW Packed: 250m Roll</p>  <p>Vertical Blind Bottom Weight Size: 89mm Code: 67VBW09CW Size: 127mm Code: 67VBW13CW Packed: 300 (100)</p>
--	--

DISCLAIMER: Every effort has been made to ensure colour accuracy, due to the limitations of colour printing, please refer to product samples for colour matching. Product dimensions are for guidance only and may differ – please confirm details at time of ordering.

Bejewelled Medium End Hook

Size: H 35mm, P 40mm
Packed: 25px

- **Satin Nickel:** 46MD325T
- **Chrome:** 46MD325S
- **Black Nickel:** 46MD325I
- **Antique Brass:** 46MD325A
- **Brass:** 46MD325B
- **Black:** 46MD325K

SATIN CHROME CHROME BLACK NICKEL ANTIQUE BRASS BRASS BLACK

new

Ball End Hook BH3

Size: H 30mm, P 35mm
Packed: 25px

- **Chrome:** 46-0325S
- **Brass:** 46-0325B
- **Black:** 46-0325K
- **White:** 46-0325W

CHROME BRASS BLACK WHITE

Security Tieback Hook

Size: H 77mm, P 30mm
Packed: 25px

- **Satin Chrome:** 46SH125T
- **Black Nickel:** 46SH125I
- **Antique Brass:** 46SH125A
- **Chrome:** 46SH125S
- **Brass:** 46SH125B
- **Black:** 46SH125K

new

Medium Ball End Hook MBH3

Painted Colour Finish
Size: H 35mm, P 40mm
Packed: 25px

- **Dark Grey:** 46M0325Y
- **Light Grey:** 46M0325G
- **Cream:** 46M0325C
- **Black:** 46M0325K
- **White:** 46M0325W

Includes 3 **NEW** colours to compliment the Natur Shades Range **See p36**

DARK GREY LIGHT GREY CREAM BLACK WHITE

Shield Hook CB2

Packed: 25px

- **Satin Brass**
Code: 47C0225G
- **Satin Chrome**
Code: 47C0225T

Size:
H 86mm
P 35mm

Metallic Colour Finishes
Size: H 35mm, P 40mm
Packed: 25px

- **Satin Brass:** 47C0325G
- **Satin Chrome:** 47C0325T
- **Black Nickel:** 47C0325M
- **Antique Brass:** 47C0325A
- **Chrome:** 46M0325S
- **Brass:** 46M0325B

CHROME BRASS ANTIQUE BRASS
SATIN CHROME SATIN BRASS BLACK NICKEL

Fleur-de-Lys Hook

Size:
H 72mm
P 33mm

Packed: 25px

- **Chrome:** 46-0725S
- **Brass:** 46-0725B

Swirl Hook CBI

Size:
H 80mm
P 35mm

Packed: 25px

- **Satin Brass**
Code: 47C0125G

Large Ball End Hook LBH3

Size: H 45mm, P 52mm
Packed: 25px

- **Chrome:** 46L0325S
- **Brass:** 46L0325B
- **Black:** 46L0325K

CHROME BRASS BLACK

Eagle Claw Hook

Size: H40mm, P45mm

Packed: 25px

- **Brass:** 46-0825B

Classic Hook

Size: H36mm, P45mm

Packed: 25px

- **Brass:** 46-0925B

Rosette Hook BH1

Size: H 32mm, P 43mm
Packed: 25px

- **Chrome:** 46-0125S
- **Brass:** 46-0125B
- **Black:** 46-0125K

CHROME BRASS BLACK

Metal Cleat Hook





Packed: 25px

- **Satin Chrome:** 47C0525T
- **Satin Brass:** 47C0525G
- **Gun Metal:** 47C0525M
- **Antique Brass:** 47C0525A
- **Chrome:** 46-0525S
- **Brass:** 46-0525B
- **Black:** 46-0525K
- **White:** 46-0525W















Size:
L 70mm

DISCLAIMER: Whilst every effort has been made to ensure colour accuracy, due to the limitations of colour printing, please refer to product samples for colour matching. Product dimensions are for guidance only and may differ – please confirm details at time of ordering.

Cord Pulls

<p>Small Rubber Edge Cord Pull SBH-13</p>  <p>Length: 37mm Packed: 25px</p> <ul style="list-style-type: none"> ● Chrome: 46S1325S ● Brass: 46S1325B ● Black: 46S1325K ● Satin Chrome: 46S1325T ● Antique Brass: 46S1325A 	<p>Large Rubber Edge Cord Pull BH-13</p>  <p>Length: 53mm Packed: 25px</p> <ul style="list-style-type: none"> ● Chrome: 46-1325S ● Black: 46-1325K 	<p>Contemporary Cord Pull CB-13</p>  <p>Length: 40mm Packed: 25px</p> <ul style="list-style-type: none"> ● Chrome: 46C1325S ● Brass: 46C1325B ● Black: 46C1325K ● Black Nickel: 46C1325J ● Satin Chrome: 46C1325T ● Satin Brass: 46C1325G ● Antique Brass: 46C1325A 	<p>Tower Cord Pull CP-40</p>  <p>Length: 51mm Packed: 25px</p> <ul style="list-style-type: none"> ● Chrome: 46C4025S ● Brass: 46C4025B ● Black: 46C4025K ● Black Nickel: 46C4025J ● Satin Chrome: 46C4025T ● Satin Brass: 46C4025G ● Antique Brass: 46C4025A 	<p>Tear Drop Cord Pull CP-50</p>  <p>Length: 52mm Packed: 25px</p> <ul style="list-style-type: none"> ○ Stone: 46C5025C ● Brass: 46C5025B ● Satin Brass: 46C5025G
---	--	--	--	--

Workroom Accessories Branded Curtain Track Compatible Accessories

<p>Swish Nova Deluxe Compatible Gliders</p>  <p>Equivalent to: Swish VDI82</p> <p>Packed: Code: 10 x 10 58WGDXP 100 58WGDXC 1000 58WGDXX</p>	<p>Swish Sologlyde Compatible Gliders</p>  <p>Equivalent to: Swish SI82W</p> <p>Packed: Code: 10 x 10 58WGSXP 100 58WGSXC 1000 58WGSXK</p>	<p>Decorail Track Compatible Brackets</p>  <p>Packed: Code: 10 x 5 58WBDEK 100 58WBDEK 1000 58WBDEK</p>
<p>Swish Valance Compatible Gliders</p>  <p>Equivalent to: Swish L380</p> <p>Packed: Code: 10 x 10 58WGVAD 100 58WGVAC 1000 58WVAKP</p>	<p>Decorail/Monorail Compatible Gliders</p>  <p>Packed: Code: 10 x 10 58WGDEP 100 58WGDEC 1000 58WGDEK</p> <p>Also compatible with: Aluglide Tracks</p>	<p>Swish Sologlyde Original Compatible Brackets</p>  <p>Packed: Code: 10 x 5 58WBSGP 100 58WBSGC 1000 58WBSGK</p>
<p>Swish Fastrack Compatible Gliders</p>  <p>Packed: Code: 10 x 10 58WGFAD 100 58WGFAC 1000 58WGFAP</p>	<p>Harrison Drape Elegance Compatible Gliders</p>  <p>Packed: Code: 10 x 10 58WGELE 100 58WGELE 1000 58WGELE</p>	<p>Swish Twinglyde/Nyloglyde Compatible Gliders</p>  <p>Equivalent to: Swish NI82W</p> <p>Packed: Code: 10 x 10 58WGTWP 100 58WGTWC 1000 58WGTWK</p>
<p>Harrison Drape Extra Drape Compatible Gliders</p>  <p>Equivalent to: Harrison Drape 1791</p> <p>Packed: Code: 10 x 10 58WGEXP 100 58WGEXC 1000 58WGEXK</p>	<p>Woolworth Track Compatible Gliders</p>  <p>Packed: Code: 10 x 10 58WGWOD 100 58WGWOC 1000 58WGWOK</p>	<p>Renaissance Medi Glider</p>  <p>Packed: Code: 100 58WGMGP 1000 58WGMGK</p>
<p>Harrison Drape White/Silver Drape Compatible Gliders</p>  <p>Equivalent to: Harrison Drape 1967</p> <p>Packed: Code: 10 x 10 58WGWSD 100 58WGWSC 1000 58WGWSK</p>	<p>Harrison Drape Super Drape/Standard Drape Compatible Gliders</p>  <p>Equivalent to: Harrison Drape 1940</p> <p>Packed: Code: 10 x 10 58WGSWD 100 58WGSWC 1000 58WGSWK</p>	<p>Swish Sologlyde Original Compatible End Stops</p>  <p>Packed: Code: 10 x 2 58WESGP 100 58WESGC 1000 58WESGK</p>

DISCLAIMER: Whilst every effort has been made to ensure colour accuracy, due to the limitations of colour printing, please refer to product samples for colour matching. Product dimensions are for guidance only and may differ – please confirm details at time of ordering.

Self Adhesive White Net Rail Accessories & Hooks

Net Rail End Hooks



Packed: 100px
Code: 25SAHCLW

Net Rail Centre Support



Packed: 100px
Code: 25SACCLW

Self Adhesive White Large Net Rail End Hooks



Packed: 100px
Code: 25SALCLW

Self Adhesive White Heavy Duty Centre Support



Packed: 100px
Code: 25SHC2PW

Self Adhesive Hexagonal Tieback Hooks

Packed: 50px



Chrome
Code: 25SA950S



White
Code: 25SA950W



Brassed
Code: 25SA950B

Net Suspension Twist Tension Rods • Curtain Wire & Accessories

Adjustable Twist Tension Rods

Our heavy duty Twist Tension Rod is ideal for net curtains, voiles, lightweight curtains and shower curtains.

Lengths min-max	Diameter outer section	Bulk Packed Outer: 50
40-61cm (16-24")	13mm	30TB040W
56-92cm (22-36")	13mm	30TB056W
91-152cm (36-60")	13mm	30TB090W
122-183cm (48-72")	13mm	30TB122W
160-250cm (63-98")	13mm	30TB162W
228-355cm (90-140")	17mm	30TB228W

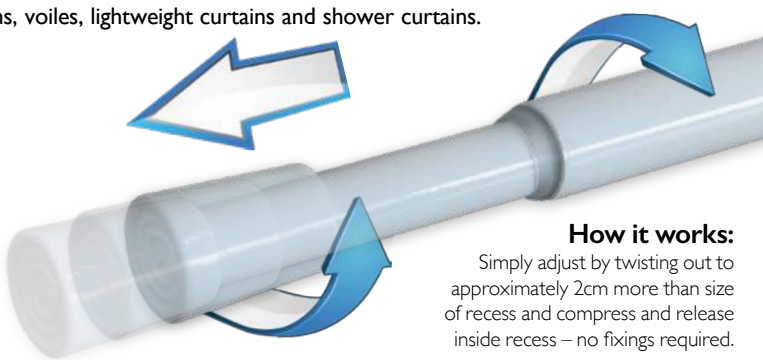

How it works:

Simply adjust by twisting out to approximately 2cm more than size of recess and compress and release inside recess – no fixings required.

Extra large diameter, strong heavy-duty twist tension rod for shower curtains for straight runs between walls.

Decorative shower curtain hooks to complement and add extra feature to your bathroom or standard shower rings.

Shower Rail Size:
Width 144-255cm (56-100")
Diameter 25mm (1")

Packed: Outer 10
Code: 30SJ144W





Clear Shower Rings
Packed: 12 px / Outer 10
Code: 32SHPR12

Curtain Wire Coil

Top quality curtain wire for strength, tension and expansion.



Size: 30m (100')
Packed: Outer 10
Code: 27CW100-

Eyes for Curtain Wire



Packed loose: Box 200px
Code: 27CW200E

Hooks for Curtain Wire



Packed loose: Box 200px
Code: 27CW200H

DISCLAIMER: Whilst every effort has been made to ensure colour accuracy, due to the limitations of colour printing, please refer to product samples for colour matching. Product dimensions are for guidance only and may differ – please confirm details at time of ordering.

CHILD SAFETY

When it comes to ligatures, Child Safety is paramount. That's why we supply industry approved Child Safety devices on all our cord and chain operated Tracks & Blinds. **You're in safe hands with Renaissance.**



ESSENTIALS WORKROOM ACCESSORIES

Safety Accessories

*  **Sew-In Adjustable Cord Stopper**
Adjust your blind easily and quickly

Clear Packed: 100 Code: 58WACSCC
 Clear Packed: 1000 Code: 58WACSKC

Min Qty: 100

*  **Clip-In/Sew-In Adjustable Cord Stopper**
Adjust your blind easily and quickly

Clear Packed: 100 Code: 58WACCCC
 Clear Packed: 1000 Code: 58WACCKC

Min Qty: 100

*  **Roman Blind Rear Sew-In Cord Release**

White Packed: 100 Code: 58CSSRCT

Min Qty: 100

*  **Roman Blind Rear Clip-in Cord Release**

White Packed: 100 Code: 58CSBACT
 White Packed: 1000 Code: 58CSBAKT

Min Qty: 100

*  **Roman Blind Rear Sew-In Cord Break**

Clear Packed: 100 Code: 58CSCBCT

Min Qty: 100

*  **Safety Boxes**
To be mounted to the wall for use with continuous chain and/or cord operations. For use with vertical and dual control blinds

Single Safety Box Code: 58WASBSG
Double Safety Box Code: 58WASBDB

Packed: 100 Min Qty: 10

*  **Roman/Roller Blind Chain Break**
Enables a chain to break at 6kg

Clear Packed: 100 Code: 58CSCHCT

Min Qty: 100

Safety Accessories

 **Chain/Cord Tensioners**

White

Plastic Tensioner Code: 18CTCTPW
Metal Tensioner Code: 18CTCTMW

Packed: 1 px/Outer 10

*  **Clear 'P-Clip' Chain/Cord Safety Guide**

Code: 58WASCCCL

Packed: 100 Min Qty: 100

 **Cleat Hooks (Accumulation Device)**

White Packed: 100 Code: 58WHCLCP

Min Qty: 100

 **Safety Warning Tag with string**

Code: 58WASTST

Packed: 100 Min Qty: 10

 **Child Safety Warning Label**

Code: 58WASWLA

Packed: Roll of 100

Min Qty: 100

*  **Cord Breakaway for Multiple Cords**
Enables cords to break at 6kg

Clear Packed: 100 Code: 58CSCCCC

Min Qty: 100

 **Cord Connector (Combining Cords)**

White Packed: 100 Code: 17HVCCDW
 Aluminium Packed: 100 Code: 17HVCCDS

Min Qty: 10



* Indicates item has been tested to meet BS EN 13120:2009+A1:2014 Child Safety Standards requirements.

NOTE: Complete elimination of the strangulation risk is only achieved by keeping cords, chains, tapes and similar out of the reach of children. Use of additional safety devices may reduce the risk of strangulation but cannot be considered foolproof. Persons in charge of children are ultimately responsible for following the safety instructions provided by the manufacturer. European Standard BS EN 13120:2009+A1:2014

DISCLAIMER: Whilst every effort has been made to ensure colour accuracy, due to the limitations of colour printing, please refer to product samples for colour matching. Product dimensions are for guidance only and may differ – please confirm details at time of ordering.





RENAISSANCE

DISPLAYS & PROMOTION

RENAISSANCE

DISPLAYS & PROMOTION



RENAISSANCE

TEL 0113 250 4499

• EMAIL SALES@RCA-UK.COM

• VISIT RCA-UK.COM

Displays & Promotion

Renaissance have a wide variety of curtain pole and curtain track range Display Blocks and Boards available. We can also provide Point of Sale Display Stands and supporting promotional product literature – for more information please contact your Account Manager.

Spectrum Display Board
 Displays may vary with colour/design content
 600mm wide x 750mm high

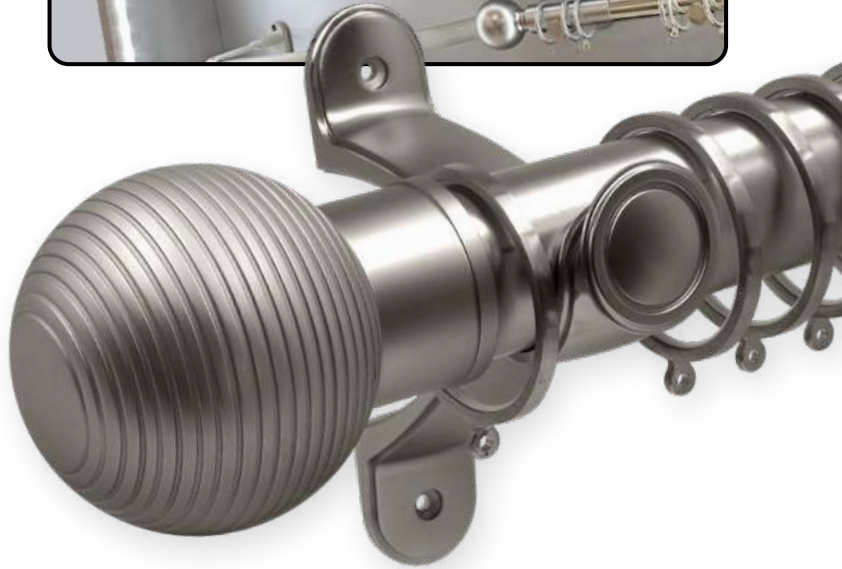

*Spectrum Display Board is available in 4 styles

Spectrum Display Block



Dimensions 28mm Display Block



Duet 50mm Display Block



DISCLAIMER: Whilst every effort has been made to ensure colour accuracy, due to the limitations of colour printing, please refer to product samples for colour matching. Product dimensions are for guidance only and may differ – please confirm details at time of ordering.

Presentation Cases & POS Boards



Glide-Aside Track

Vogue Range Display Board



Distinction Range Display Board



Contract Metal Pole Range



Aluminium Profile Curtain Tracks

Metal Curtain Track Display Board



Dimensions Metal Pole Range



Spectrum Metal Pole Range

DISCLAIMER: Whilst every effort has been made to ensure colour accuracy, due to the limitations of colour printing, please refer to product samples for colour matching. Product dimensions are for guidance only and may differ – please confirm details at time of ordering.



Order Forms

We have developed a number of order forms for our best selling Curtain Tracks and Roman Blinds all of which you can find on our website.







Scan the QR code to direct you to download our latest Order Forms from our website.

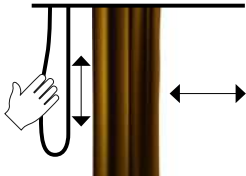

 RENAISSANCE

CORDED TRACK ORDER FORM

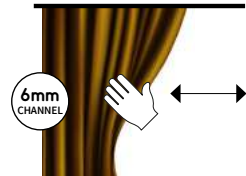

 RENAISSANCE

UNCORDED TRACK ORDER FORM

 RENAISSANCE

UNCORDED TRACK ORDER FORM

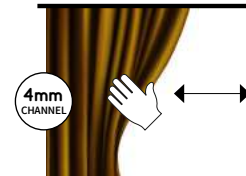

 RENAISSANCE

DISTINCTION TRACK ORDER FORM

 RENAISSANCE

CUBICLE RAIL BEND ORDER FORM

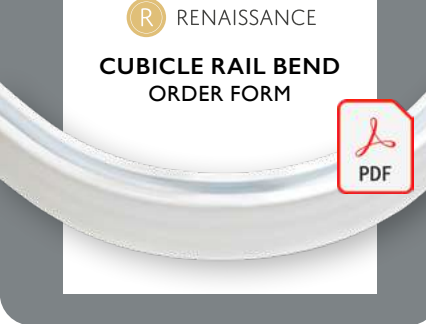
 RENAISSANCE

TRACK BENDING ORDER FORM





 RENAISSANCE

ROMAN BLIND CASSETTE ORDER FORM



 RENAISSANCE

ROMAN BLIND CORE COMPONENTS ORDER FORM

Making it Home™



RETAIL EXCEL ORDER FORM

You can also find all our latest Brochures, Instructions for our entire range of products at our website – visit rca-uk.com

Bending Order Form

Please complete the appropriate details below and include any additional drawings/photos that may help in the completion of your bending request. All measurements provided should be taken at the height the track will be fitted.

Please Note: All bends will have a minimum radius of 100mm. A minimum of 200mm distance is required between two bends.

Measurements shown are of... Track Wall*
 *If wall measurements are provided a deductions in track size will be made in accordance to Project Size requested.

Bracket Type: Wall Fix Ceiling Fix

Bracket Size: _____ cm

Projection Size: _____ cm

Please confirm bend type for Wall Fix bracket positioning

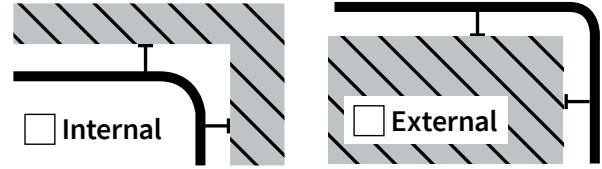

Single Left

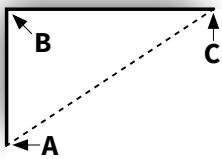

Wall Measurements

A-B _____ mm

B-C _____ mm

Cross Measurement

A-C _____ mm

Angle at B _____

Single Right

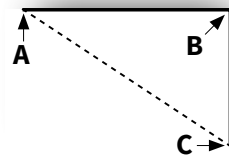

Wall Measurements

A-B _____ mm

B-C _____ mm

Cross Measurement

A-C _____ mm

Angle at B _____

Square Bay

Supplied as 2 piece track unless specified in the tick box below.‡

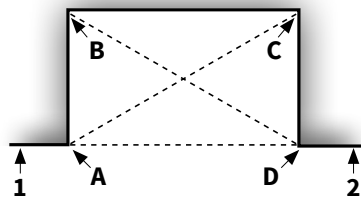

Wall Measurements

A-B _____ mm

B-C _____ mm

C-D _____ mm

Cross Measurement

A-C _____ mm

A-D _____ mm

B-D _____ mm

If possible please confirm Angle at B _____

Two Bend Bay

Supplied as 2 piece track unless specified in the tick box below.‡

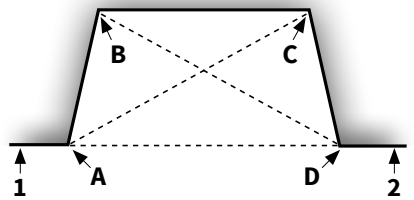

Optional Returns

A minimum return of 200mm is required for external bend

1-A _____ mm

2-D _____ mm

Angle at C _____

Four Bend Bay

Supplied as 2 piece track unless specified in the tick box below.‡

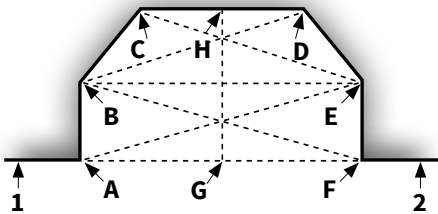

‡ Bay Bends are supplied as 2 piece tracks as standard unless specified

Tick here for 1 piece Track

Wall Measurements

A-B _____ mm

B-C _____ mm

C-D _____ mm

D-E _____ mm

E-F _____ mm

G-H _____ mm

Cross Measurement

B-D _____ mm

C-E _____ mm

B-E _____ mm

A-E _____ mm

B-F _____ mm

A-F _____ mm

Optional Returns

A minimum return of 200mm is required for external bend

1-A _____ mm

2-F _____ mm

Continuous Curved Bay

Supplied as 1 piece track

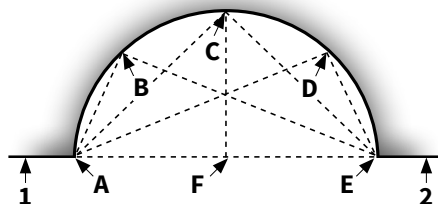

Cross Measurement*

A-B _____ mm

A-C _____ mm

A-D _____ mm

A-E _____ mm

B-E _____ mm

C-E _____ mm

D-E _____ mm

C-F _____ mm

Optional Returns

Note: A minimum return of 200mm is required

1-A _____ mm

2-E _____ mm

* The distance between points A-B, B-C, C-D & D-E should be approximately equal. These points should be temporarily marked on the wall for accurate measuring.

Combined Wood & Metal Curtain Poles

Accents 35mm & 50mm	10-26
---------------------	-------

Handfinished Curtain Poles

Duet 50mm	28-32
-----------	-------

Wooden Curtain Poles

Natur Oaks 35mm & 50mm	34-35
Natur Shades 35mm & 50mm	36-38
Draw Rods	40

Metal Curtain Poles

Spectrum 35mm & 50mm	42-49
Dimensions 28mm	50-63
Contract 35 35mm	64-67
Contract 28 28mm	68-79
Quick-Fit Contract 28 28mm	80
Contract 29 29mm Stainless Steel	81-83
Contract 19 19mm Stainless Steel	84-85
Draw Rods	86

Plastic Curtain Tracks

Jetrack uPVC Track	88
--------------------	----

Metal Tracks

Distinction 28 Corded & Uncorded	90-93
Distinction 20	94-95
Distinction 34	96-97
Vogue Range Curtain Rail	100-102
Metal Tracks Matrix – 4mm Channel	104-105
Metal Tracks Matrix – 6mm Channel	106-107

4mm Channel Profiles

Optimal H-Section	108-110
Principal H-Section	111-113
Mini Optimal H-Section	114-115
Mini Professional Small Curved Profile	116-118
Professional Large Curved Profile	119-122
Mini U-Section Top Fix & Wall Fix	123-124

6mm Channel Profiles

W-Section	125-127
Recess M-Section	128-129
L-Section	130-131
Silent Glide	132-134
Heavy Duty Corded	135-137
Heavy Duty H-Section	138-141
Cubicle Rail	142-145
Motiva Flat	146-148
Motiva Round Corded & Uncorded	149-153
Ocular Ellipse Track	154-157
Glide-Aside Motorised Track	158-161

Other Metal Track Profiles

Veltrack & Blackout Profile Blackout Solution	162-163
I-Beam	164

SurgeWave® System

SurgeWave® System Overview	166-167
SurgeWave® System 4mm Channel	168-169
SurgeWave® System 6mm Channel	170-173
SurgeWave® System All Gliders & Accessories	174-175
SurgeWave® System Gliders Count Matrix	176-177
SurgeWave® System Track Comparison Matrix	178-180

Multi-Channel Metal Tracks

Multi-Channel Matrix	182
Project Track Recess Fix & Ceiling Fix	183-185
Slim-Line Project Track Ceiling Fix	186-187
Panel Track	188-191
Draw Rods	192

Roman Blind Closed Cassette System

AutoMoto™ Motorised Roman Blind	194-195
Workroom Kits	196-197
Safe Release™ Kits	198-199

Roman Blind Components & Accessories

Closed Cassette Components	200
Hook & Loop Tapes	200
Operating Chains	201
Bottom Weight Bars	201
Roman Blind Bars	202
Roman Blind Tape	202
Child Safety – Chain & Rear Cord Devices	203

Essentials Workroom Accessories

Eyelets • Eyelet Tooling • Eyelet Tapes	206-210
Curtain Tapes	211-213
SurgeWave® System Tape & Accessories	213
Roman Blind Tapes	214
Roman Blind Cords & Cord Accessories	214
Hook & Loop Tapes	215
Lead Weights • Lead Weight Tapes	215
Spray & Solutions	215
Stiffeners, Fusibles & Buckrams	216
Curtain Rings	216
Curtain Hooks	217
S-Hooks & Sundries	218
Pelmet Brackets	218
Roller Blind Accessories	218
Vertical Blind Accessories	218
Tieback Hooks & Cleat Hooks	219
Cord Pulls	220
Branded Curtain Track Compatible Accessories	220
Self Adhesive Tieback Hooks	221
Twist Tension Rods	221
Shower Rails	221
Curtain Wire & Accessories	221
Child Safety Products	222

Display & Promotion

Curtain Pole Display Blocks	224
Presentation Cases	225
POS Boards	225

Forms | Notes | Index | T&Cs

Online Forms QR Code	226
Metal Track Bending Form	227
Roman Blind Order Form	228
Notes	229
Information And General Terms & Conditions	231

INFORMATION AND GENERAL TERMS & CONDITIONS

We are an ISO 9001:2015 registered firm.

All business is conducted according to our official Terms & Conditions, a copy of which is supplied to all account holders, and copies are available on request.

RENAISSANCE PRODUCTS COME WITH A 5 YEAR GUARANTEE: Should the product for any reason fail the original invoice must be provided. Guarantee only covers the product – no other items including, but not limited to, fitting costs, travel etc. The guarantee must be registered with Renaissance within 30 days of purchase including invoice reference and details of fixture substrate, fixing method and materials, and of product used. Renaissance reserves the right to reject registration of any product inappropriately used or installed. Guarantees are not transferable.

ORDERING: Orders can be placed by telephone, website or e-mail. When placing orders please state/include your account number and/or postcode, and quote an order number, contact name and telephone number, and delivery address to avoid any confusion or any later misunderstandings. Please use the product's full description and code reference wherever possible, to assist accurate order processing. Orders which include Made-To-Measure goods, will require confirmation in writing. Sales confirmations are despatched to clients for their review awaiting acceptance before despatch. Client confirmation must be received prior to 3:00pm to enable a same day despatch.

DELIVERY: We will endeavour to despatch goods ordered & confirmed before 3:00pm the same day, on our 'Next Day' service*, or to meet your required delivery date.

Proforma payments for customers who do not have credit accounts need to have funds cleared before 3pm and remittance notification to release goods for same day despatch.

Despatch of goods will be delayed if your account is on 'Stop', or you are over your 'Credit Limit'. You will be notified of this status.

In the instance of goods being out of stock, we will notify you, and seek to offer an alternative if applicable.

TRADE COLLECTIONS: Goods being collected require a minimum 4 hours notice for production and operations, and to facilitate our service to our other clients. We will advise of collection time slot. Lunchtimes are 12:00-1:00pm, and collections are not available after 3:00pm. Small order charges also apply.

*Renaissance cannot be held liable for late deliveries due to carrier error/failure.

DELIVERY NOTES: You will receive your delivery with a delivery note attached. If we are out of stock of any items, you will be contacted by our Customer Service Team. Goods will be automatically placed on Back order on our system, unless specific request is made to cancel the back order. If the Back Order is less than £50, we will not process the 'Back Order', and these goods will need to be reordered.

DELIVERIES VIA OUR CARRIERS: Our carriers deliver goods to you from our warehouse. Please inform your 'Goods Inwards' and members of your staff that before signing for any goods or courier acceptance, they must check the delivery for the following:

- They have received the correct & full number of parcels.
- They are all labelled for your company.
- The condition of the delivery, and must note any damages on the courier acceptance, and also immediately notify Renaissance.
- That the security tape has not been tampered with.

We cannot be held responsible for short deliveries where a clear signature has been received for a total delivery. If there are any problems with your delivery it must be noted on the carriers paperwork or system, we must also be informed via our customer service department within 3 working days and confirmed in writing so we can look into your claim. We cannot accept liability for short deliveries if the above requirements are not followed.

BOOKING IN DELIVERIES: Many customers request that deliveries be booked in with their goods inwards department – this must be specified at point of ordering. Our warehouse will make contact and will request a booking reference, time and date. Please note that should a booking-in slot be cancelled or delivery refused once goods have been despatched, this will incur a rebooking and redelivery charge of £25.

SMALL ORDER & ADMINISTRATION & DELIVERY CHARGES: Orders over £250 are delivered on 'Next Day' service carriage free or to your specified date. Orders under £250 incur a small order & administration charge of £17 for 'Next Day' mainland UK.

- For offshore deliveries, please contact our Customer Service team to confirm carriage rates.
- For orders delivered to any third party (site) address or private/residential address an additional charge of £10 will be applied.
- Re-delivery as a result of non-attendance, or refused delivery, per attempt, a charge of £15 will be applied.
- For UK mainland deliveries to business addresses requested before 12:00pm, an extra charge of £15 will be applied
- For UK mainland deliveries to business addresses requested before 10:30am, an extra charge of £35 will be applied
- For UK mainland deliveries to business addresses requested for Saturday, an extra charge of £65 will be applied
- If deliveries are required on pallets, pallet charges will be applied. POA.

SPECIAL ORDERS: All Special Orders & Made To Measure must be placed in writing. Special orders cannot be cancelled or returned after an order has been placed and confirmed.

SHORTAGES & FAULTY GOODS: Claims for shortages, damaged or faulty goods must be notified within 3 days of receipt of goods and confirmed in writing. Claims notified after the 3 days may not be credited. (See 'Deliveries' above).

RETURNS POLICY: We regret we are unable to accept the return of any goods or request for credit without being logged and authorised by our Customer Service Office, who will issue you with a Credit Request Reference Number, which must be included on any relating documentation, and with any goods that are authorised for return.

When goods are authorised for return, please complete our Returns Form and send copy via email to sales@rca-uk.com, including delivery note number and reason for return, to enable us to arrange collection. We will then notify you of collection details.

Goods will be assessed on return to our warehouse, for final credit authorisation. Goods which are assessed as not meeting the credit criteria, or extra unauthorised items, will incur an increased handling charge.

- Goods ordered in error by you may be taken back with prior arrangement and will incur a return carriage charge and / or a handling charge of a minimum 25% of goods & services.
- Goods returned unauthorised will be subject to a handling charge of a minimum 50% of goods & services.
- Made to measure items ordered incorrectly cannot be cancelled or returned for credit.

Customer debit notes will not be accepted without prior authorisation, and any deduction from payments will remain on your account.

Credit notes will be issued once all returns have been received and authorised.

WE DO NOT ACCEPT RETURN GOODS WHICH HAVE BECOME SHOP SOILED OR DAMAGED WHILST ON DISPLAY OR IN CUSTOMERS PREMISES. OUR RESPONSIBILITY DOES NOT EXTEND BEYOND GOODS RECEIVED IN A DAMAGED OR FAULTY CONDITION. WE RESERVE THE RIGHT TO REFUSE TO CREDIT SUCH GOODS RETURNED – YOUR STATUTORY RIGHTS ARE NOT AFFECTED.

PRICES & DESIGNS: Renaissance reserves the right to change designs, specification and prices without prior notice. We reserve the right to improve or change design detail, or dimensions of products without notification to conform to market requirements at any time.

COLOURS: Please note there are different names used for the same or similar colours e.g. Titanium, and Brushed Nickel are similar to Satin Chrome and Stainless Steel. Metal finishes are effect, not necessarily base metal, e.g. Brass (effect) and Stainless Steel (effect).

VAT: All prices exclude VAT. VAT will be charged at the rate in force at time of despatch.

INVOICES, CREDIT NOTES & STATEMENTS: Invoices are rendered on a 30 day nett basis. No settlement discount is offered or allowed, and unauthorised discounts taken will be re-allocated to customer's accounts. Credit notes are issued on authorisation & administration of any claim. Statements are rendered monthly.

OVERDUE ACCOUNTS & CREDIT LIMITS: Credit limits are set for individual accounts, and advised of when the account is opened. Goods will not be despatched where credit limits have been exceeded in value or account is overdue. Overdue accounts will also be subject to a Compensation Charge and statutory interest under the Late Payment of Commercial Debt Regulations 2013.

CARD PAYMENT FACILITY: We accept payment by credit or debit card for proforma orders and accounts payable by phone, and payment link available on electronic invoices and statements. We accept most major credit & debit cards.

ACCOUNTS DEPARTMENT / CREDIT CONTROL: Accounts can be paid over the phone by contacting Credit Control on 0113 238 6952. We do not accept cash or cheque payments.

PRODUCT SELECTION: We offer advice on product selection, but cannot be held responsible for the specification and fitting of any particular product. Every situation is different by way of requirement and customers must satisfy themselves that any particular product is satisfactory for its intended use. No claim will be entertained apart from intrinsic fault or damage to the product existing on delivery.

SIZING: Sizes are shown in metric, and where shown additionally in imperial measurements, the imperial measurements are approximate.

COLOUR VARIATION: Whilst every care and quality control is taken, variations in colour may occur in differing materials and between batches, especially on made to measure, natural materials (like wood) and hand finished products.

HEALTH, SAFETY & WELFARE: All products are designed as carefully as possible, to avoid health and safety hazards. Nevertheless, the nature of many components, can consist of, or include small or sharp items, screws etc, which can constitute a hazard if incorrectly handled, and should at all times be kept out of the reach of children. Please take special care with any corded or chain operated products, and ensure that cords/chains are installed to meet BS:EN13120 standards, in such a manner as not to constitute a risk or strangulation hazard. We cannot be held responsible for the manner, substructure, positioning or fixing of any product, or for any adverse effect caused by any action outside of our direct control.

MADE TO MEASURE: Where this service is requested or supplied, application for made to measure items must always be made in writing, and no responsibility can be accepted for incorrect items when correctly cut to sizes specified. Unfortunately, no allowance can be made once goods are cut if there is any change to specification and orders cannot be cancelled. For volume cut down orders, extra production time may be required prior to despatch.

DISCLAIMER Whilst every effort has been made to ensure colour accuracy, due to the limitations of colour printing, please refer to product samples for colour matching.

E.&O.E.

REN320-24/05



CALL **0113 250 4499**

VISIT **RCA-UK.COM**



GET IN TOUCH!



SCAN HERE TO VISIT
OUR WEBSITE TO
CONTACT US AND
OPEN AN ACCOUNT.

FOLLOW US.



FANCY A
SAMPLE?

ASK OUR FRIENDLY
CUSTOMER SERVICE TEAM



PROUD PARTNERS.

WE RAISE FUNDS FOR AN AMAZING CHARITY.



YORKSHIRE
AIR AMBULANCE

TEL **0113 250 4499** • EMAIL **SALES@RCA-UK.COM** • VISIT **RCA-UK.COM**